

MINOLTA

OWNER'S MANUAL

MAXXUM

9000

DATA PANEL

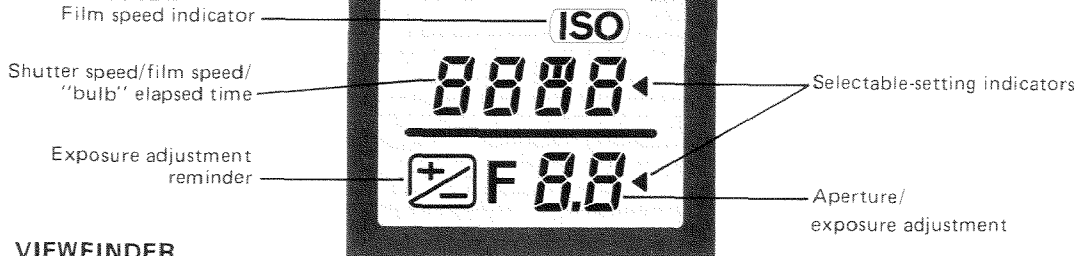

VIEWFINDER

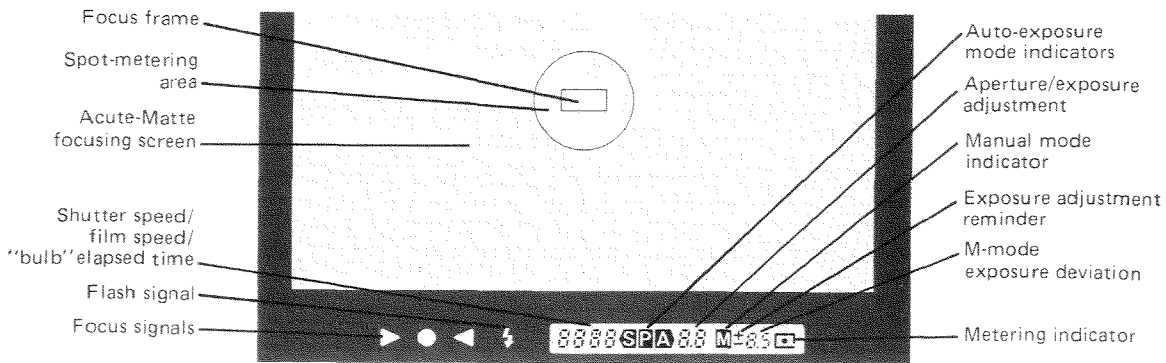

* While all possible displays are shown together here, only applicable displays appear during operation.

NAMES OF PARTS



The MAXXUM 9000 is designed to help you develop your full creative potential. It incorporates sophisticated electronics for unmatched performance and versatility.

Among the MAXXUM 9000's major features are: continuous autofocus that responds instantly while the operating button is touched; built-in spot metering to handle difficult lighting as well as center-weighted metering for general photography; program mode with auto multi-program selection that sets an AE program to match the focal length in use; aperture- or shutter-priority AE and metered-manual modes for creative control; a top shutter speed of 1/4000 sec. and maximum flash X-sync speed of 1/250 sec.; and both TTL flash metering and depth-of-field preview are possible in all exposure modes.

Advanced MAXXUM system accessories include: the Motor Drive MD-90; the MAXXUM Flash 2800AF and 4000AF; the Program Back 90 and Super 90; and the MAXXUM AF lens system that covers focal lengths from 24mm wideangle to 300mm telephoto and includes five lightweight macro/zooms. These and other accessories are described at the back of this manual.

Before using your new camera, carefully read this manual. As you do, attach the lens, load batteries, switch on power, and learn about the camera's parts and features. Then load it with film and proceed to actual picture-taking. Be sure to follow the instructions, and keep this manual handy for further reference. This way you can get better pictures and take full advantage of the advanced features built into your MAXXUM 9000.

Fold out the front and back covers of this manual for easy reference to names of parts.

TABLE OF CONTENTS

Summary of operation	2	Fundamentals of exposure control	40
Attaching lens.	8	Center-weighted metering	42
Batteries and power.	10	Using auto-exposure lock	43
Main switch	13	Spot metering.	44
Operating button.	13	Midtone readings.	45
Loading film.	15	Shadow readings	46
Setting film speed	19	Highlight readings	47
Rewinding film	21	Exposure adjustment	48
Autofocusing	22	Accessory shoe and sync terminal.	51
Using focus hold	23	Self-timer operation and	
Manual focusing	24	tripod mounting	52
Program mode	26	Multiple exposures.	54
Using program shift	28	Eyepiece adjustment and	
Aperture-priority mode	30	eyepiece shutter	55
Shutter-priority mode	32	Other focusing methods	56
Metered-manual mode	34	Accessories.	58
“Bulb” operation	36	Technical details	68
Aperture and shutter settings.	37	Care and storage	70
Depth-of-field.	38	Attaching strap and case	72
Using preview switch	39		

SUMMARY OF OPERATIONS

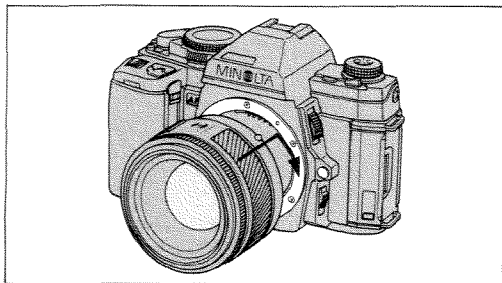

1. Attach lens. Remove body cap and lens caps, align mounting indexes, insert lens into mount, and twist lens clockwise to lock it onto mount (p. 8).

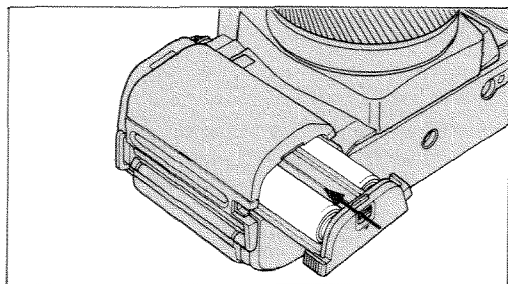

2. Install batteries. Two AA-size batteries are required. Alkaline-manganese, nickel-cadmium, or carbon-zinc batteries can be used (p. 10).

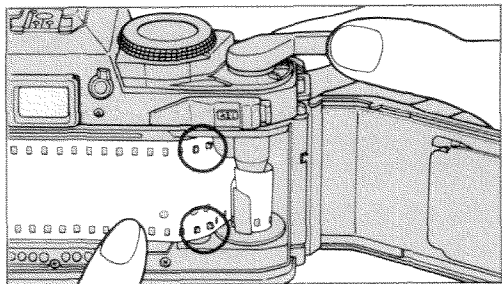

3. Load film. With main switch on, place cartridge in film chamber. After threading leader into take-up spool, advance film to take up slack. Then close back cover (p. 15).

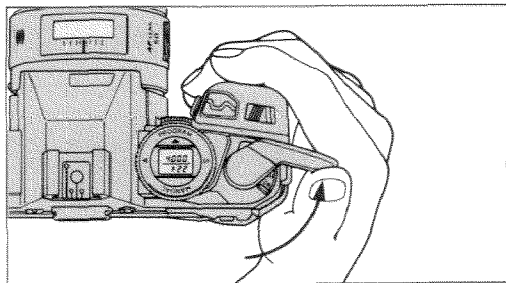

4. Advance film to first frame. Shutter is set at 1/4000 until "1" appears in frame counter. When film is loaded and advancing properly, center of rewind crank rotates counterclockwise during advance stroke (p. 16).

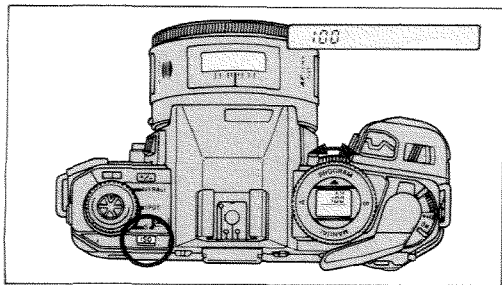

5. Set film speed. Speed for DX-coded films is set automatically. To set film speed for non-DX films, move shutter up/down control while pressing "ISO" key (p. 19).

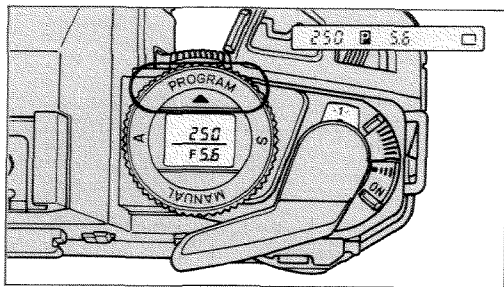

6. Set exposure mode. For general photography, program mode with automatic multi-program selection can be set by rotating exposure mode selector to "PROGRAM" (p. 26).

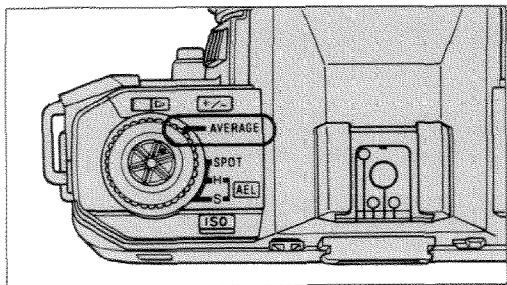

7. Set metering mode. For general photography, "AVERAGE" setting should be used. When lighting conditions require further control, use the camera's built-in spot metering for midtone (SPOT), highlight (H) , or shadow (S) readings (p. 42).

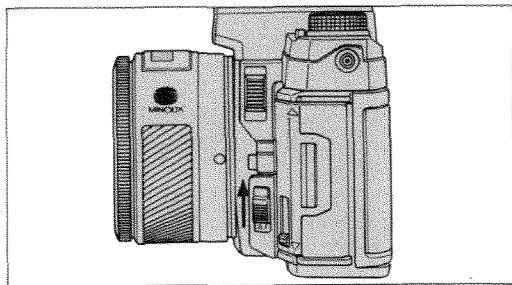

8. Set focus mode. For continuous autofocus-ing, slide focus mode switch to "AF" position. For manual focusing, set switch to "M" position (p. 22).

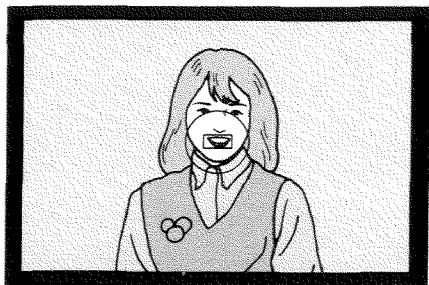

9. Focus camera. Center focus frame on subject and touch operating button to activate camera's continuous autofocus system. Camera continues to adjust focus as long as button is touched. To lock focus, press and hold operating button halfway down (p. 22).

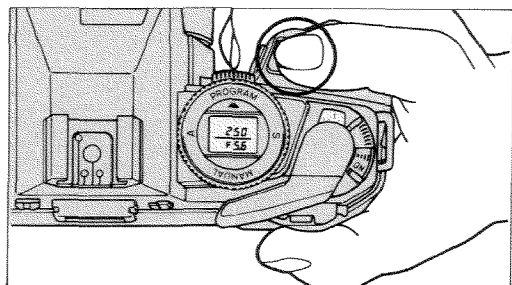

10. Meter subject. Camera's meter is also switched on by touching operating button. Metering continues for ten seconds after finger is lifted from button, then switches off automatically. In auto-exposure modes (P, A, and S), AE lock can be used to hold exposure settings while you recompose photo (p. 13).

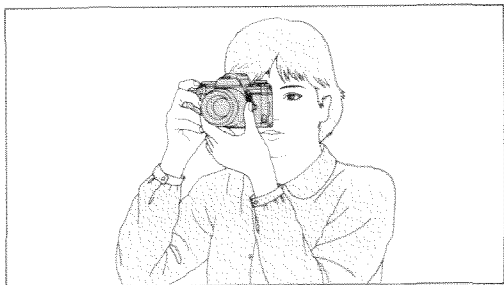

11. Release shutter. While holding camera as shown for horizontal or vertical photographs, press operating button all the way down using a smooth, steady stroke. After exposure, advance film to the next frame (p. 13).

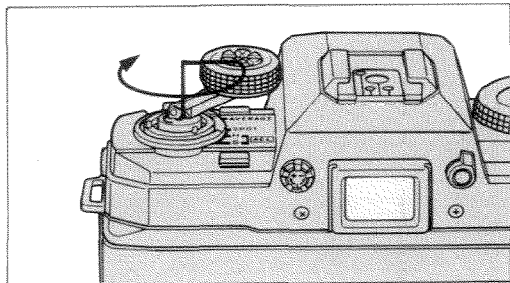

12. Rewind film. At end of roll, press film release. Pull up metering selector, move it to the rewind-crank position, and rewind film into cartridge. Open back cover by sliding lock release while pulling up on rewind crank. Remove film (p. 21).

ATTACHING AND REMOVING LENS

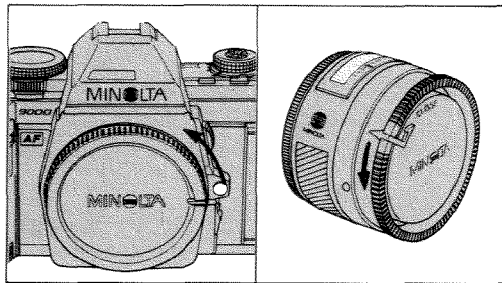

To attach:

1. Remove body cap and rear lens cap as shown.

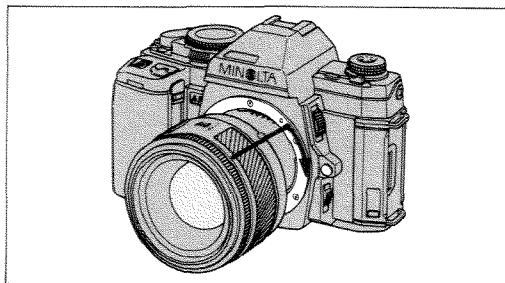

2. Align mounting index (red bead) on lens barrel with mounting index (red dot) on lens mount.

3. Insert lens bayonet into mount and turn lens clockwise until it locks in place with a click.

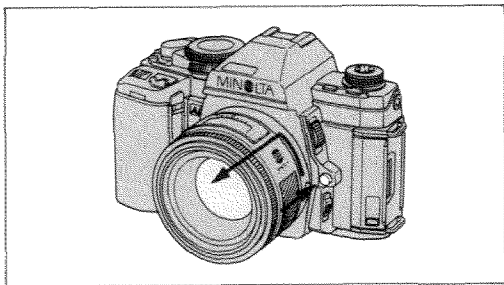

To remove:

While pressing lens release, turn lens counterclockwise as far as it will go, then lift lens out of mount. When camera's meter is on and lens is removed, aperture display shows " - - -".

NOTE

- When attaching or removing lenses, never touch anything inside the camera, especially the lens contacts or mirror.
- To protect lens contacts and lens elements, always attach body cap and lens caps whenever lens is not attached.

Care of glass surfaces

- Never touch lens elements or eyepiece with your fingers. If the lens becomes dirty, clean it gently with a lens brush. Only if necessary, moisten a sheet of lens tissue with one drop of lens-cleaning fluid. Then, starting at the center, use a circular motion to lightly wipe the glass surface.
- Never lift the mirror or touch its surface, as this may impair its alignment. Dust specks on the mirror's surface will not affect meter readings or picture quality; if they are annoying, have the camera cleaned at an authorized Minolta service facility.

BATTERIES AND POWER

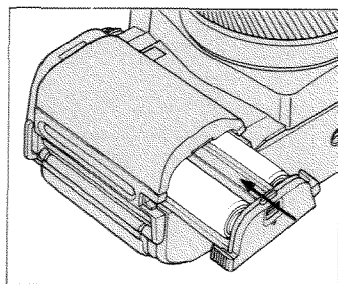
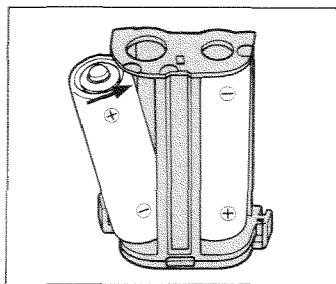
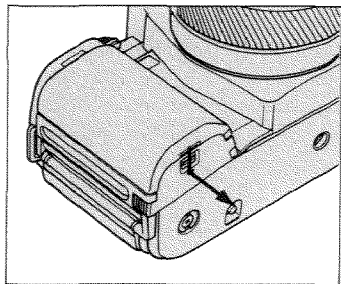

The MAXXUM 9000 uses two AA-size batteries which supply power for autofocus, metering, and shutter release. Either alkaline-manganese, nickel-cadmium, or carbon-zinc batteries can be used. **To load batteries:**

1. Set main switch to OFF, then remove battery holder by sliding release tab in direction shown and pulling holder out.

2. Place new batteries in holder with plus (+) and minus (-) ends as indicated.

3. Slide holder back into handgrip and press on base of holder to snap it into place.

NOTE

- To prevent damage from battery leakage or bursting, never mix batteries of different types, brands, or ages.
- If camera will not be used for more than two weeks, batteries should be removed.
- Used batteries should not be disposed of in fire.
- Keep batteries away from young children.

Battery check

To check battery condition: Set main switch to ON position, then touch or slightly press operating button. If LCDs start blinking, battery power is getting low and fresh batteries should be installed.

Low-power indications

Fresh batteries should be installed in any of the following cases:

- When LCDs in viewfinder or on camera body blink.
- If shutter will not release or if shutter speed and aperture are not displayed when operating button is touched.
- When autofocus will not operate or its operation is extremely slow.

Cold-weather operation

Performance of batteries tends to decrease as they become colder. Before using the camera in cold weather, make sure fresh batteries are loaded. A spare set should be carried in a warm pocket, in case you need to change batteries while shooting. Battery capacity will be restored as their temperature rises.

For prolonged cold-weather use at approx. 0°C (32°F) or lower, use of AA-size nickel-cadmium batteries is recommended.

Memory storage

The following settings are stored in the camera's memory as long as fresh batteries are installed in the camera: exposure adjustment, film speed, and manual exposure settings.

Whenever the battery holder is removed and reinserted: exposure adjustment is set to ± 0.0 , film speed is set to either the ISO setting for DX-coded film in use or ISO 100 for non-DX films, and manual exposure settings are reset to 1/250 sec. and f/5.6.

MAIN SWITCH

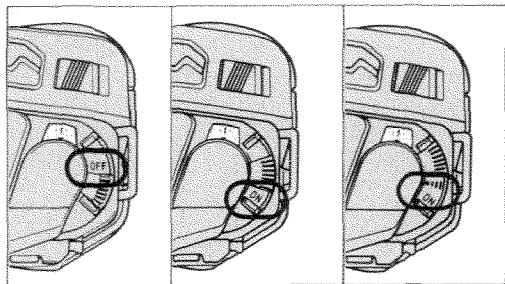

The main switch should be set to OFF position when camera is not in use. This will prevent battery drain or accidental release of the shutter. To operate camera, move main switch to ON or ON (M) position.

At ON (M) position, the camera gives audible beeps when subject is brought into focus (with focus hold engaged) and during self-timer operation.

OPERATING BUTTON

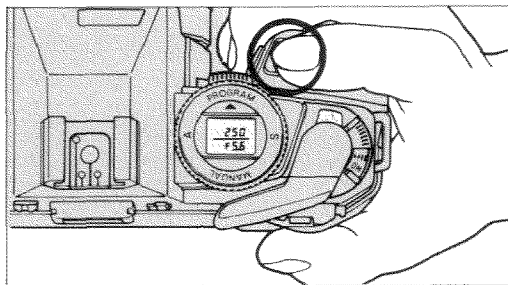

The MAXXUM 9000's operating button is used to release the shutter and features a touch-sensitive switch for activating the meter and autofocus systems. To conserve battery power, the operating button functions only when main switch is set to ON or ON (M).

Meter activation

To activate the meter, touch the operating button. In low light, the LCD panel in the viewfinder is automatically illuminated. For easier operation of other controls, meter remains on for 10 seconds after lifting your finger from button.

Autofocusing

The camera's autofocus system is activated whenever the operating button is touched. The camera will continuously adjust focus on the subject in the focus frame as long as your finger remains on the operating button. To hold focus, press operating button halfway, recompose photo, and release shutter.

For a detailed explanation of how to use the autofocus system, refer to pages 22 to 25.

Shutter release

After focusing, release shutter by pressing operating button all the way down in a smooth, steady stroke. Never use a quick jab, which may shake the camera and result in blurred pictures.

NOTE

- If operating button becomes dirty or oily, set main switch to OFF and wipe button with a clean, dry cloth.
- When proper contact is not possible (e.g., when fingers are very dry or when wearing gloves), slightly press button to activate metering and autofocusing.
- Continuous autofocusing is not possible when wearing gloves, since camera's touch switch cannot be activated.

FILM LOADING

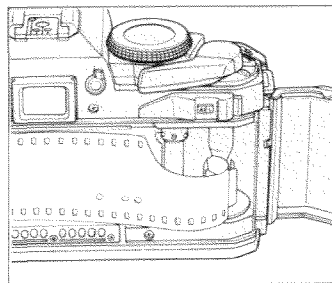
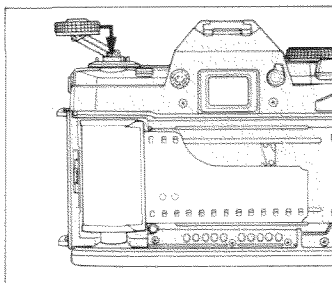
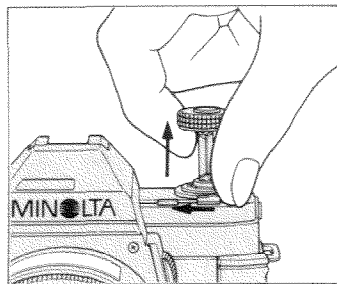

1. Switch camera on. Then open back cover by pulling up on back release while sliding lock release to the right.

2. After placing film cartridge in film chamber, push back release all the way in. (If release will not go all the way in, move release to its rewind-crank position and rotate it slightly to the right or left; see p. 21.)

3. Slide tip of film leader into a slot in the take-up spool. Make sure film does not protrude from another slot. Also check that a tooth on the take-up spool aligns with a hole in edge of film.

Right

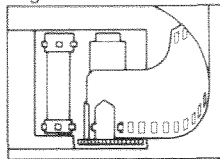

Wrong

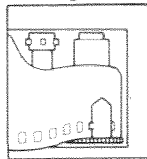

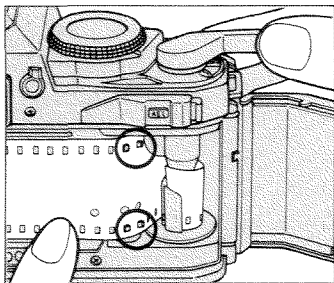

4. While holding film against sprocket with your left hand, release shutter and operate film advance lever until film is wound firmly around take-up spool. Make sure that teeth in sprocket engage holes in both edges of film, and that slack in film is taken up.

5. After making sure film is taut, close back cover by pressing until it clicks shut.

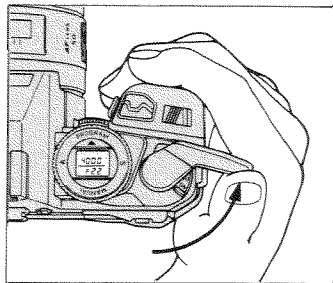
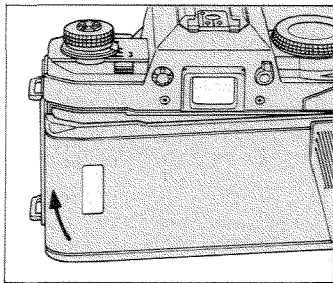

6. Release shutter and advance film until index in frame counter points to "1". During film advance, center of rewind crank will rotate counterclockwise when film is advancing properly. (If it does not rotate during film advance stroke, open back cover and repeat steps 3 to 6.)

NOTE

- Until film has been advanced to the first frame, only the camera's shutter release will operate. Film speed cannot be set until "1" appears in frame counter.
- Until film has been advanced to the first frame, shutter is set to 1/4000 and aperture to lens' minimum aperture.

Film loading precautions

- Always load film in subdued light or at least shaded from direct sunlight.
- Before opening camera back, check if film is loaded by referring to film window. If film is loaded, check that it is completely rewound by rotating rewind crank clockwise until it turns freely.
- Do not touch any parts or areas shown in blue.

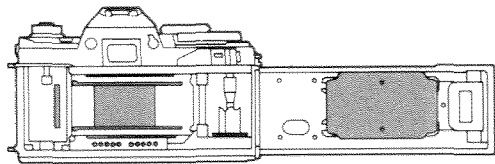

- Make sure films is taut before closing back cover.

Right

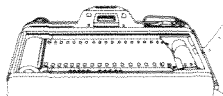

Wrong

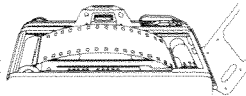

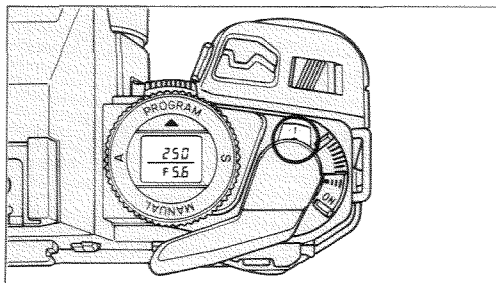

Frame counter

The frame number increases by one with each exposure. Common film lengths (12, 20, 24, and 36 exposures) are marked in red to signal that rolls with those numbers of exposures are almost finished. Film advance may stop before the number of exposures marked on the roll. Do not force the film-advance lever. When film advance is not possible with normal pressure, rewind film.

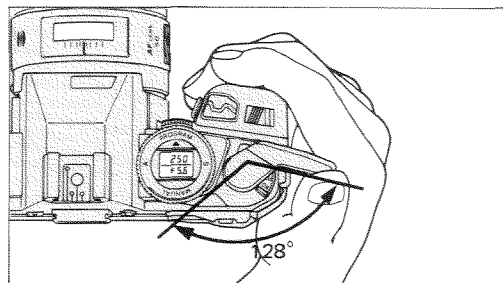

Film-advance lever

The film advance lever swings out away from the camera body so you can slip your right thumb behind it. After exposure, advance film by moving lever 128° in direction shown. This can be done in a single stroke or several short strokes.

After film is advanced to the first frame, film-speed setting is automatically displayed in the data panel. If setting is the one you want, touch operating button. You are now ready to take pictures.

SETTING FILM SPEED

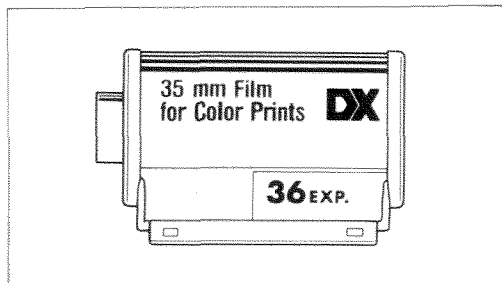

Automatic setting with DX-coded films

When DX-coded film is loaded, camera automatically displays the film's ISO rating after film is advanced to the first frame. To manually set film speed to a higher or lower rating, refer to the following section.

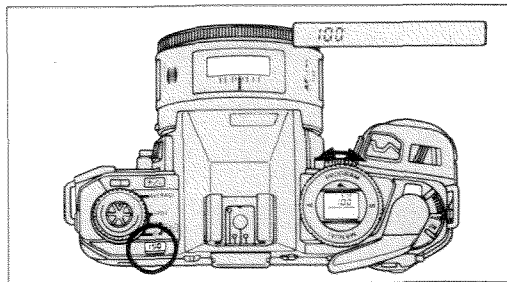

Manual setting of film speed

When non-DX film is loaded, film-speed setting from the previous roll is displayed. Film speed can be set manually by pressing film-speed key (marked ISO) and moving shutter up/down control to increase or decrease the displayed value. Each time control is moved, setting changes by 1/3 stop. After film speed is set, release ISO key and camera is ready to operate. Film-speed setting can be checked at any time by pressing ISO key.

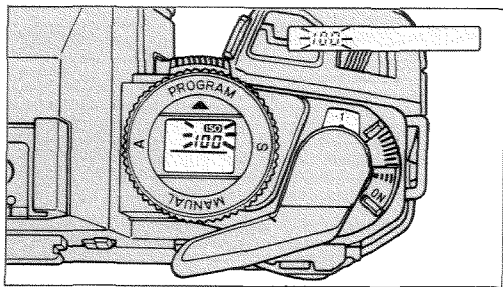

CAUTION

With non-DX films, anytime the battery holder is removed and reinserted, film-speed setting reset to "ISO 100" which blinks rapidly in the data panel, and shutter cannot be released. Before camera can be operated, desired film speed must be reset manually as explained earlier. For DX-coded films, if the displayed setting is correct, just touch the operating button and the camera can be operated.

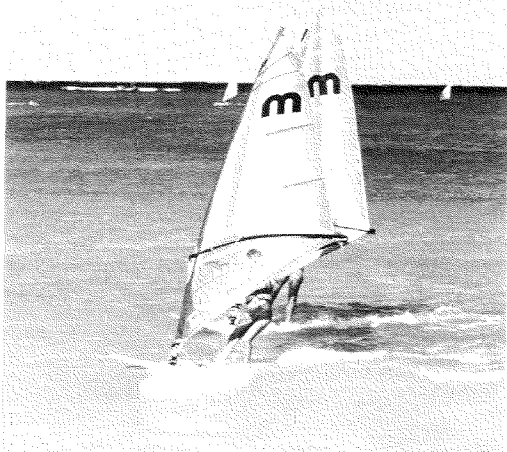

REWINDING AND UNLOADING FILM

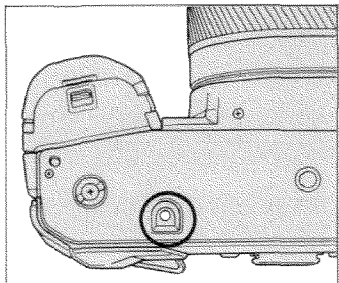

1. At the end of the roll, press rewind release on camera bottom.

2. Pull metering selector up and move it to its rewindcrank position. Wind film into its cartridge by rotating crank clockwise until it turns freely with no resistance.

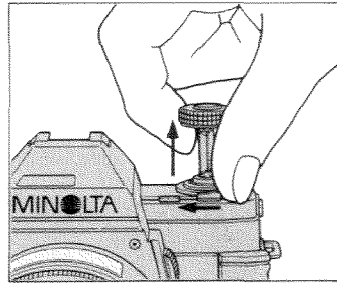
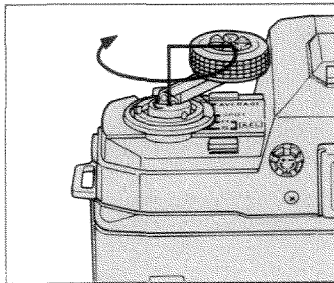

3. Open back cover and remove film cartridge.

FOCUSING



Continuous autofocusing

1. Set focus mode switch to its AF (autofocus) position.
2. Center focus frame on subject.
3. Rest finger on operating button. The camera will adjust focus continuously as long as operating button is touched. When subject comes into focus, the green focus signal in the viewfinder glows.
4. Release shutter by pressing operating button all the way down.

NOTE

- Shutter can be released at any time whether subject is in focus or not. Make sure subject is focused as desired before releasing shutter.
- If illumination is too low or if subject cannot be autofocused, both red focus signals will blink to indicate that manual focusing is necessary.

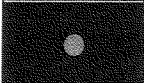
Focus signals during autofocusing

	Too close to subject
	In focus
	Focus manually on Acute-Matte screen

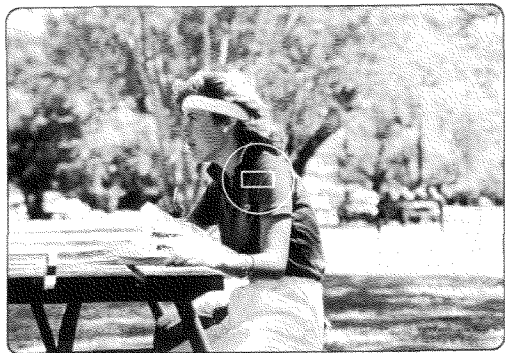

Focus hold: Center focus frame on subject, then press and hold operating button halfway down. When subject is in focus, the green focus signal glows and camera “beeps” (if at ON  position).





Focus is held as long as operating button is pressed halfway. Recompose photo with subject anywhere in frame and release shutter.

Manual focusing

1. Set focus mode switch to its M (manual) position.
2. Center focus frame on subject.
3. Touch operating button to activate focus signals.
4. Turn focusing ring in direction indicated by red focus signals in viewfinder. Green focus signal glows when subject is in focus and camera "beeps" (if at ON|**1**) position). When both red focus signals blink, subject must be focused visually on the Acute-Matte focusing screen. To do so, turn focusing ring until subject appears sharpest in the viewfinder.
5. Release shutter by pressing operating button all the way down.

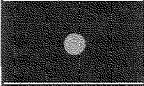
Focus signals during manual focusing

	Turn focusing ring to the right.
	In focus
	Turn focusing ring to the left.
	Focus manually on Acute-Matte screen.

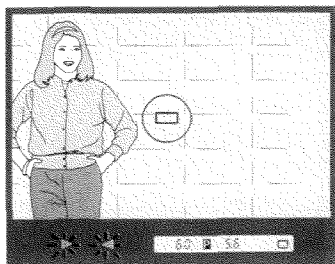

A

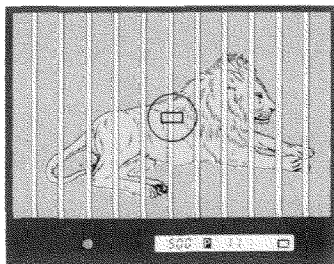

B

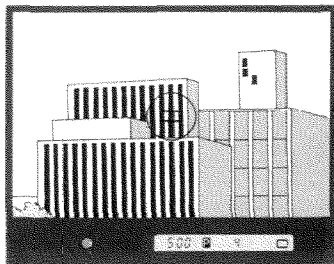

C

Autofocusing in special situations

In situations where red LEDs blink or the green LED glows but the subject does not appear sharp, additional care should be taken to assure accurate focus:

- If subject contrast is too low (A), use focus-hold to lock focus on another subject at the same distance, then recompose photograph and release shutter.

- In cases where two subjects are at different distances within the focus frame (B) or where parallel lines interfere with autofocusing (C), focus manually on Acute-Matte screen.

- When light is too low for the autofocus system to respond, a Minolta MAXXUM Flash can be used.

- For extremely bright subjects, use of a neutral-density filter is recommended.

PROGRAM MODE

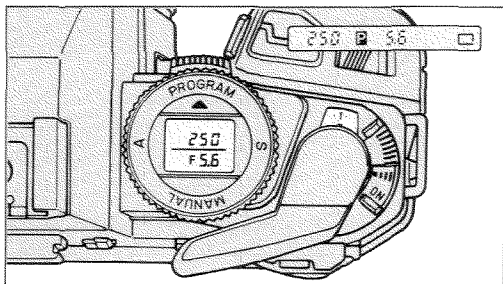

Program (P) mode is ideal when you just want to compose and shoot. This mode features automatic multi-program selection (AMPS) which instantly matches the exposure program to the focal length in use. In this mode, both aperture and shutter speed are set automatically and displayed in the viewfinder and data panel.

To set mode: Rotate exposure mode selector to align "PROGRAM" with index on data panel.

Auto multi-program selection (AMPS)

In Program mode, one of three programs is automatically selected to match the lens focal length actually in use.

Shorter than 35mm:

Wide program sets the smallest practical aperture for maximum depth of field.

35mm to 105mm:

Standard program is Minolta's faster-speed type that sets optimum shutter speeds and apertures.

Longer than 105mm:

Tele program sets faster shutter speeds to protect against blur from camera shake.

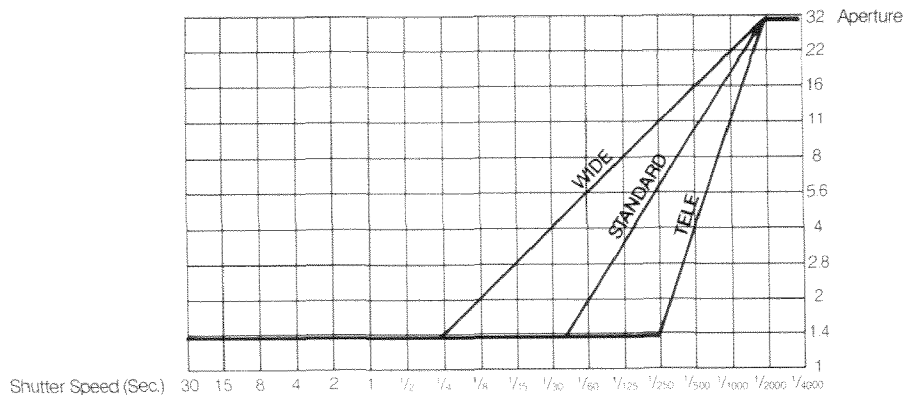

NOTE

- Program selection is automatic; it is not possible to manually select a specific program.
- With zoom lenses, the program automatically changes as you zoom from one range to the next. With the AF 28-135mm zoom, for example, as you zoom from 28mm to 135mm, the program changes from Wide through Standard to Tele.

- If light level is outside metering range, metering indicator in viewfinder blinks as a warning that exposure may not be correct.
- If both shutter speed and aperture displays blink, required aperture-shutter speed combination is not available.

Program shift

While remaining in Program mode, program shift can be used to temporarily select alternative aperture-shutter speed settings. Shifting the program does not change total exposure; it only changes the combination of settings used for achieving the same exposure. For example, if the program is shifted to use a faster shutter speed, the camera will automatically set a larger aperture to balance it and maintain the same relative exposure.

Using program shift

To shift the program, move the shutter or aperture up/down control until the desired shutter or aperture setting appears in the viewfinder and data panel. Settings change in half-stop increments, and "P" in the viewfinder blinks to indicate when program shift is in use. Before exposure, shifted settings are held for ten seconds after lifting finger from operating button. After exposure, program shift is cancelled as soon as finger is lifted from operating button.

NOTE

- To make several exposures using program shift, keep finger on operating button between exposures.
- When using zoom lenses, it is best to shift program after zooming. When zooming from 70mm to 210mm, for example, program changes from Standard to Tele, and the shifted settings will also change.

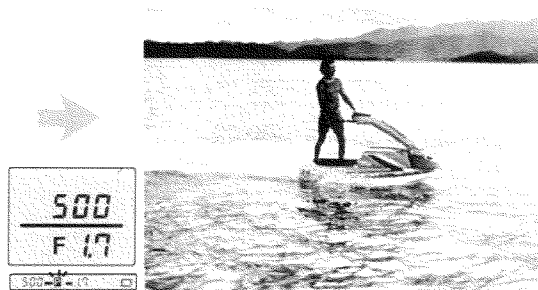
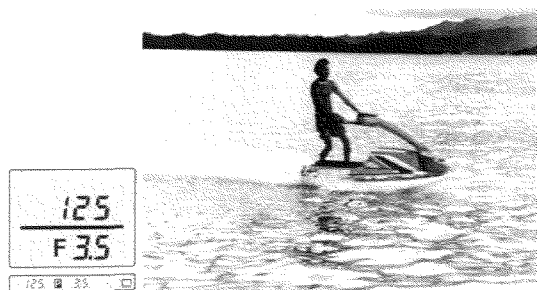
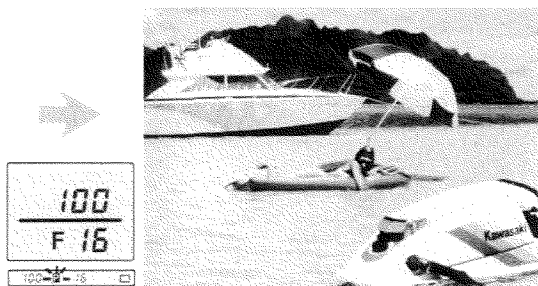
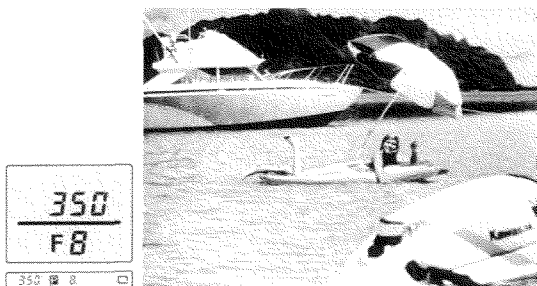

APERTURE-PRIORITY (A) MODE

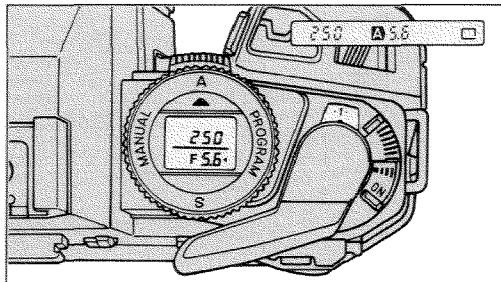

To set mode: Rotate exposure mode selector to align “A” with index on data panel. A small pointer appears next to the aperture setting to indicate that it can be set manually.

To set aperture: Move either aperture or shutter up/down control until desired aperture is shown in data panel and viewfinder. Each time you move an up/down control, aperture will change by 1/2 stop. Aperture changes rapidly when control is held in either direction.

Any available aperture from the range indicated on the front of the lens can be set.

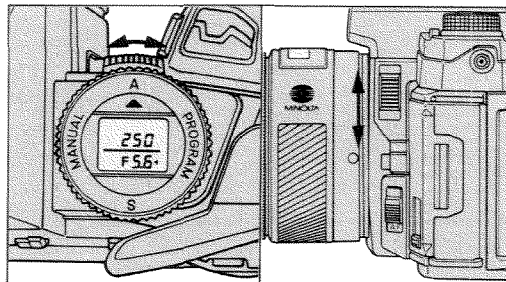

The AF 50mm/1.7 lens, for example, is marked 1:1.7 (22) indicating a range of f/1.7 to f/22.

NOTE

- Shutter speed display blinks when the speed required is outside the coupled range. If “4000” blinks, set smaller apertures until blinking stops. If “30” blinks, set a larger aperture until blinking stops.
- If light level is outside metering range, metering indicator in viewfinder blinks as a warning that exposure may not be correct.

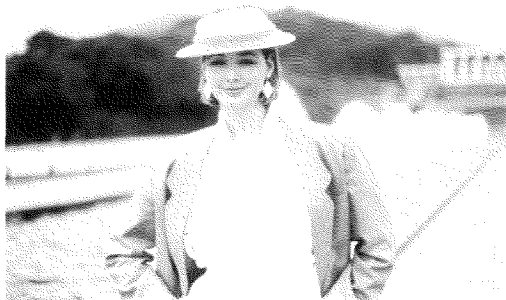

A. Large aperture

Creative aperture control

In A mode, you select the aperture and the camera automatically sets the shutter speed required for proper exposure. This mode should be used when you want to control the range of sharpness (i.e., depth of field) in a photograph, as for making a large part of the scene sharply focused or emphasizing a subject against an out-of-focus background.

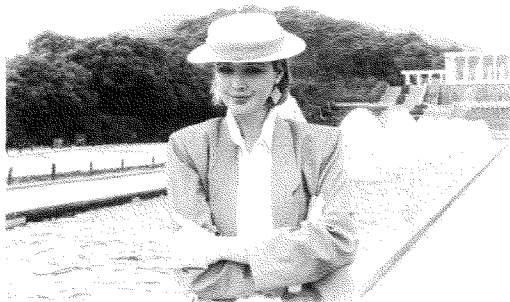

B. Small aperture

A. Large apertures (i.e., small f-numbers such as $f/2$ or $f/3.5$) yield a shallow field of sharp focus. **B.** Small apertures (i.e., large f-numbers such as $f/11$ or $f/16$) give greater depth of field.

Refer to page 38 for further information about controlling depth of field and using the preview switch.

SHUTTER-PRIORITY (S) MODE

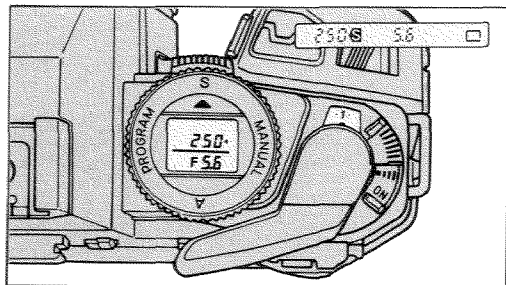

To set mode: Rotate exposure mode selector to align "S" with index on data panel. A small pointer appears next to the shutter speed setting to indicate that it can be set manually.

To set shutter speed: Move either shutter or aperture up/down controls until desired shutter speed is shown in data panel and viewfinder. Any available shutter speed from 1/4000 sec. to 30 seconds can be set. Each time you move an up/down control, shutter speed will change by one stop. Shutter speed changes rapidly when control is held in either direction.

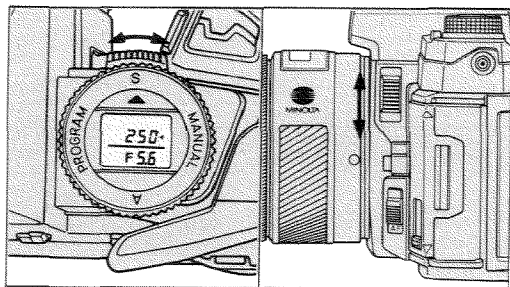

NOTE

- In S mode, do not use "bulb" setting, which appears after the 30 sec. setting. "Bulb" should only be used in M mode.
- If lens' maximum aperture (e.g., f/1.7) blinks, set slower shutter speeds until blinking stops. If minimum aperture (e.g., f/22) blinks, set faster shutter speeds until blinking stops.
- If light level is outside metering range, metering indicator in viewfinder blinks as a warning that exposure may not be correct.

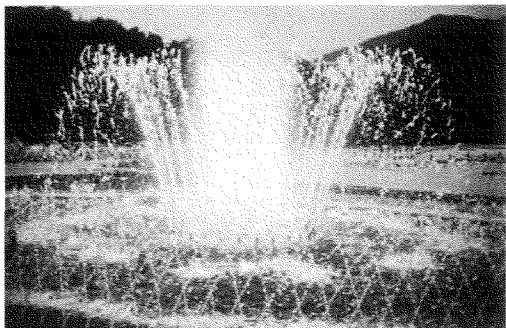

A. Fast shutter speed

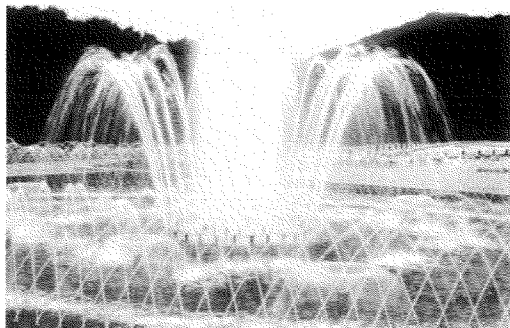

B. Slow shutter speed

Creative shutter-speed control

S mode is very useful when photographing moving subjects. You can set fast shutter speeds to render the subject sharp, or slow speeds to intentionally blur its movement. When using telephoto lenses, faster speeds can be set prevent image blur caused by camera movement. After setting the shutter speed, the camera automatically selects the aperture required for correct exposure.

- A. Fast shutter speeds, such as $1/500$ to $1/4000$ sec., can be used to "stop" action.
- B. Slow shutter speeds, such as $1/15$ sec. or slower, can be used to blur subject movement.

METERED MANUAL (M) MODE

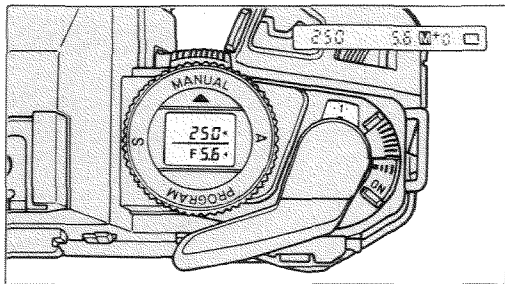

In M mode, you have full creative control of exposure. Exposure can be based on the camera's TTL meter, an external meter, or your own experience. Any available shutter speed and aperture can be set, with both settings displayed in the viewfinder and data panel.

To set mode: Rotate exposure mode selector to align "MANUAL" with index on data panel. Small pointers appear next to the shutter speed and aperture settings to show that both can be set manually.

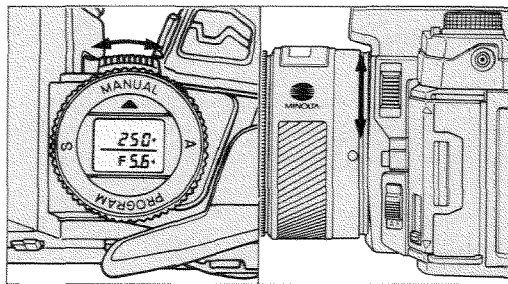

To set aperture and shutter speed: Use aperture up/down control to set aperture in half stops and shutter up/down control to set shutter speed in full stops.

To adjust exposure: With meter on in M mode, the exposure-deviation indicator appears in viewfinder. For normal exposure based on the camera's TTL meter, adjust the up/down controls as indicated in viewfinder. Some typical readouts are:



"-0" or "+0" indicates exposure is set within $\pm 1/4$ stop of normal exposure.



"+2" indicates exposure is set for two stops (i.e., four times) greater than required for a normal exposure.

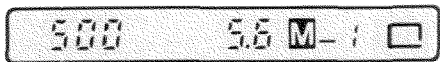

"-1" indicates exposure is set for one stop (i.e., one half) less than required for normal exposure

NOTE

- If light level is outside metering range, metering indicator in viewfinder blinks as a warning that exposure may not be correct.
- If exposure adjustment is set with camera in M mode, +/- mark will not appear in data panel; however, indication for normal exposure includes the set value. For example, if exposure would normally be 1/60 sec. at f/5.6, when exposure adjustment is set to +1.0, meter indicates normal exposure to be either 1/60 at f/4 or 1/30 at f/5.6.

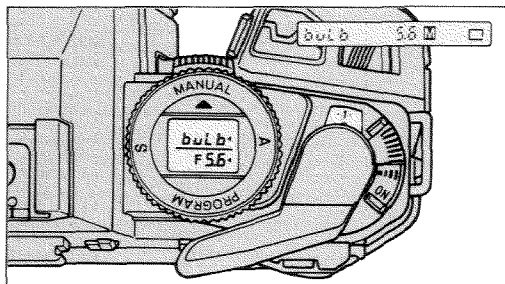

Long exposures ("bulb" setting)

With camera in M mode, move shutter up/down control until "bulb" appears (after "30'") and set aperture as desired. Focus lens and release shutter. To avoid shaking the camera, mount it on a sturdy support such as a tripod and use the optional Remote Cord RC-1000S or RC-1000L to release the shutter. Shutter remains open as long as operating button is pressed. Elapsed exposure time (in seconds) is shown in the data panel. After 99 seconds, counter returns to "0" and continues counting.

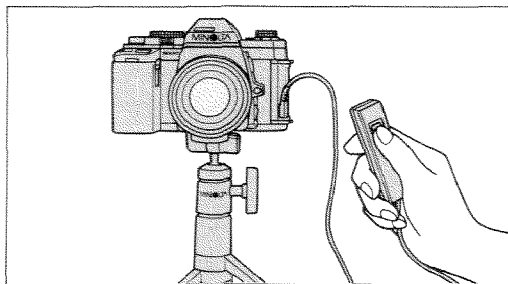

NOTE

- Self-timer operation is not possible at "bulb" setting.
- The maximum exposure time depends on battery capacity: With fresh alkaline-manganese batteries, it will be approx. 8 hours.

APERTURE AND SHUTTER-SPEED SETTINGS

1.7

2

2.4

2.8

3.5

4

4.5

5.6

6.7

8

9.5

11

13

16

19

22

Aperture settings

Table at left shows aperture settings that are displayed in each mode with the 50mm f/1.7 lens. Numbers such as 6.7 and 9.5 are half-stop settings between whole f-stops. Thus, for example, the half-stop setting between f/8 and f/11 is f/9.5.

Shutter-speed settings

Table at right shows shutter-speed settings that are displayed in P and A modes. In M and S modes, only the speeds in full stops can be set. Numbers such as 750 and 350 are the half-stop indications between the standard shutter speeds. Thus, for example, the half-stop indication between 1/1000 sec. and 1/500 sec. is 1/750 sec.

Indications for speeds from 1/4000 sec. to 1 sec. are: 4000 = 1/4000 sec., 2000 = 1/2000 sec., etc. Speeds from 0.7 sec. to 30 sec. are indicated: 0"7 = 0.7 sec., 1" = 1 sec., etc.

NOTE

"Bulb" setting should be used only in M mode.

4000 — 3000

2000 — 1500

1000 — 750

500 — 350

250 — 180

125 — 90

60 — 45

30 — 20

15 — 10

8 — 6

4 — 3

2 — 0"7

1" — 1"5

2" — 3"

4" — 6"

8" — 12"

15" — 22"

30"

bulb

DEPTH OF FIELD

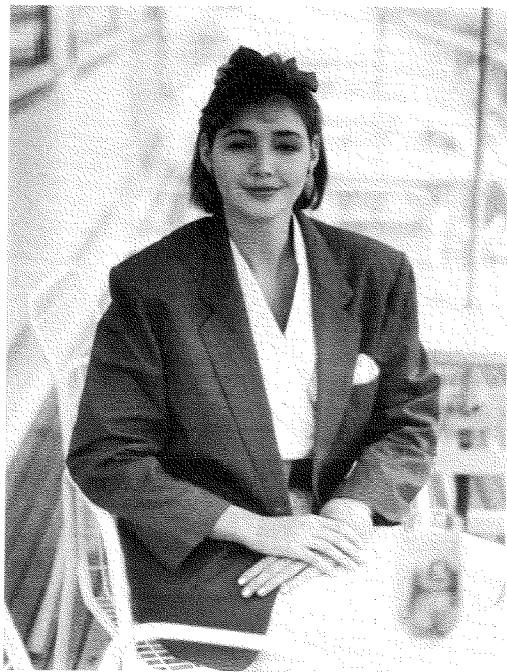

A. Large aperture



B. Small aperture

When a lens is focused on a subject, there is a certain range behind and in front of the subject that appears sharp. This range is called "depth of field", and one way to control it is to adjust the aperture. The photos show how depth of field varies with the aperture selected:

A. Large apertures (e.g., $f/1.7$) yield a shallow field of sharp focus, rendering the background and foreground unsharp; **B.** Small apertures (e.g., $f/22$) yield greater depth of field with more of the scene in focus. Refer to depth-of-field scale on the lens to determine approximate depth of field. To check more closely, use preview switch on camera body.

At a given aperture and focal length, depth of field also varies with subject distance: When the lens is focused on a close subject, depth of field is less; when focused on a distant subject, depth of field is greater.

Preview switch

The preview switch can be used in all exposure modes to close down and lock the lens' aperture. This enables you to determine

whether depth of field is sufficient. The switch is hinged and folds up against the handgrip when not in use. **To use:**

1. Focus on main subject.
2. In A or M mode, set desired aperture. In P or S mode, meter scene in the usual way.
3. With film advanced, press preview switch partway down and release it. Lens aperture will now be locked at the setting displayed in the data panel. Also, "F" blinks in data panel while preview switch is used.
4. Look through the viewfinder to determine depth of field. When lens is closed down, autofocus does not operate and it is not possible to adjust aperture setting. Also, image in viewfinder may appear dark, but this has no effect on exposure.
5. To cancel preview operation: Press preview switch all the way down and release it. Aperture setting can now be adjusted by using the up/down controls. Preview operation is cancelled automatically if shutter is released with lens stopped down.

FUNDAMENTALS OF EXPOSURE CONTROL

To obtain correct exposure for the subject's brightness and film being used, the aperture (size of the lens opening) and shutter speed (length of time the shutter is open) must be controlled.

As indicated by the aperture diagram next to each f-number in the diagram, large f-numbers (e.g., f/16 and f/11) represent small apertures, and small f-numbers (e.g., f/2 and f/1.4) represent large apertures. Each standard f-number setting (e.g., f/8) lets in twice as much light as the next larger one (f/11) and half as much as the next smaller one (f/5.6). This difference in exposure between standard f-numbers is called one "stop".

Shutter speeds are expressed in seconds or in fractions of a second as the reciprocal of numbers shown on the shutter speed display. Each standard shutter speed (e.g., 1/60 sec.) allows light to strike the film twice as long as the next faster one (1/125). This exposure difference between standard shutter speeds is also called one "stop".

Total exposure on the film is determined by the combination of aperture and speed. Using the next smaller f-number (i.e., giving one stop more exposure) will balance using the next faster shutter speed (i.e., giving one stop less exposure), and so on. A great range of combinations (f/5.6 at 1/30, f/4 at 1/60, f/2.8 at 1/125 etc.) will thus yield the same total exposure.

The diagonal lines correspond to exposure values (EV); all of the aperture/shutter-speed combinations indicated by a given line will produce the same exposure. At a particular film speed, the EV increases by one each time the subject brightness doubles, and thus the exposure required will decrease by one stop. On the other hand, when the EV is one unit lower (i.e., when subject is only half as bright), exposure must be increased one stop.)

The film-speed-coupled metering system measures the brightness of the subject and computes the EV needed for proper exposure. This EV is used for setting aperture and shutter speed.

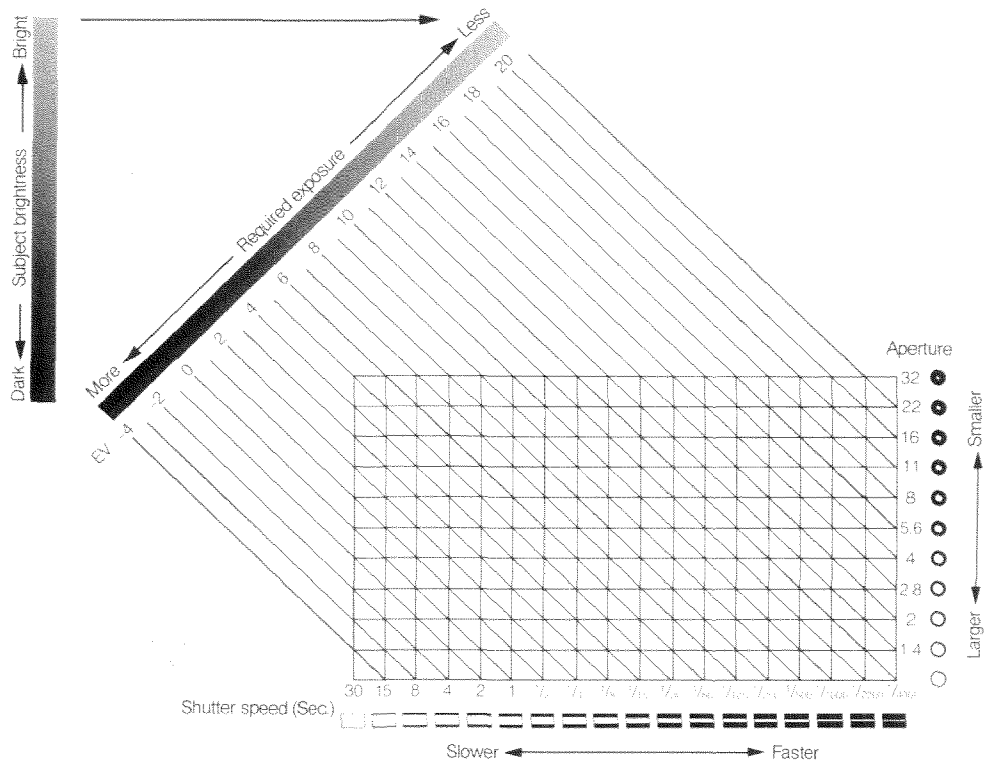

CENTER-WEIGHTED AVERAGE METERING

Center-weighted average metering should be considered the normal metering mode for most picture-taking situations. When the metering selector is set to "AVERAGE" position, exposure is based on an average of the various light values in the scene with additional emphasis (weight) given to the center area. This produces consistent, reliable results in most situations with a minimum of effort.

Center-weighted average-metering pattern

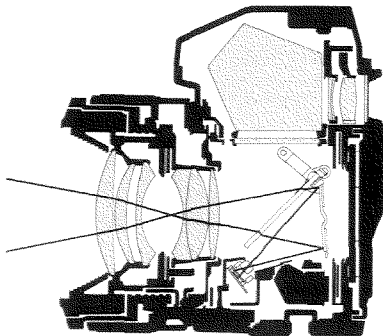
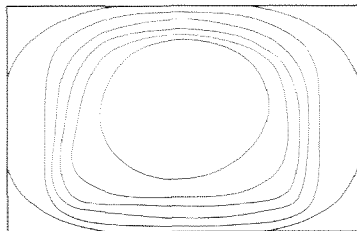

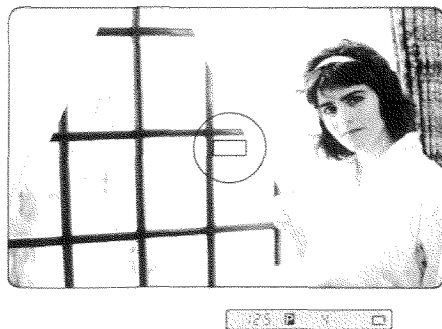

Use of AE lock

This control is used in P, A, or S auto-exposure (AE) mode to hold a meter reading for the main subject while you recompose and release the shutter. AE lock should be used when the main subject is not centered in the frame or when the brightness level between subject and background is very high, such as for backlit or spotlight subjects.

To use:

1. Shift camera's position so subject fills most of frame. For smaller subjects, you may need to move closer (or zoom in).
2. With meter on, press and hold AE Lock (marked AEL).
3. While keeping it pressed, recompose picture, focus, and release the shutter.

SPOT METERING

For most situations, center-weighted average metering is adequate. There are times, however, when the MAXXUM 9000's built-in spot meter should be used to obtain the results desired. Exposure readings based on a midtone value (at SPOT setting) can be used when lighting contrast is very high. When most of the tones in the picture are very light, highlight-based exposures (at H setting) can be made. Shadow-based exposures (at S setting) can be made when most of the scene is consists of darker tones.

When making highlight- or shadow-based exposures in P, A, or S mode, AEL button must be pressed while releasing shutter. If AEL button is not pressed, camera sets exposure to produce a midtone value, even if metering selector is at H or S setting.

Spot-metering pattern

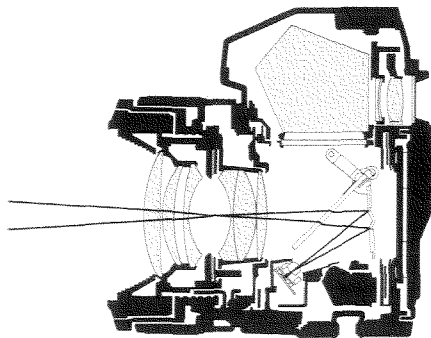
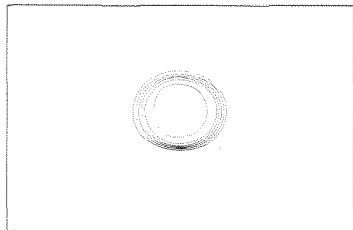

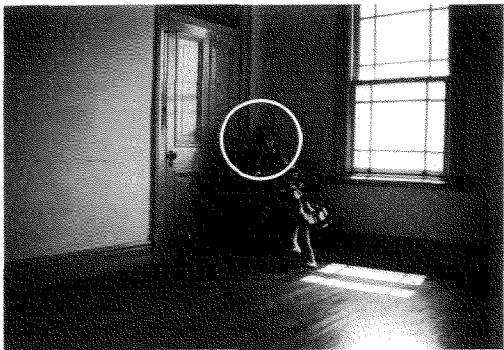

Midtone readings (SPOT setting)

Midtone readings should be used to achieve optimum exposure of subjects with medium tones in high-contrast lighting, such as for backlit subjects with no fill lighting or spotlighted subjects against dark backgrounds. When midtone readings are made, exposure is based on an averaged reading of the subject located in the spot-metering circle. This enables you to obtain correct exposure for the most important area in a photograph.

To use:

1. Set metering selector to "SPOT" position.
2. Position camera so that a midtone area fills spot-metering circle in viewfinder.
3. P, A, or S mode: Press and hold AEL button to lock the meter reading. While pressing AEL button, recompose photo and release shutter.

M mode: Adjust shutter and aperture so that exposure-deviation indicator shows "-0" or "+0". Then recompose photo and release shutter.

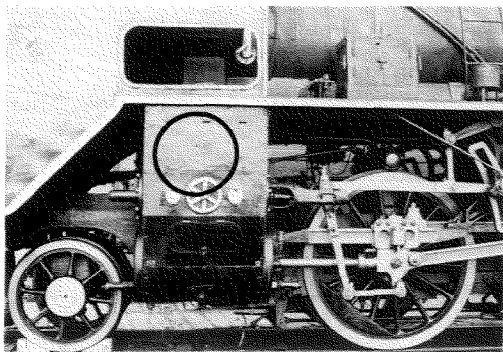

Shadow readings (S setting)

Shadow readings should be used when the most important or largest part of the photo consists of mostly darker tones. If a center-weighted reading (or spot midtone reading) is used, these areas will appear too light, over-exposed. When shadow readings are made, exposure is decreased to properly expose these areas. **To use:**

1. Set metering selector to "S" position.
2. Position camera so that shadow area fills spot-metering circle in viewfinder.

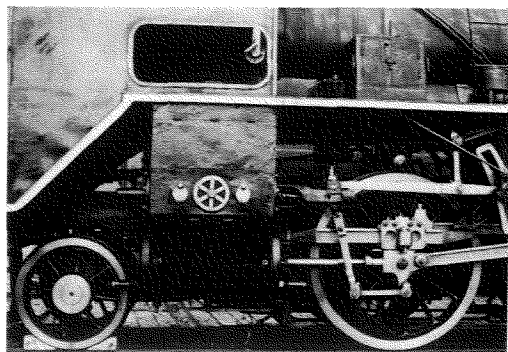

3. P, A, or S mode: Press and hold AEL button. Shutter/aperture settings for exposure of shadow area will now be displayed. While still pressing AEL button, recompose photo, and release shutter.

M mode: While pressing AEL button, adjust shutter and aperture for "-0" or "+0" exposure deviation. Recompose photo and release shutter.

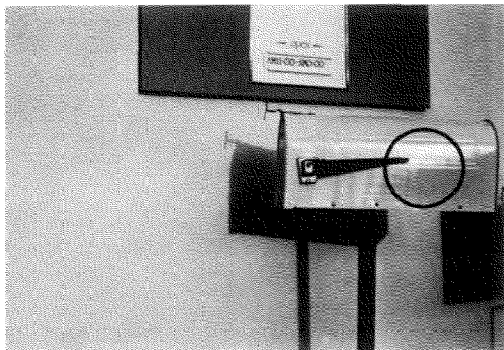

Highlight readings (H setting)

Highlight readings should be used when the most important or largest part of the photo is white or very light-colored. If a center-weighted reading (or spot midtone reading) is used, these areas will appear too dark, under-exposed. When highlight readings are made, exposure is increased so that the lighter areas will be properly exposed. **To use:**

1. Set metering selector to "H" position.

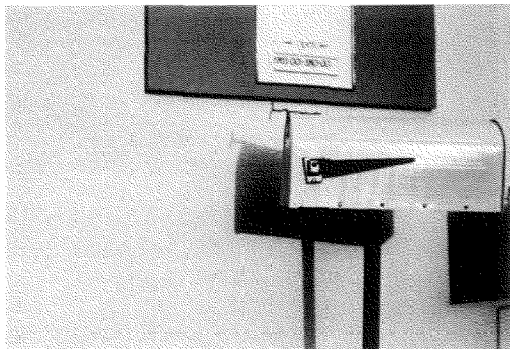

2. Position camera so that a light area fills spot-metering circle in viewfinder.

3. P, A, or S mode: Press and hold AEL button. Shutter/aperture settings for exposure of light area will now be displayed. While still pressing AEL button, recompose photo, and release shutter.

M mode: While pressing AEL button, adjust shutter and aperture for "-0" or "+0" exposure deviation. Recompose photo and release shutter.

WHEN TO USE EXPOSURE ADJUSTMENT

When using center-weighted average metering, the following suggestions will help you decide whether to use exposure adjustment. Individual conditions and intentions will, of course, determine which exposure you choose.

- When background is much brighter than main subject: Set exposure adjustment between +0.5 and +2.0 stops, depending on lighting conditions. Photos A and B were taken with strong backlighting and no fill-in illumination.

- When the main subject is much lighter than the background: Set exposure adjustment between -0.5 and -2.0 stops, depending on lighting conditions. Photos C and D shown main subject in bright sunlight against a dark background. This exposure adjustment can also be used for spotlighted subjects, as at a circus or on a stage.

- For scenes where most of the tones are very light, such as snow-covered hillsides: An adjustment of +0.5 to +2.0 stops may be necessary. Similarly, an adjustment of -0.5 to -2.0 stops can be used when the overall scene is composed of mostly darker tones, as for a black cat against a dark background.

- Exposure adjustment can also be used to vary exposure in half-stops for a series of photographs of the same scene. This technique, "bracketing", is especially useful when you are not sure which exposure will look best, as when photographing a sunset.



A. Normal exposure



B. Exposure adjustment set at +2.0 stops.



C. Normal exposure

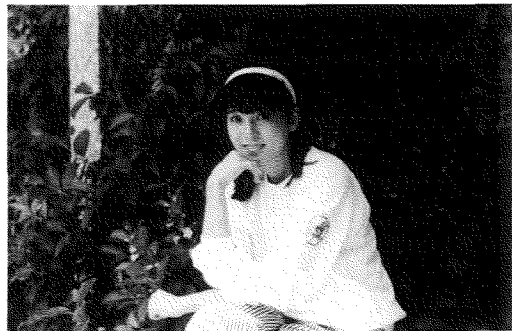

D. Exposure adjustment set at -2.0 stops.

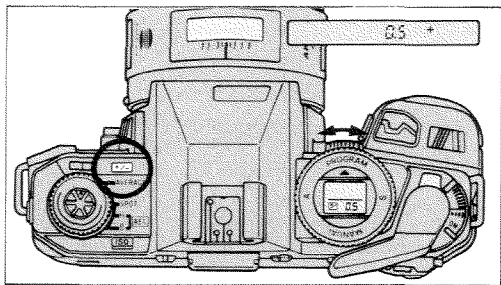

Exposure adjustment

Exposure adjustment can be used to deliberately increase or decrease exposure from the normal metered value. Adjustment range is from +4 to -4 stops in half-stop increments. **To set:**

1. Press and hold exposure adjustment key (marked +/-).
2. Move shutter up/down control until desired value appears in data panel. Set minus (-) numbers to decrease exposure and plus (+) numbers to increase exposure.

- Whenever exposure adjustment is set in P, A, or S mode, the "+" or "-" mark appears in data panel and adjusted value blinks in the viewfinder display.
- In M mode when exposure adjustment is set, no indication appears in data panel. Exposure deviation indicated in viewfinder includes the value set, which can be checked at any time by pressing the exposure adjustment key.

NOTE

- Reset exposure adjustment to "±0.0" after use.
- When using an R60 (red) filter, adjust exposure +1.0 stop.

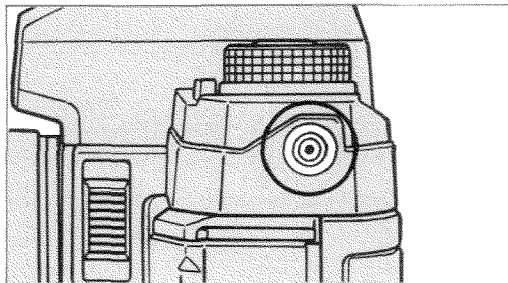
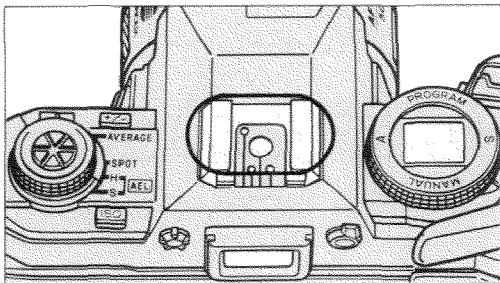

Accessory shoe

When using a Minolta MAXXUM Flash 2800AF or 4000AF unit, X-sync is automatic and Minolta Direct Autoflash Metering (TTL off-the-film) operates in all modes. X-sync in P mode is set at 1/250, 1/125, or 1/60 sec. depending on light level; in A mode, X-sync is set at 1/250 sec., and any aperture can be selected; in S mode, any speed 1/250 sec. or slower can be selected and aperture is set automatically to f/5.6; in M mode, any speed 1/250 sec. or slower and any aperture can be set.

Sync terminal

The sync terminal accepts PC-type sync cords from flash units that do not have a hot-shoe contact. Camera's X-sync speed must be set manually to any speed 1/250 sec. or slower. The camera's TTL flash metering does not operate with such units. To determine aperture setting for correct exposure, refer to flash owner's manual or use a flash meter.

Compared to portable electronic flashes, large studio-type units have capacitors which require more time to discharge at full power. Shutter speed should generally be set to 1/125 sec. or slower to assure full exposure when using these units.

SELF-TIMER OPERATION

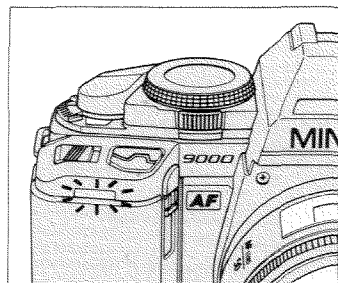
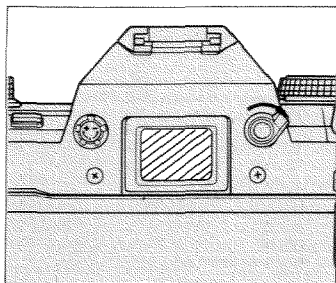
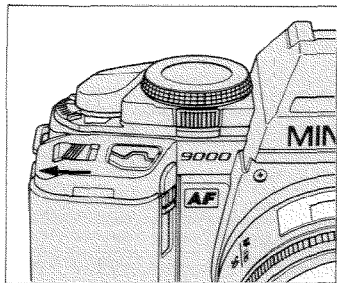

To use self-timer:

1. Slide self-timer switch away from operating button. Red mark will appear.
2. After focusing and metering for main subject, close eyepiece shutter.
3. Press operating button all the way down. During the ten-second countdown to shutter release, the self-timer LED blinks slowly for 8 sec., then rapidly for 1 sec., and remains on for the last second. For simultaneous audible beeping, set main switch to ON position.

To cancel operation:

If you have started the self-timer and wish to cancel it before the shutter releases, slide self-timer switch toward operating button.

NOTE

After using self-timer, be sure to turn it off by sliding self-timer switch towards operating button.

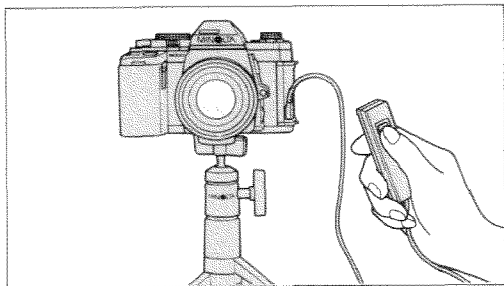

Tripod mounting

For maximum sharpness when exposure times are too long for hand-held photos, mount camera on a tripod using the socket on camera bottom. The optional Remote Cord RC-1000L or RC-1000S can be used to release the shutter without shaking camera.

NOTE

- Do not overtighten tripod screw when attaching the camera to tripod.
- Mounting screw should not be longer than 5.4mm (1/4 in.).

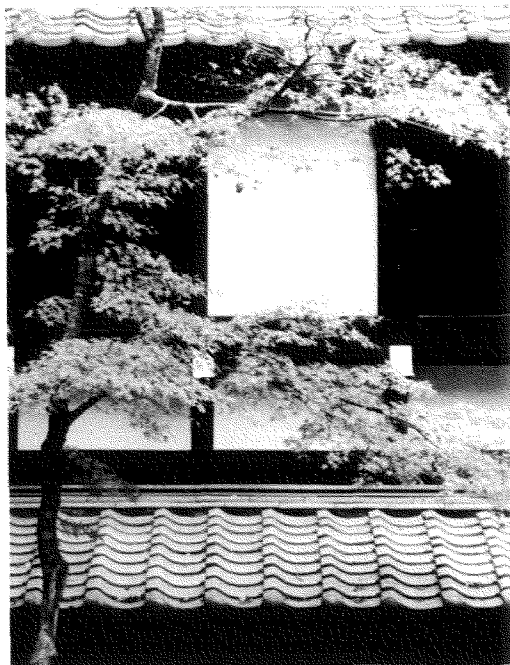

MULTIPLE EXPOSURES

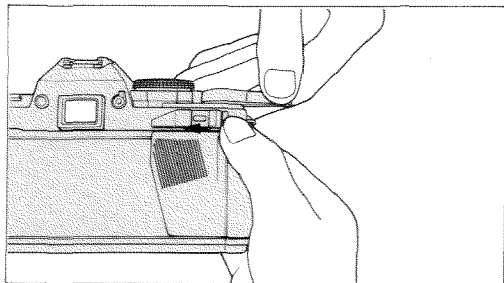

The MAXXUM 9000's multiple-exposure button enables cocking the shutter without advancing the film. When multiple exposures are made, the frame number does not change until film is actually advanced. To use:

1. Make the first exposure in the usual way.
2. While pressing multiple-exposure button all the way in, operate film-advance lever to cock shutter for the next exposure.
3. Repeat steps 1 and 2 to make additional exposures. After making the final exposure, release multiple-exposure button and operate film-advance lever. This will advance film to the next frame.

Determining exposure

The following suggestions can serve as basic starting points for determining correct exposure. However, subject matter, lighting conditions and your own intentions will all determine the final results.

When making two exposures of evenly illuminated subjects that fill most of the frame, set exposure adjustment to -1.0 . This will decrease exposure for each shot by one half and the cumulative exposure should be correct. For four exposures, set adjustment to -2.0 , and so on.

For multiple exposures of subjects against a dark background which do not overlap each other, exposure adjustment is not usually required.

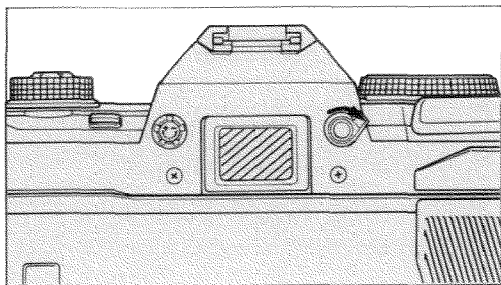

Eyepiece shutter

The MAXXUM 9000's eyepiece shutter should be closed whenever you are taking photographs with the eyepiece not shielded by your head, as in remote-control photography, self-timer operation, or during long exposures. This will prevent stray light from entering through the eyepiece and affecting the exposure.

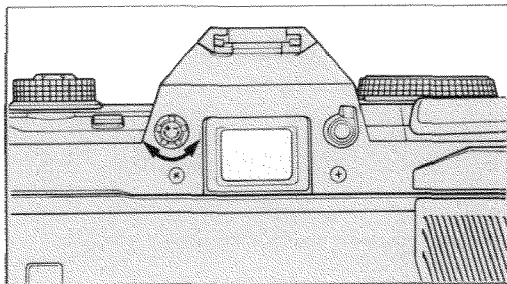

Eyepiece adjustment dial

This control enables near- or farsighted users to make dioptic adjustments to the eyepiece. Dioptic adjustment range is from -3 to $+1$ diopters.

To adjust: While looking through viewfinder, turn dial until focus frame appears sharpest. If additional correction is needed, a Minolta Eyepiece Corrector 1000 (p. 66) can be attached to the camera's eyepiece.

OTHER FOCUSING METHODS

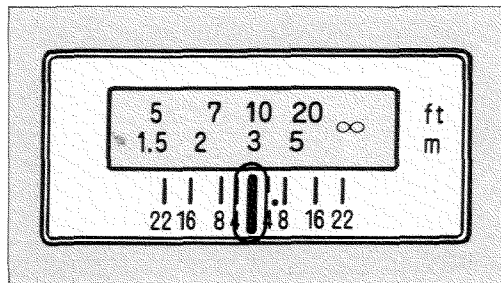

Distance scale

You may find in the following situations that it is easier to set focus manually for a specific distance:

- When making long exposures where it is too dark to focus visually.
- When you want to prefocus the lens at a certain distance and release the shutter as the subject reaches that spot.

To use scale: With focus mode set to M, estimate the distance to your subject, and turn focusing ring to align corresponding figure on distance scale with index line.

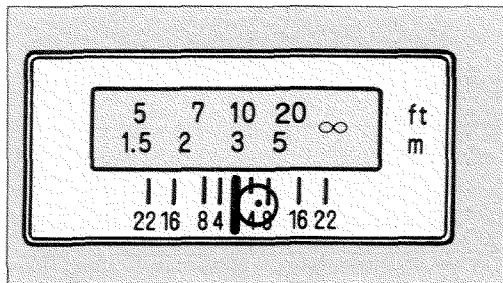

Infrared index

For proper focus when using infrared films, focus subject as usual and attach a filter, if desired. With focus mode switch at M, turn focusing ring until distance shown opposite the distance index aligns with the small red dot.

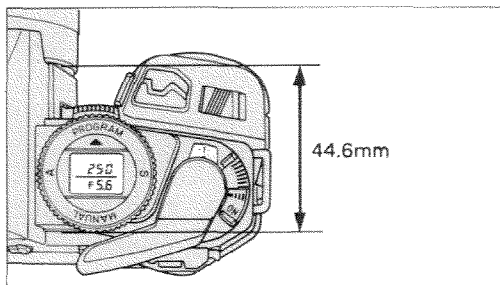

Film-to-lens-mount distance

This value is used when determining total film-to-subject distance, as when taking photographs at high magnifications. The distance between the film plane at the rear of the camera and the front surface of the lens mount is 44.6mm.

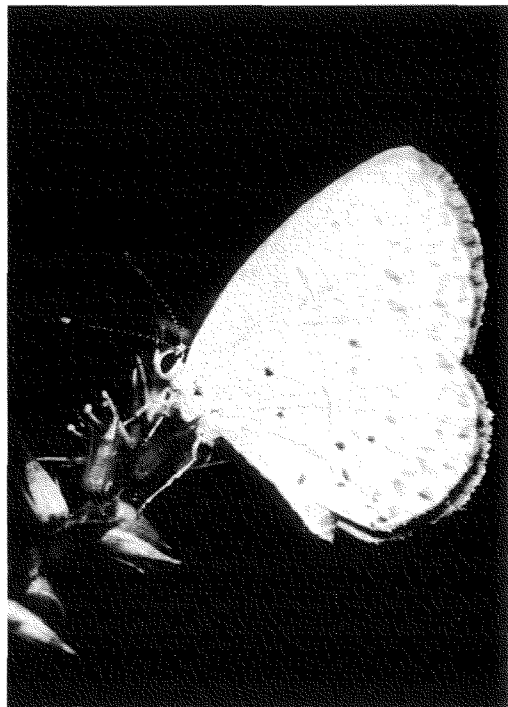

ACCESSORIES

MAXXUM Flash 1800AF: This ultra-compact unit is extremely easy to use; just switch it on and you are ready to shoot. It accepts a 6v lithium battery for shortest recycling, and AAA-size alkaline batteries can also be used. Guide Number is 18 in meters (59 in feet) with 35mm coverage.

MAXXUM Flash 2800AF: This intermediate unit provides increased flash power and has a Guide Number of 28 in meters (92 in feet) with 35mm coverage. Other features include high/low power settings and sufficient-exposure confirmation.

MAXXUM Flash 4000AF: This powerful unit has a Guide Number of 40 in meters (131 in feet) with 50mm coverage. An auto-zoom/bounce head enables efficient lighting control. The LCD panel shows power level, flash coverage, and flash ranges.



Macro Flash 1200AF Set

The Macro Flash 1200AF Set is specially designed for close-up and macro photography. Guide Number is 12 in meters (40 in feet). It attaches to most Minolta AF lenses and has four built-in lamps for easy focusing. Four flashtubes are set at right angles for complete lighting control. TTL off-the-film metering ensures proper exposure.

Guide numbers are based on ISO 100

Control Grip CG-1000 Set

The Control Grip CG-1000 attaches cordlessly to the MAXXUM 9000 and accepts either the MAXXUM Flash 4000AF or 2800AF. Its battery pack holds six AA-size batteries and delivers the additional power needed to reduce recycling time for sequential shooting. When two MAXXUM Flash or other compatible units are used, lighting-ratio control is automatic. Included in the CG-1000 set are an AF Illuminator AI-1000 and 16.5 ft. (5m) Extension Cable EC-1000.



Motor Drive MD-90

The Motor Drive MD-90 has professional features including 5 frames-per-second film advance, single-frame advance, or focus-priority shutter release with continuous film advance. The MD-90 is powered by either of two battery packs (sold separately): the Battery Pack BP-90M uses 12 AA-size batteries; the Ni-Cd Battery Pack NP-90M has rechargeable nickel-cadmium batteries and comes with the Ni-Cd Charger NC-90M for quick recharging.

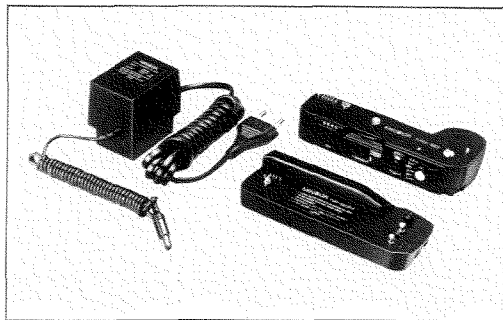

Auto Winder AW-90

The Auto Winder AW-90 is a more compact film winder for the Maxxum 9000. The AW-90 automatically advances film with either single-frame or continuous advance at up to two frames per second. The focus-priority setting can be selected assure that the subject is in focus before the shutter is released. The AW-90 uses 4 AA-size alkaline or rechargeable nickel-cadmium batteries.

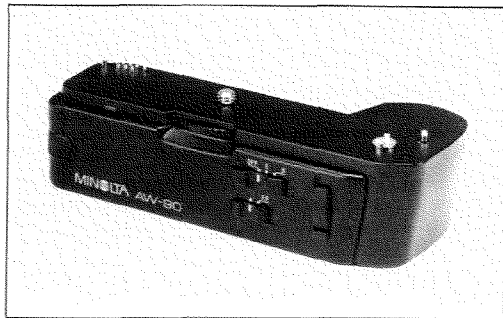

Program Back 90 enables imprinting of time (with day), year/month/day in any of three orders, and consecutive or fixed numbers. It also features an intervalometer function and can be set to make timed long exposures.

Program Back Super 90 features 7 exposure modes, automatic bracketing of up to 9 frames, a fully programmable intervalometer, data imprinting of the exposure settings, date, time, or consecutive/fixed numbers along the edge of the frame, and more.

100-Exposure Back EB-90 has a drop-in film magazine that holds 100 exposures of 35mm film. In addition, the EB-90 has all of the functions of the Program Back Super 90. The Film Loader FL-90 is used to load film into the film cartridges.



MAXXUM AF Lenses

A wide range of MAXXUM AF lenses is available for your MAXXUM 9000. These can be purchased separately from your photo dealer.

The MAXXUM AF lens system now features focal lengths from 16mm fisheye to 600mm apochromat telephoto. Included are nine macro/zooms covering focal lengths from 24mm to 300mm. Among these outstanding zoom lenses are the ultra-compact 35-70mm and 100-200mm zooms, which enable photographing landscapes or portraits with equal ease.

All MAXXUM AF lenses attach to the camera in the same way as explained earlier in this manual. When using program mode, the camera instantly selects one of three exposure programs based on the lens focal length in use. This is called as Auto Multi-Program Selection (AMPS).

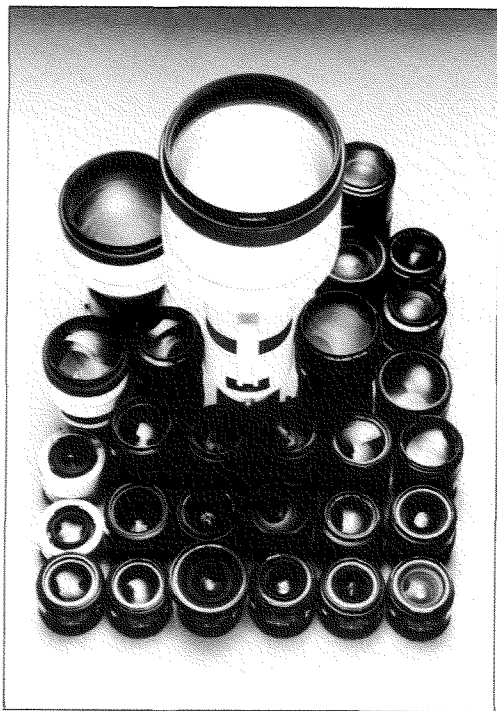

User-changeable Focusing Screens

Besides the MAXXUM 9000's standard focusing screen, four additional Acute-Matte screens are available. Tweezers are supplied with each screen, enabling quick, simple replacement by users.

Focusing Screen 90

Type G: Standard screen, focus frame and spot-metering circle centered on matte field; for general photography

Type L: Grid, focus frame, and spot-metering circle on matte field; for general and architectural photography

Type S: Vertical and horizontal scales, focus frame, and spot-metering circle on matte field; for macro-, micro-, and astrophotography

Type C: Focus frame and spot-metering circle on clear field

Focusing Screen 70

Type PM: Split-image/microprism/matte-field; autofocus zone along split-image, spot-metering area same diameter as microprism circle

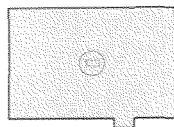

Type G

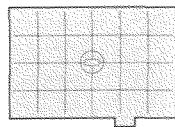

Type L

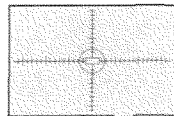

Type S



Type C

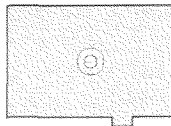

Type PM

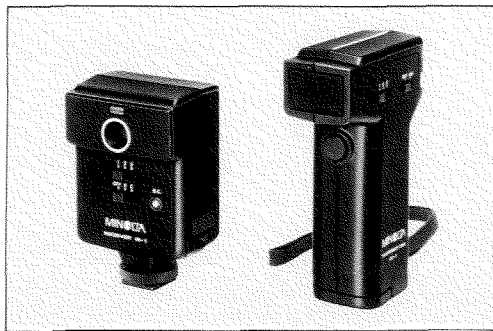

Wireless Controller IR-1N Set

The Wireless Controller IR-1N Set permits cordless, remote-control photography from up to approx. 200 ft. (60 meters) away. For maximum versatility, the Motor Drive MD-90 can be attached to the camera for shooting remote-controlled sequences. Separate receivers can be used for controlling up to three cameras.

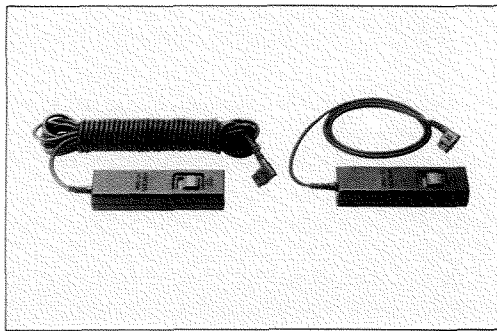

Remote Cord RC-1000L and RC-1000S

A remote cord should be used for long exposures (at "bulb" setting) or anytime you want to release the shutter without shaking the camera. Autofocusing and metering are both activated by partially pressing the release button. Pressing and sliding the release button locks the shutter open for long exposures.

RC-1000L is 16.5 ft. (5m) long; RC-1000S is approx. 20 in. (50cm) long.

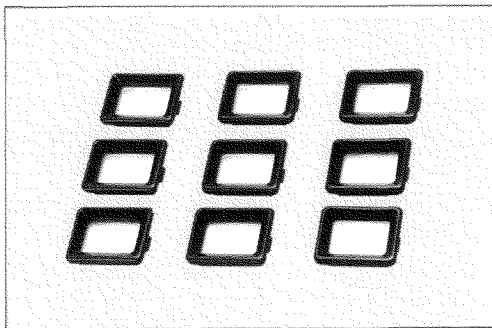

Eyepiece Corrector 1000

In addition to the MAXXUM 9000's built-in eyepiece adjustment, nine eyepiece correction lenses are also available for further adjustment of the eyepiece. These can be purchased separately and range from -4 to $+3$ diopters. Correctors snap into the camera's eyepiece frame.



Minolta Polarizing (Circular) Filter

To reduce or eliminate reflections from glass, water, or other non-metallic surfaces, Minolta's Polarizing (Circular) Filter should be used. If a regular polarizing filter is used, metering may not be accurate. (Light from regular polarizing filters is not fully transmitted by the MAXXUM 9000's semi-silvered main mirror.)

Filters

Autofocusing can be used with these Minolta filters:

L37 (UV), Y52 (yellow), G0 (green), O56 (orange), R60 (red), 1B (SKYLIGHT), A12 (85), B12 (80B), ND4X, Minolta Portrayer, and Polaring (Circular).

Other filters

When using filters other than those listed, autofocusing may not be accurate. In this case, focus manually with the filter attached, or autofocus and then attach filter.

Other Minolta system accessories

The following Minolta System accessories can be used with the Minolta 9000:

Angle Finder V_N, Magnifier V_N, Cable OC, Cable EX, Cable CD, Triple Connector TC-1000, Off-Camera Shoe, filters, Wireless Controller IR-1N Set with optional Connecting Cord IR-1 (C).

Minolta Autoflash units

All Minolta Auto Electroflash units can be used on the MAXXUM 9000; however, autofocusing and certain other features will not operate.

360PX and 132PX: FDC (flash distance check) signal does not function; all other functions are the same.

280PX: FDC signal does not function; "Lo" power setting cannot be used.

Macro 80PX: FDC signal does not function; illumination lamps go out when operating button is touched.

X-series units: TTL metering and FDC signal do not function.

IMPORTANT NOTICE

The MAXXUM System is designed and produced to offer innovative functions and performance through the combination of MAXXUM camera bodies, MAXXUM AF lenses, MAXXUM flash units and other accessories distributed by Minolta.

We thus caution users that the attachment or use of incompatible lenses, flashes and accessories may result in unsatisfactory performance or damage to the MAXXUM camera or its system accessories. Any such damage or failure of performance would not qualify as a defect in workmanship or materials covered by the Minolta product warranty. If you have any questions as to whether a particular lens, flash or accessory is compatible with the MAXXUM camera, we urge you to contact Minolta.

For optimum performance throughout the life of the MAXXUM camera and its accessories and to obtain the benefits of future MAXXUM system products, we recommend use only of lenses, flashes and other accessories manufactured by Minolta for the MAXXUM camera.

TECHNICAL DETAILS

Type: 35mm single-lens reflex camera with autofocus and multi-mode exposure control

Film format: 24 x 36mm

Lens mount: Minolta "A"-type bayonet, self-lubricating stainless steel

Autofocus system: Minolta TTL phase-detection type; working range: EV 2 to 19 at ISO 100; LED focus signals in viewfinder for both manual and automatic focusing

Shutter: Electronically controlled vertical-traverse focal-plane type

Shutter-speed range: In P and A modes: stepless 1/4000 to 30 sec.; in M and S modes: 1/4000 to 30 sec. in full-stop settings; "bulb" operates in M mode

Metering systems: TTL center-weighted averaging by compound silicon photocell at bottom of mirror box, or spot metering for midtone, highlight, or shadow using center portion of same SPC; spot-measurement area: 5.5mm circle in center of focusing screen, approx. 2.7% of film frame; center-weighted averaging range: EV 1 to 20

with ISO 100 and 50mm f/1.4 lens (e.g. 1 sec. at f/1.4 to 1/4000 sec. at f/16)

Film speed settings: ISO 6 to 6400 in third-stop increments; automatic film speed setting for DX-coded films can also be set manually; manual setting for non-DX films also possible

Exposure modes: Program AE with automatic multi-program selection of wide, standard, or tele program and program-shift capability; aperture-priority AE; shutter-priority AE; metered-manual exposure

Flash exposure modes: Direct (TTL) autoflash metering by same SPC; in all modes for ISO speeds 12-1000; program AE: automatic setting of X-sync to 1/250 sec. (above EV 13 at ISO 100), 1/125 (EV 12-13), or 1/60 (below EV 12); aperture-priority AE: X-sync set to 1/250 sec.; shutter-priority AE and metered manual: 1/250 or slower speeds usable, speed automatically reset to 1/250 sec. for manually set speeds above 1/250 sec.

AE lock: Works in P, A, and S modes; used in all exposure modes for highlight- and

shadow-based spot metering; used for slow-shutter sync with dedicated flash

Exposure adjustment: -4 to +4 EV in half-stop settings

Viewfinder: Eye-level fixed pentaprism type with built-in eyepiece correction adjustable from -3 to +1 diopters; field of view: 94% of film-frame area; magnification: 0.81X with 50mm lens at infinity

Data displays:

Top panel: LCDs indicate shutter speed, aperture, film speed, exposure adjustment, "bulb" elapsed time,

Viewfinder: LCDs indicate exposure mode, metering mode, shutter speed, aperture, film speed, exposure adjustment, and exposure deviation in metered-manual mode.

Operating button: Touch Switch activates metering and continuous autofocus; meter stays on for 10 sec. after finger is lifted from button; pressing halfway holds focus; pressing all the way releases shutter

Film transport: Manual film advance: Film-advance lever has 30° offset angle with

128° movement in single or multiple strokes

Film rewind: Manual by rewind crank

Frame counter: Additive type; camera set to 1/4000 sec. and lens' minimum aperture until "1" appears in frame counter

Mirror: Semi-silvered swing-back type; secondary mirror for metering and autofocus

Audible signals: With main switch at ON (I) position, camera "beeps" when using focus hold, focusing manually, and during self-timer operation

Self-timer: Electronic with 10-second delay; operation indicated by blinking LED and audible "beeps"; cancellable

Power: Two AA-size 1.5v alkaline-manganese, carbon-zinc, or 1.2v rechargeable nickel-cadmium batteries

Preview switch: Used for checking depth of field; operates in all four exposure modes; pressing partway down stops down and locks lens diaphragm at aperture setting shown in data panel and finder; when used, "F" blinks in data panel.

Multiple-exposure button: Enables making more than one exposure on a single frame; when pushed all the way in, shutter can be recocked without advancing film; frame counter does not advance during use.

Others: Sync terminal, eyepiece shutter, remote-control terminal, film window, user-changeable focusing screen

Dimensions: 2-7/8 x 3-5/8 x 5-1/2 in. (53 x 92 x 139mm)

Weight: 22-3/4 oz. (645g) without batteries and lens

Specifications subject to change without notice

CARE AND STORAGE

- Always keep your camera in its case with the lens capped when not in use, or with a body cap on when a lens is not attached.
- No part of the camera should be forced at any time.
- Never subject your camera to shock, high heat, high humidity, water, or harmful chemicals. Be particularly careful not to leave it in the glove compartment or other places in motor vehicles where it may be subjected to high temperatures.
- Never lubricate any part of the camera body or lens.
- Never touch the shutter curtains or the front inside parts of the body or clean them with compressed air. Doing so may impair their alignment and movement.
- External camera surfaces and lens barrel--but not glass surfaces--can be cleaned by wiping with a dry or silicone-treated cloth.
- Never touch lens or eyepiece surfaces with your fingers. Whisk away loose matter with a blower brush. To remove stubborn spots, use a sheet of photographic lens tissue. If neces-

sary, tissue may be moistened with one drop of lens-cleaning fluid. Never drop fluid directly on glass surfaces.

- It is recommended to have your camera cleaned once a year at an authorized Minolta service facility.

- When storing camera for more than two weeks, remove the batteries and keep it in a cool, dry place away from dust or chemicals, preferably in an airtight container with a drying agent such as silica gel.

- The operating range for the LCDs is from -20° to $+50^{\circ}\text{C}$ (15° to 120°F). At temperatures outside this range, response time and contrast will change, making displays difficult to read. At very high temperatures, display may temporarily turn black. In either case, display should return to normal after a short period of time.

- The LCDs should last approximately ten years. When replacement is needed, contact your nearest authorized Minolta service facility.

Save camera box and packing material. When shipping your camera, carefully repack it in the box, insure adequately, and use a reliable delivery service.

Before shipping your camera for repairs, contact your nearest authorized Minolta service facility.

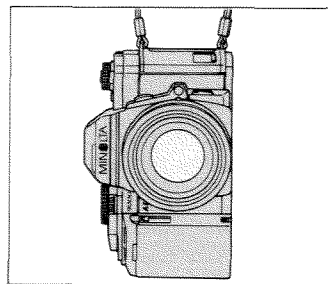
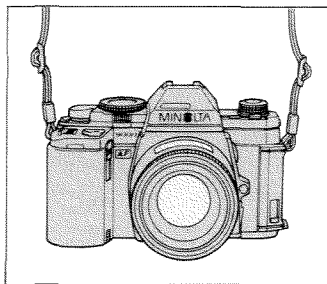
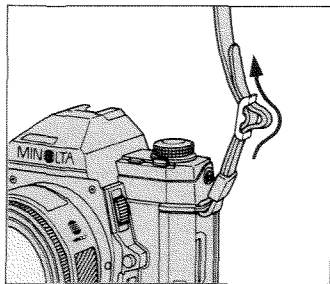

Attaching strap

A neckstrap is included with the MAXXUM 9000. It can be attached in either of two ways as shown above

Minolta Camera Co., Ltd.

Minolta Corporation

Head Office

Los Angeles Branch

Chicago Branch

Atlanta Branch

Minolta Canada Inc.

Head Office

Montreal Branch

Vancouver Branch

Minolta Camera Handelsgesellschaft m.b.H.

Minolta France S.A.

Minolta (UK) Limited

Minolta Austria Gesellschaft m.b.H.

Minolta Camera Benelux B.V.

Belgium Branch

Minolta (Schweiz) AG

Minolta Svenska AB

Minolta Hong Kong Limited

Minolta Singapore (Pte) Ltd.

30, 2-Chome, Azuchi-Machi, Higashi-Ku, Osaka 541, Japan

101 Williams Drive, Ramsey, New Jersey 07446, U.S.A.

3105 Lomita Boulevard, Torrance, CA 90505, U.S.A.

3000 Tollview Drive, Rolling Meadows, IL 60008, U.S.A.

5904 Peachtree Corners East, Norcross, GA 30071, U.S.A.

369 Britannia Road East, Mississauga, Ontario L4Z 2H5, Canada

376 rue McArthur, St. Laurent, Quebec H4T 1X8, Canada

105-3830 Jacombs Road, Richmond, B.C. V6V 1Y6, Canada

Kurt-Fischer-Strasse 50, D-2070 Ahrensburg, West Germany

357 bis, rue d'Estienne d'Orves, 92700 Colombes, France

1-3 Tanners Drive, Blakelands North, Milton Keynes, MK14 5BU, England

Amalienstrasse 59-61, 1131 Wien, Austria

Zonnebaan 39, 3606 CH Maarssenbroek, P.B. 264, 3600 AG Maarssen, The Netherlands

Stenen Brug 115 – 117, 2200 Antwerpen, Belgium

Riedhof V, Riedstrasse 6, 8953 Dietikon-Zurich, Switzerland

Brännkyrkagatan 64, Box 17074, S-10462 Stockholm 17, Sweden

Room 208, 2/F, Eastern Center, 1065 King's Road, Hong Kong

10, Teban Gardens Crescent, Singapore 2260

Eyepiece adjustment dial

Film speed key

DX contacts

Eyepiece shutter lever

Film advance lever

AE lock

Multiple-exposure button

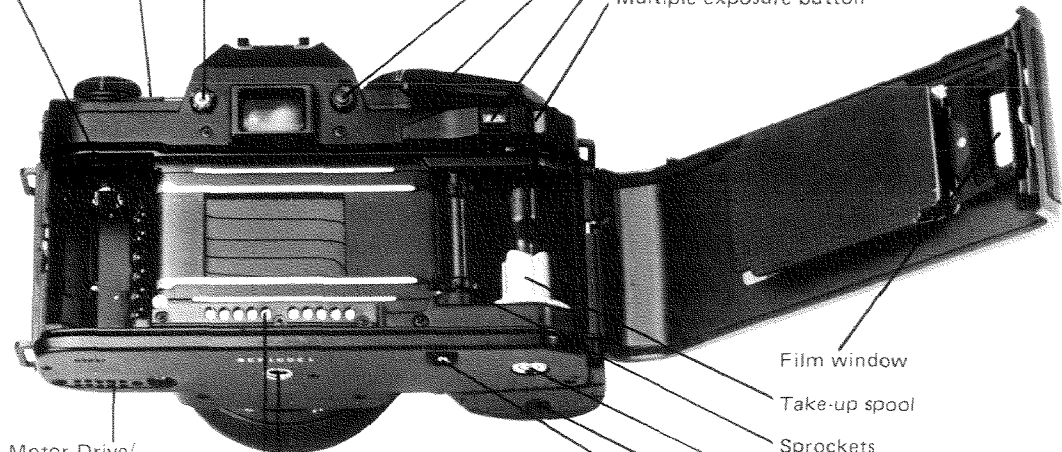

Film window

Take-up spool

Sprockets

Motor Drive couplers

Battery holder

Rewind release

Motor Drive/
Control Grip contacts

Accessory-back
contacts

Tripod socket

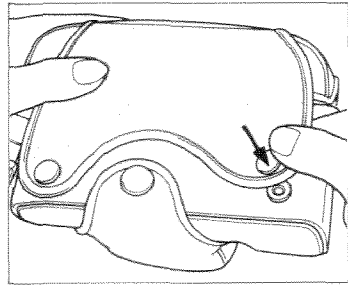
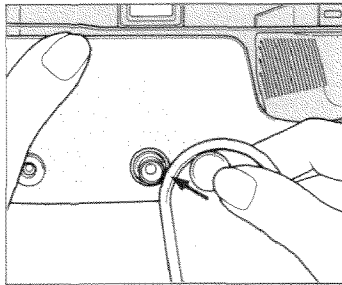
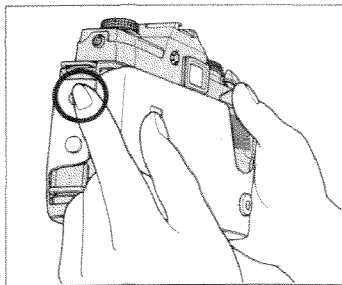

Putting camera in case

Various camera cases are available as optional accessories to the MAXXUM 9000.

To attach:

1. Attach lens cap.

2. With zoom lenses, adjust zoom ring until lens barrel is at its shortest position.

3. Insert camera in case as shown above.

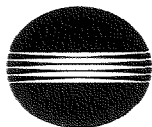

MINOLTA