

MINOLTA SR-T 101

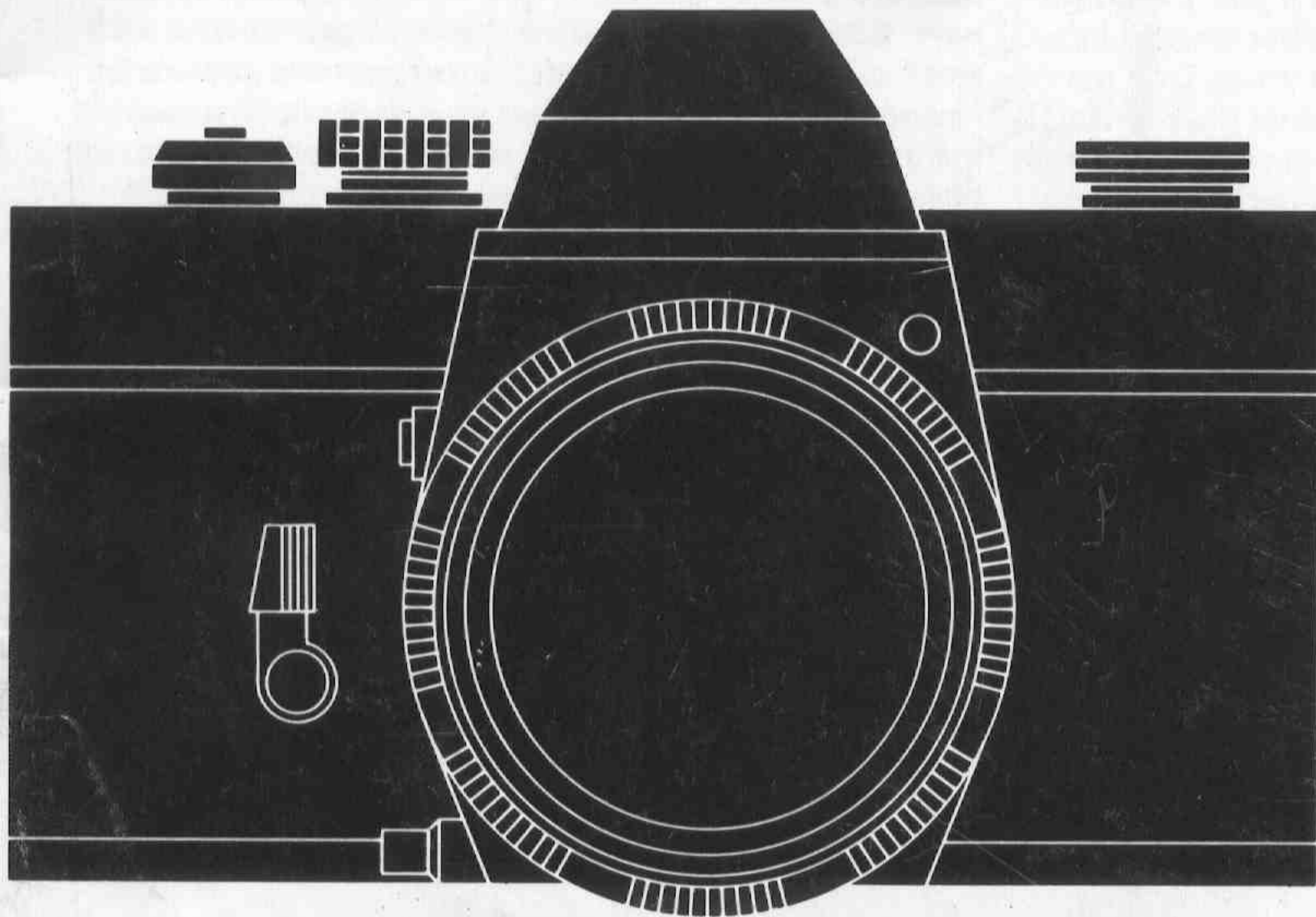

OWNER'S MANUAL

E

Since the inception of through-the-lens exposure measuring for single-lens-reflex cameras, several systems have been developed. Some "spot" read only a very small part of the total area. Other systems provide an "average" reading composed of independent measurements taken by two cells which is not accurate in high-contrast situations.

Only the Minolta SR-T 101 has an exclusive new type of circuit (CLC) to provide optimum reading of the entire picture area regardless of degree of contrast.

In addition to its more accurate exposure meter system, your Minolta SR-T 101 is designed to handle more easily, with greater speed, than other "through-the-lens metering" cameras.

The ability to compose, focus, set exposure and shutter speed without looking away from the finder makes the Minolta SR-T 101 particularly suitable for professional photography, when operating speed is often of vital importance. (All illustrations used in this booklet are with the F1.4 lens. There is, however, no fundamental difference in usage between the F1.4 and the F1.2 or F1.7 lens.)

CONTENTS

NAMES OF PARTS	2
MAJOR FEATURES	4
SPECIFICATIONS	5

PREPARATIONS BEFORE TAKING PICTURES

Inserting the mercury battery	7
Checking the battery power	9
Loading film	10
Setting the ASA number (film speed)	14
ASA/DIN converting scale	14

TAKING PICTURES

TTL with CLC: A new exposure measuring system	15
Setting the correct exposure	16
Shutter speed and aperture settings.....	18
Focusing the camera	20
Holding the camera	21

TAKING FLASH PICTURES

Attaching flash unit	23
Setting correct exposure	24

MORE ADVANCED GUIDES

Depth of field	
----------------	--

Lens aperture controls	
depth of field	25
Depth-of-field table of MC Rokkor 58mm F1.2 and F1.4 lens (in feet)	27
Depth-of-field table of MC Rokkor 58mm F1.2 and F1.4 lens (in meters)	28
Depth-of-field table of MC Rokkor 55mm F1.7 lens (in feet)	29
Depth-of-field table of MC Rokkor 55mm F1.7 lens (in meters)	30
Checking the effects of depth of field	31
Mirror lock-up control	32
Self-timer	33
Infrared index	34
Film plane index	34

UNLOADING EXPOSED FILM

CHANGING LENSES

USING INTERCHANGEABLE ROKKOR LENSES OTHER THAN MC LENSES

Auto Rokkor Lenses	39
Manual preset Rokkor Lenses	40

CARE AND STORAGE

NAMES OF PARTS

2

- Film Rewind Crank and Back Cover Release Knob
- Accessory Shoe
- Pentaprism
- Shutter and ASA Speed Dial
- Film Advance Lever
- Shutter Release Button
- Frame Counter
- Lens Release Button
- Meter Coupler
- Depth-of-Field Scale
- Mirror Lock-Up Button
- Diaphragm Ring
- Distance Scale
- Self-Timer Lever
- Focusing Ring
- Rokkor Lens
- Diaphragm Stop-Down Button

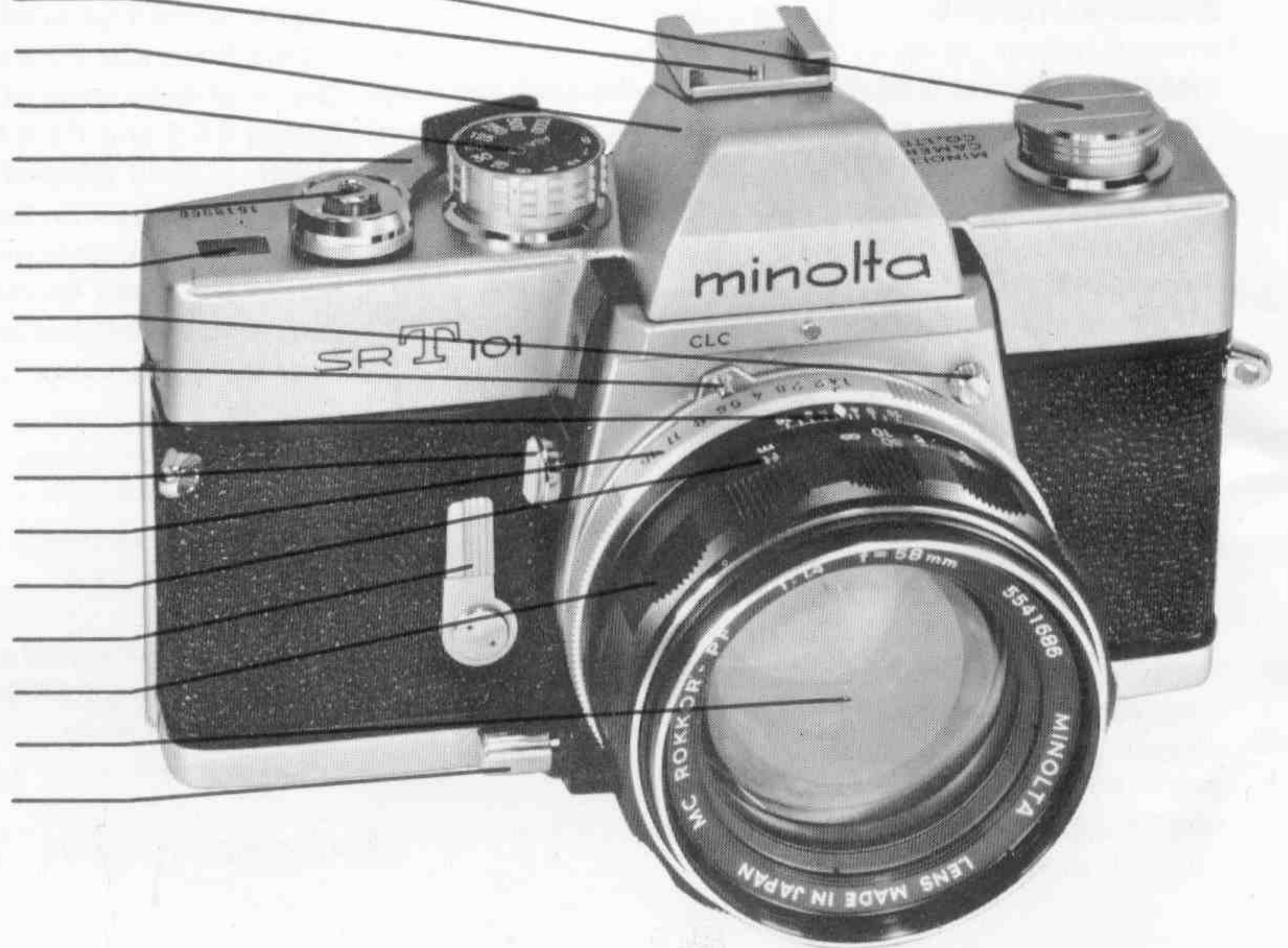

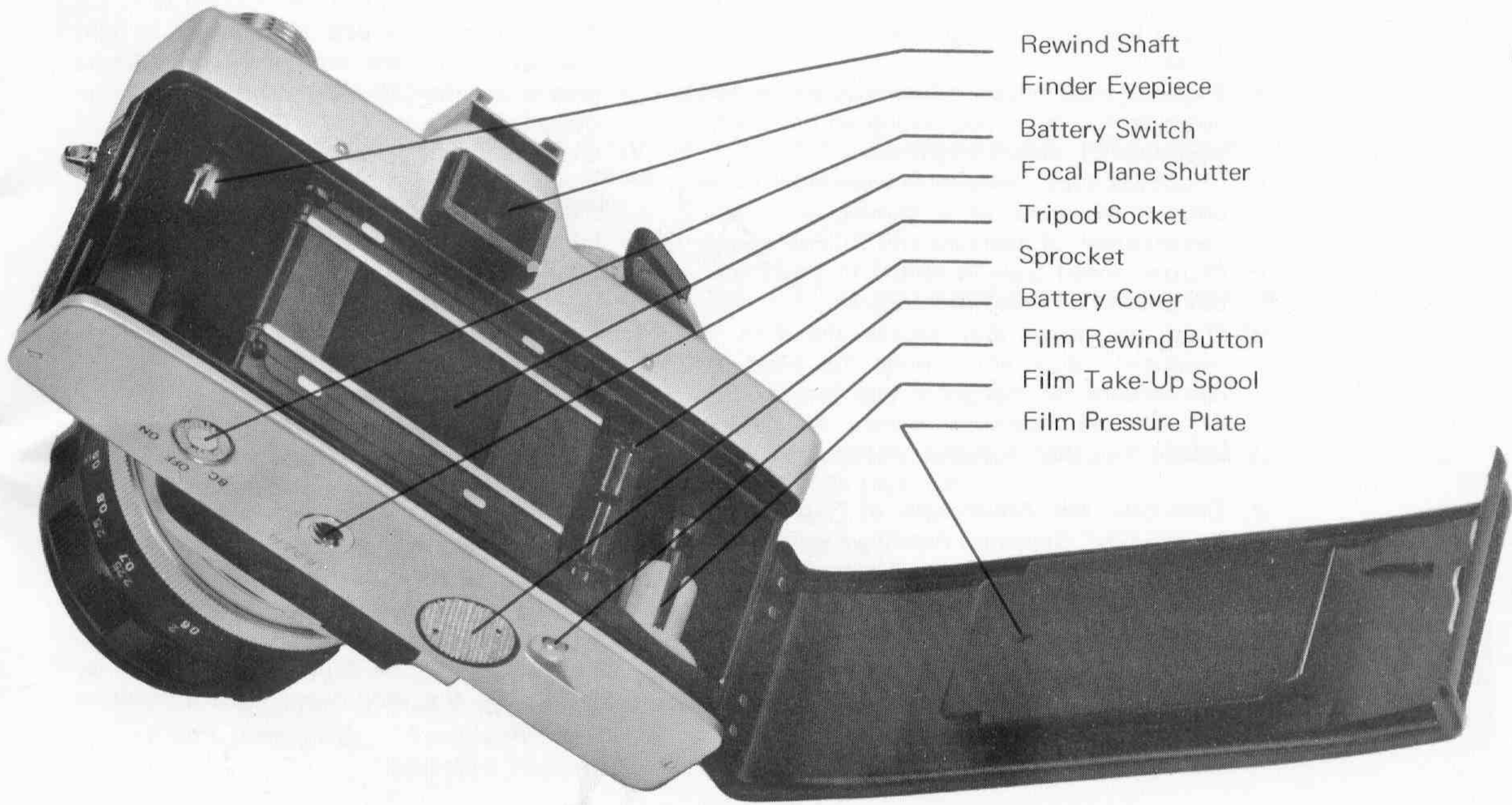

Rewind Shaft

Finder Eyepiece

Battery Switch

Focal Plane Shutter

Tripod Socket

Sprocket

Battery Cover

Film Rewind Button

Film Take-Up Spool

Film Pressure Plate

MAJOR FEATURES OF THE MINOLTA SR-T 101

4

1. Rapid-Reading Through-the-Lens Exposure System

- a) Exposure readings are taken with lens at full aperture for rapid composing and focusing regardless of subject brightness.
- b) "Follower-type" needles in viewfinder show correct exposure at a glance, with any combination of aperture and shutter speed.
- c) Shutter speed scale is visible in viewfinder but outside of "live" picture area.
- d) Only the light that strikes the film is measured, thus eliminating the need to compensate for changes in lens focal length or compute exposure factors for filters, bellows or other lens attachments.

2. Combines the Advantages of "Spot" and "Averaging" Exposure Reading Systems

- a) Exclusive "CLC" Metering System (Contrast Light Compensator) maintains extreme accuracy regardless of lighting situation, even with high-contrast subjects.

- b) Automatically corrects for changes in light intensity from one section of the picture area to another, thus providing an optimum overall reading.

- c) Oversize, instant return mirror prevents image cutoff and incorrect exposure readings no matter how long the focal length of lens.

- d) Unique positioning of CdS cells prevents incorrect readings due to light entering viewfinder.

3. World-Renowned Rokkor Lenses

Superior resolving power resulting from the combination of rare earths, patented Achromatic coating and computer design.

4. Complete System of Lenses and Accessories for Maximum Versatility

Almost all Rokkor lenses designed for use with the Minolta SR-1, SR-3 and SR-7 can be used with the Minolta SR-T 101 by means of the stop-down light measuring method.

SPECIFICATIONS OF THE MINOLTA SR-T 101

5

—35mm single-lens-reflex camera with through-the-lens exposure meter—

Standard lens MC Rokkor 58mm F/1.4 (F1.2 or 55mm F/1.7) equipped with meter coupler

Composition: 6 elements in 5 groups

Coating: Achromatic coating

Angle of view: 41° with 58mm lens (43° with 55mm lens)

Diaphragm: Fully automatic

Diaphragm scale: (1.2), 1.4, (1.7), 2, 2.8, 4, 5.6, 8, 11, 16 with equal-space and intermediate click F-stops

Filter mount: ϕ 55mm (ϕ 52mm), screw-in

Shade mount: ϕ 55mm (ϕ 52mm), screw-in

Lens mount: SR bayonet mount

Shutter Focal plane type

Speeds: B, 1, 1/2, 1/4, 1/8, 1/15, 1/30, 1/60, 1/125, 1/250, 1/500, and 1/1000 sec.

Selector dial: Single, non-spinning, equal-space, click stop dial

Sync. contact: FP (all speeds) and X (up to 1/60 sec.)

Self-timer: Time adjustable, 10 sec. maximum delay

Film advance Lever type, quick advance winding with shutter locking and double exposure prevention

Winding method: Single- or multiple-stroke, with 20° free clearance

Winding angle: 150°

Frame counter: Automatic resetting counter showing number of exposed frames

Film rewinding: Rapid rewinding with crank

Frame size: 36 x 24mm

Film: Standard 35mm film, 12, 20, or 36 exposures

Viewfinder Real-image type through fixed, eye-level pentaprism; exposure control needles (follower system), battery check mark, and shutter speed scale visible in finder

Focusing screen: Central microprism with fine ground glass collar and field lens

Image magnification: Life-size image viewing with 58mm lens at infinity

Exposure meter Through-the-lens metering system

Exposure meter: Contrast light compensator (CLC) with CdS meter, two cells on the pentaprism

Measurement: Measuring at full aperture coupled to shutter speed, aperture, and film speed setting

Control: Follower-needle system viewed in the finder

Working range: EV 3 to EV 17 with ASA 100 film

Diaphragm button: Depth-of-field preview button for MC Rokkor lenses; measuring (stop-down) button for other than MC Rokkor lenses

Film speed range: ASA 6 – 6400, DIN 9 – 39

ASA setting: On shutter speed dial; built-in ASA/DIN conversion scale on camera back

Battery: 1.35v mercury battery, Mallory PX-625 or equivalent

Switch: ON, OFF, and battery check switch on base of camera

Focusing Bright-screen with microprism and fine ground glass

Focusing distance: 60cm (2 ft.) to infinity

Focusing method: Direct helicoid focusing with infrared index

Mirror Oversize quick-return mirror with lock-up device

Others Built-in accessory shoe

Size and weight With F1.4 lens

Width 145mm (5¾"); Depth 89mm (3½"); Height 95mm (3¾"); 990g (35 oz)

PREPARATIONS BEFORE TAKING PICTURES

Inserting the mercury battery

1. The Minolta SR-T 101 uses a 1.35v, button-shape mercury battery for photographic applications (Mallory PX-625, PX-13, Eveready EXP-625, EPX-13 or equivalent).

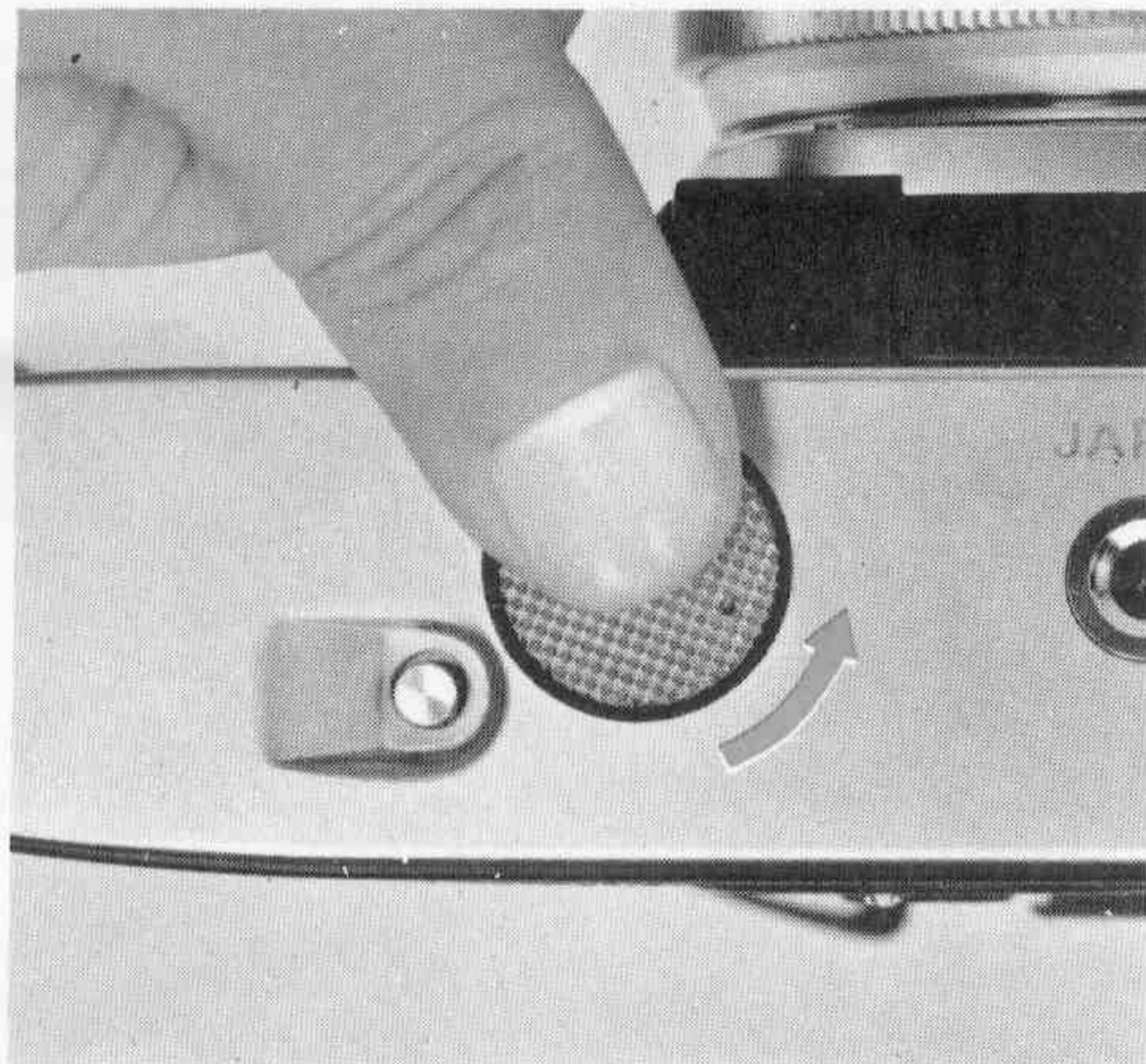

2. To install, remove the battery chamber cover with your thumb by turning it counterclockwise. Place the battery in the chamber with its plus side out and replace the cover.

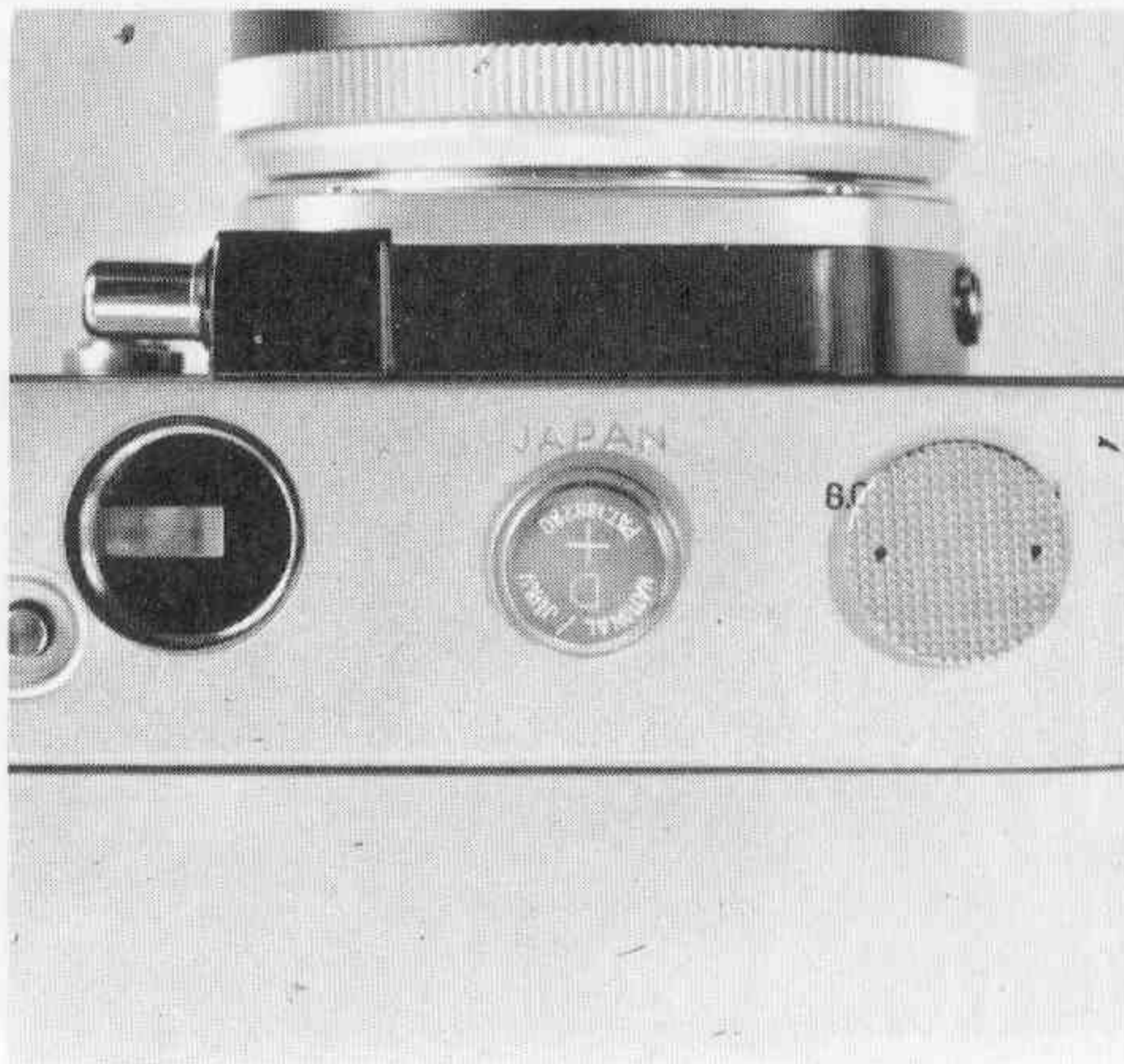



CAUTION:

- Do not touch the battery terminals with moist or dirty hands, as this can cause them to deteriorate and make the battery inoperative.
- Do not discard a mercury battery in a fire or break it up.
- When the camera is not being used, it is advisable to turn the battery switch on the base of the camera to the "OFF" position.
- If the camera is not to be used for over two weeks, remove the battery and store it in a dry, cool place.
- Before putting the battery back in the camera, clean both sides of the battery and the contact lead of the battery chamber with dry cloth.

Checking the battery power

The battery checker is designed to check the output of the mercury battery. By taking a few seconds to check battery output before starting each new roll of film, and particularly when using the camera after it has been stored for an extended period of time or a new battery has been inserted, you can avoid poor exposure due to insufficient electric power.

1. Turn the battery switch on the base of the camera to the "B.C." position.

2. If the indicator needle points to the battery check mark as shown in the picture, the battery can be regarded as functioning properly.

CAUTION:

- Do not leave switch setting at battery check position as the continuous high battery drain will cause the battery to go "dead" in a few hours.

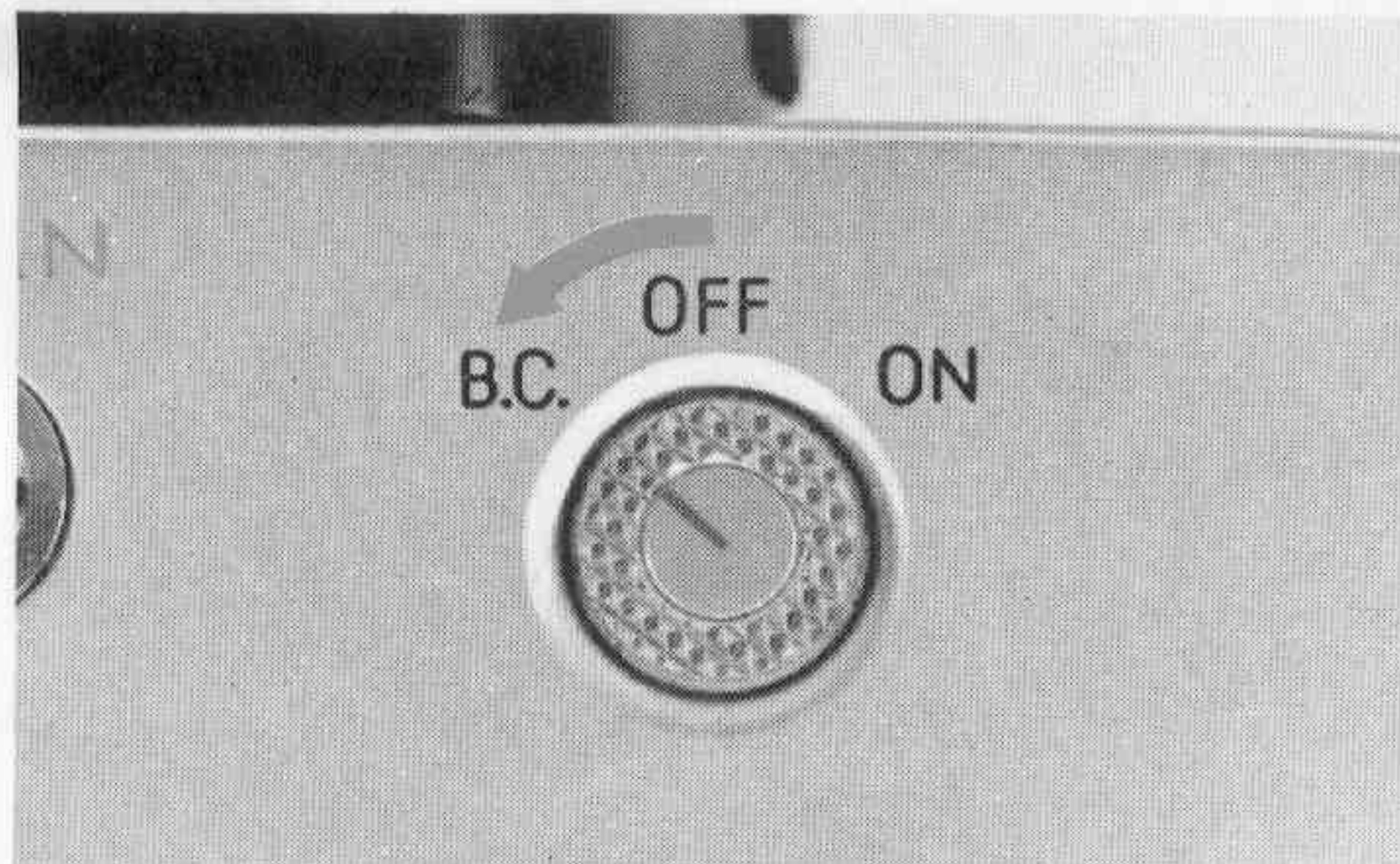

Loading film

1. Raise the back cover open release knob (which also incorporates the film rewind knob) until some resistance is felt. With a slight additional pull, the back cover will automatically "pop" open.

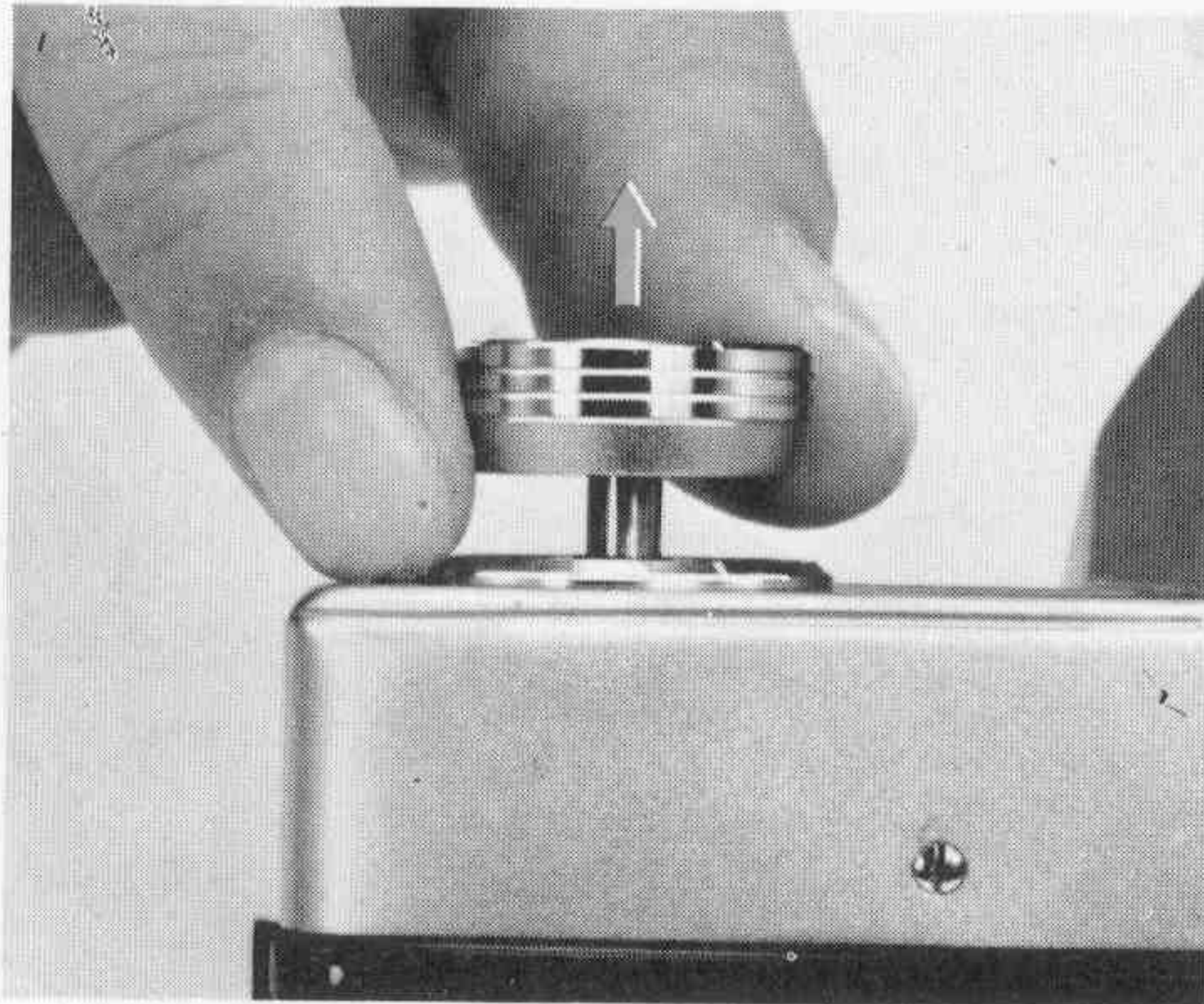

2. Insert the film leader into a slot in the film take-up spool as shown.

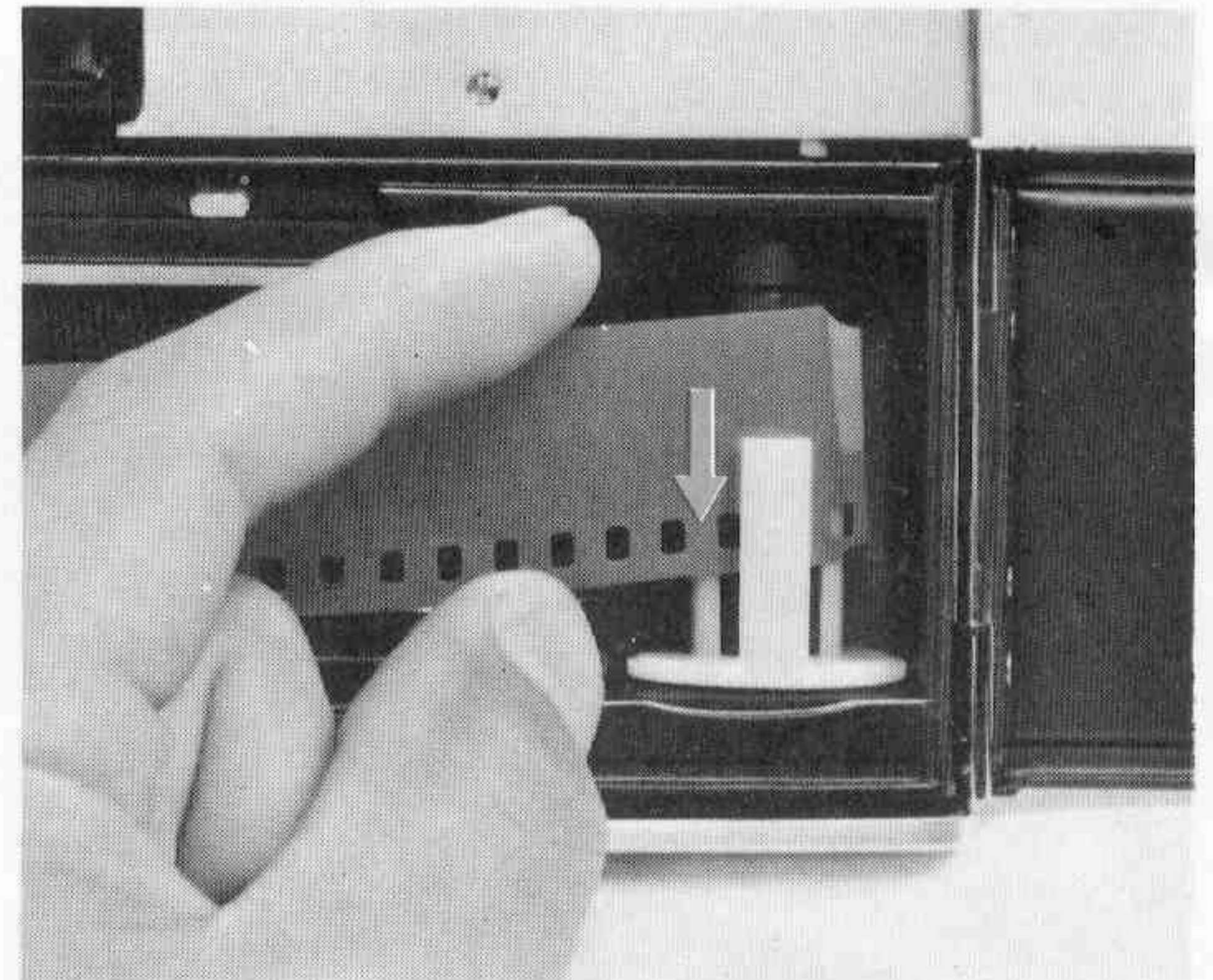

3. Place the film magazine into the film chamber and push the back cover release knob all the way down. (When inserting the film magazine, its projecting center drum must be placed in a downward position.)

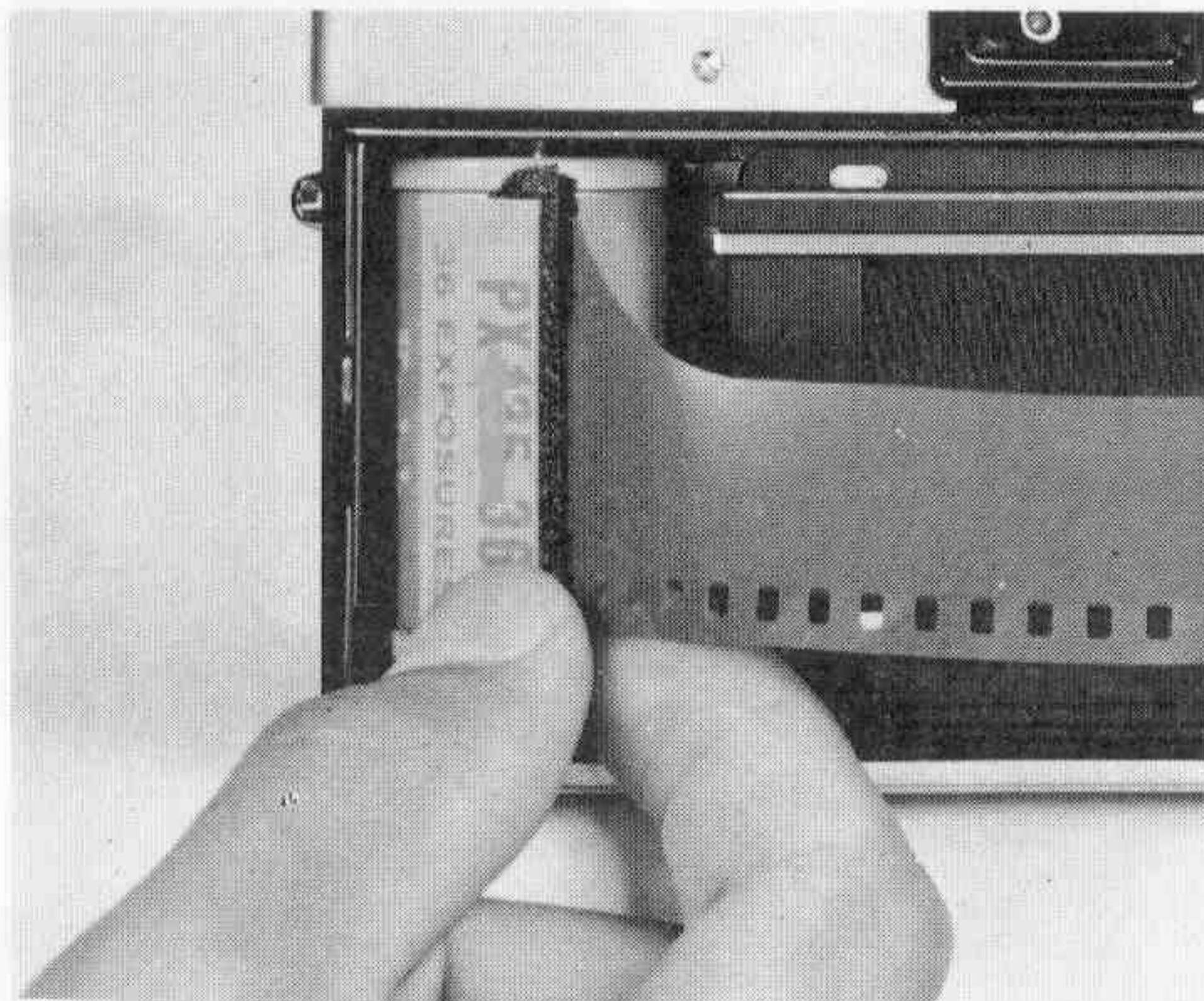

4. Operate the film advance lever in several "short" strokes until the film has begun to wind firmly around the take-up drum and both sides of the film perforations are securely engaged with the teeth of the sprocket gear. If the film advance lever locks during this procedure, press the shutter release button and then continue.

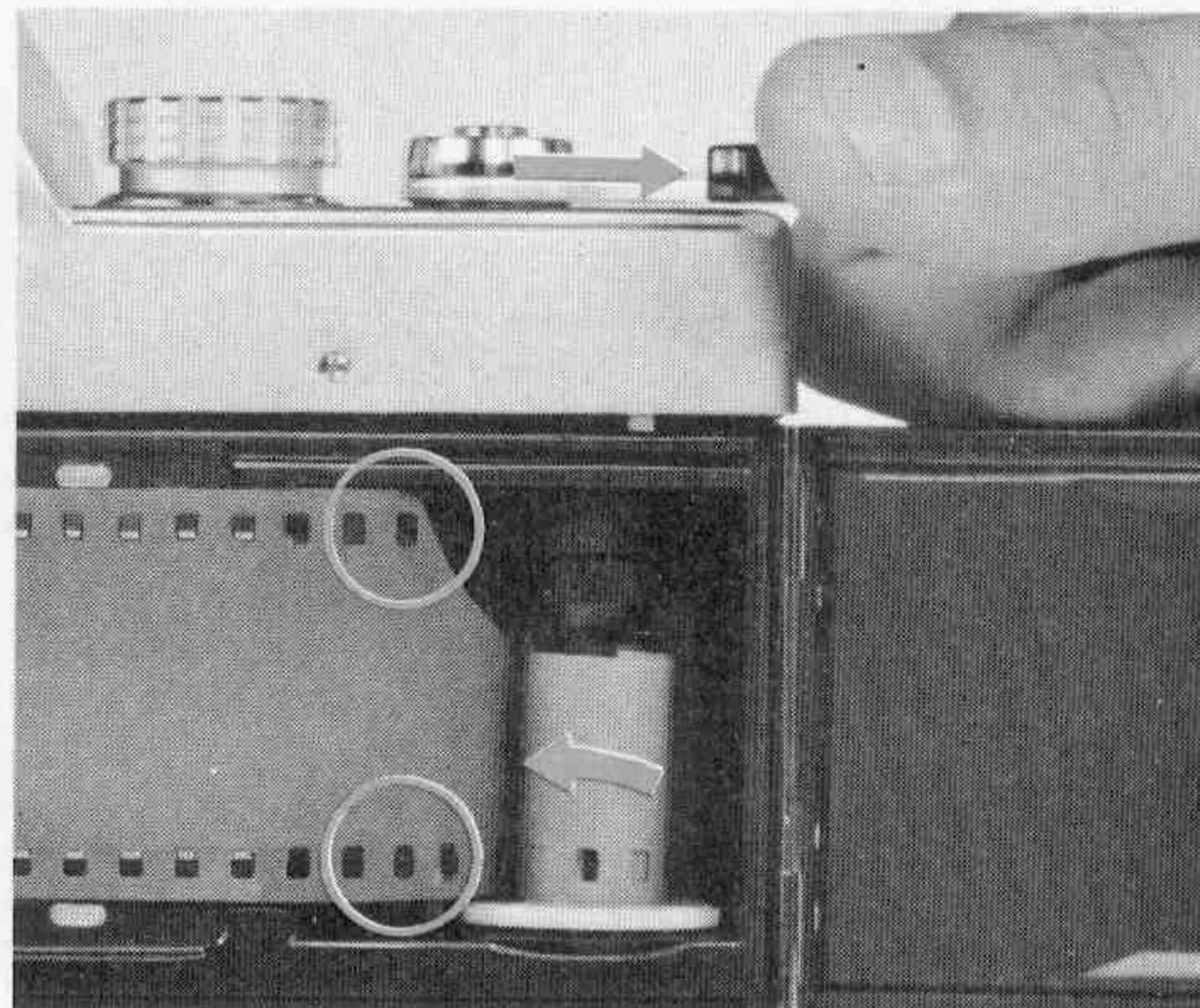

5. Close the camera back once you are certain that the film is winding securely on the take-up spool and engaged with on both sprockets.

Rotate the film rewind crank gently in the direction of the arrow to make sure that the film is flat against the pressure plate.

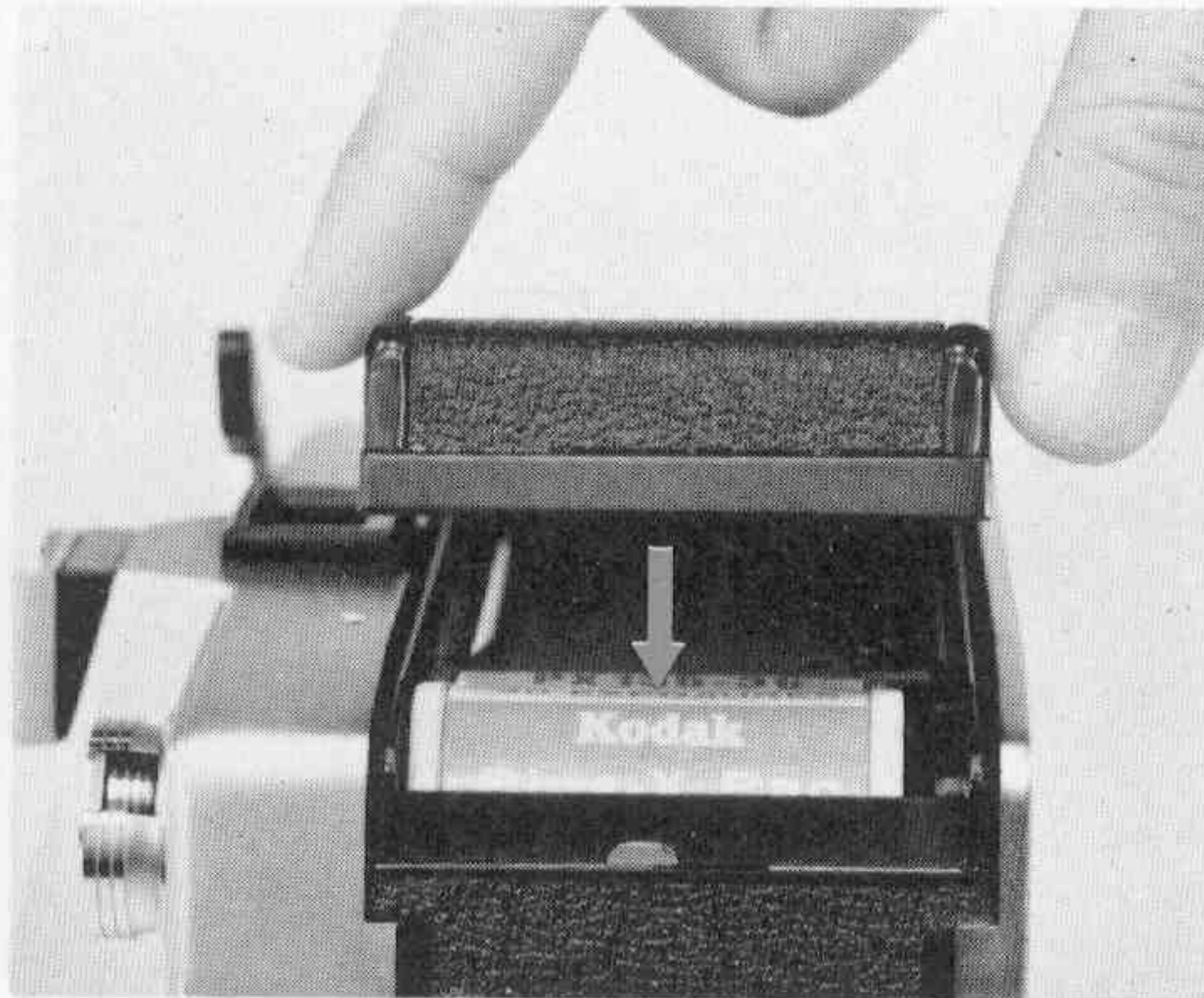

6. Advance the film and press the shutter release button. Repeat this action until the number "1" appears at the arrow mark in the frame counter window.

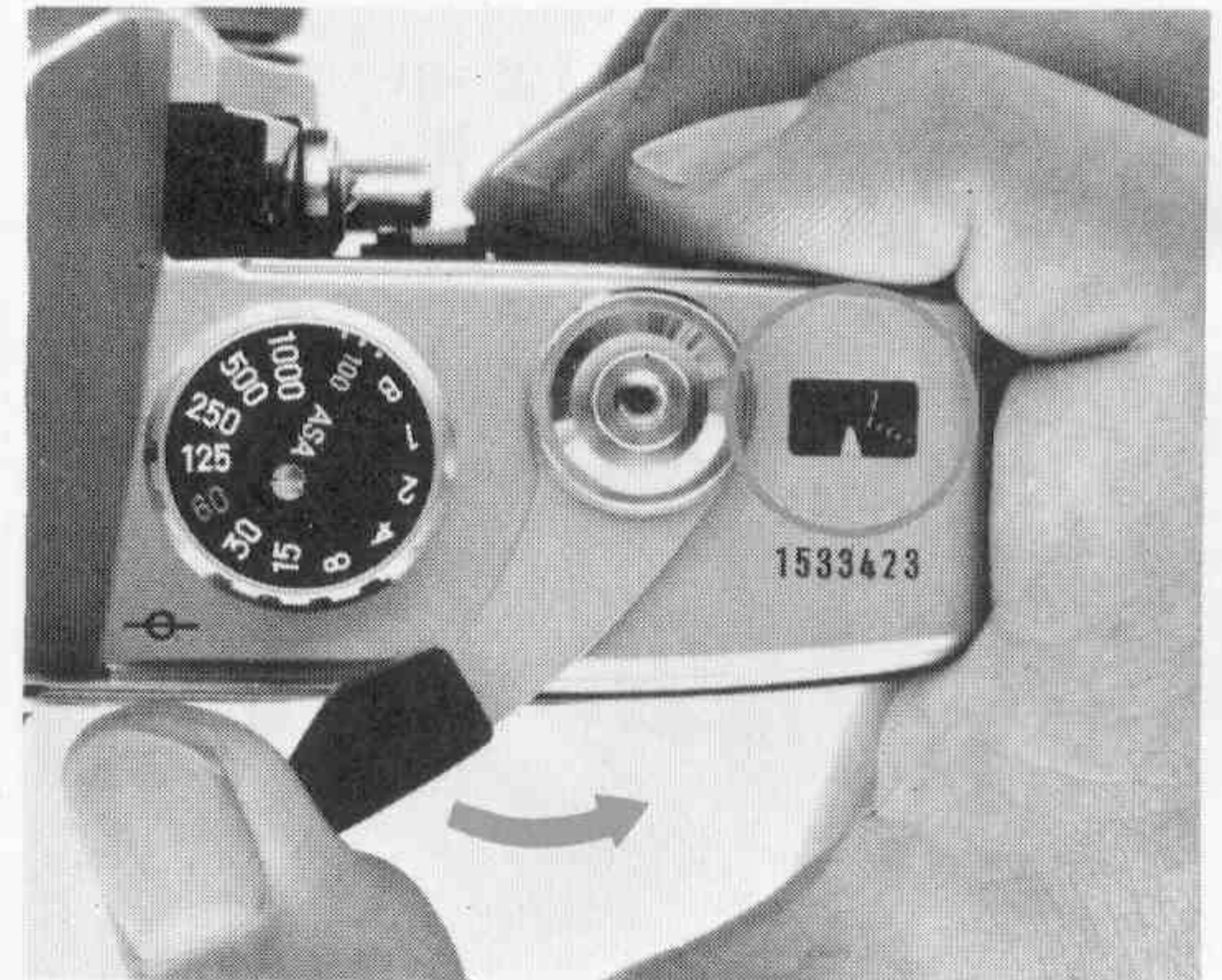

NOTE:

- The frame counter indicates the number of pictures taken from 1 to 36.
- The film advance lever has a total "throw" of 170° ; of this distance, the first 20° have no effect on the film but are intended to provide a "free play" range through which the lever may be "offset" from the body for rapid shooting.
- When the camera back is opened, the counter automatically resets itself to the start (S) position.

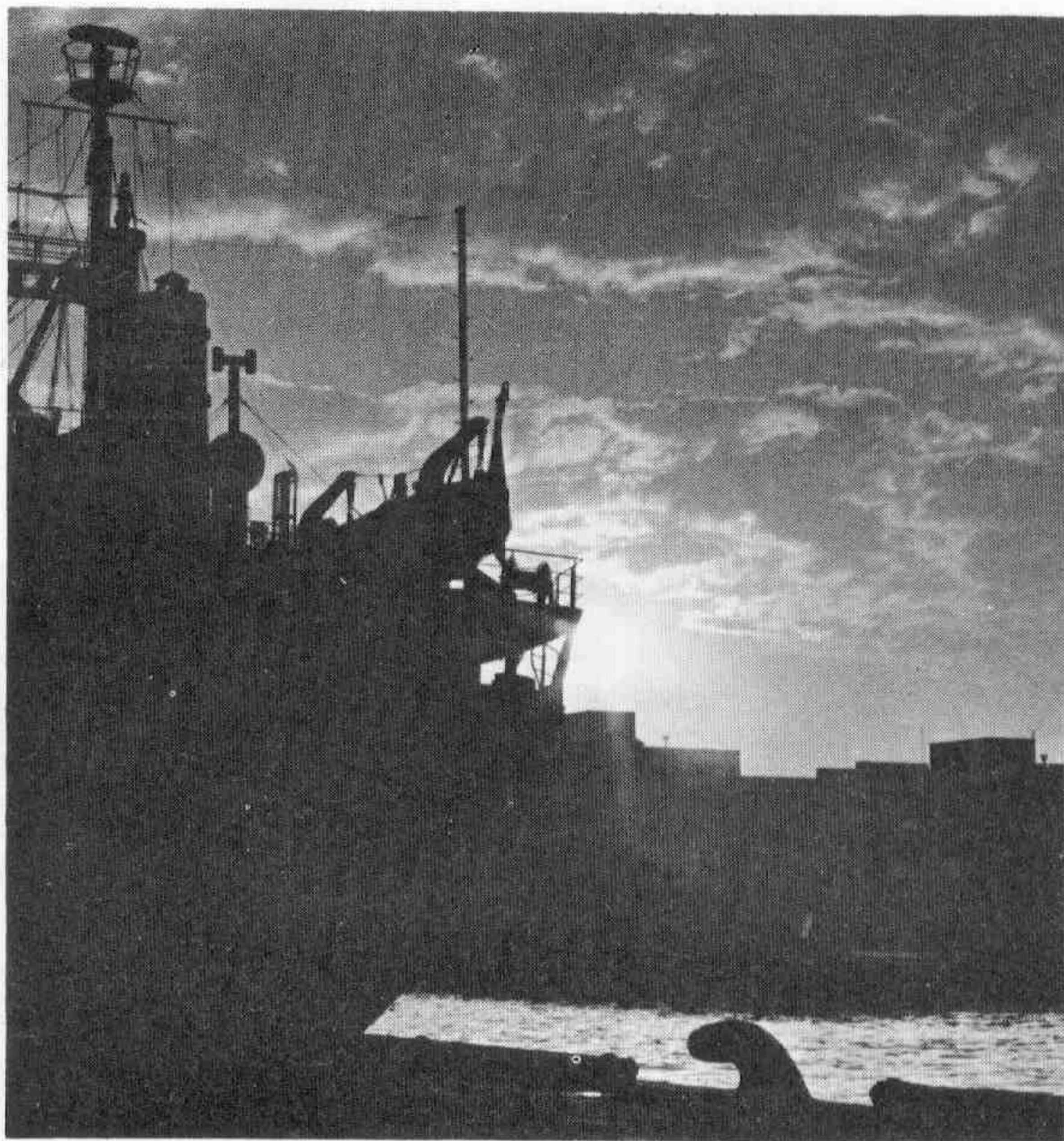

Setting ASA number (film speed)

Lift and rotate the shutter speed dial until the figure (6 to 6400) which corresponds with the ASA rating of your film is visible in the ASA window.

On the ASA dial the following figures are printed: 6 · 10 · 16 · 25 · 50 · 100 · 200 · 400 · 800 · 1600 · 3200 · 6400.

The dots (·) denote ASA 8, 12, 20, 32, 40, 64, 80, 125, 160, 250, 320, 500, 640, 1000, 1300, 2000, 2600, 4000, and 5200, respectively.

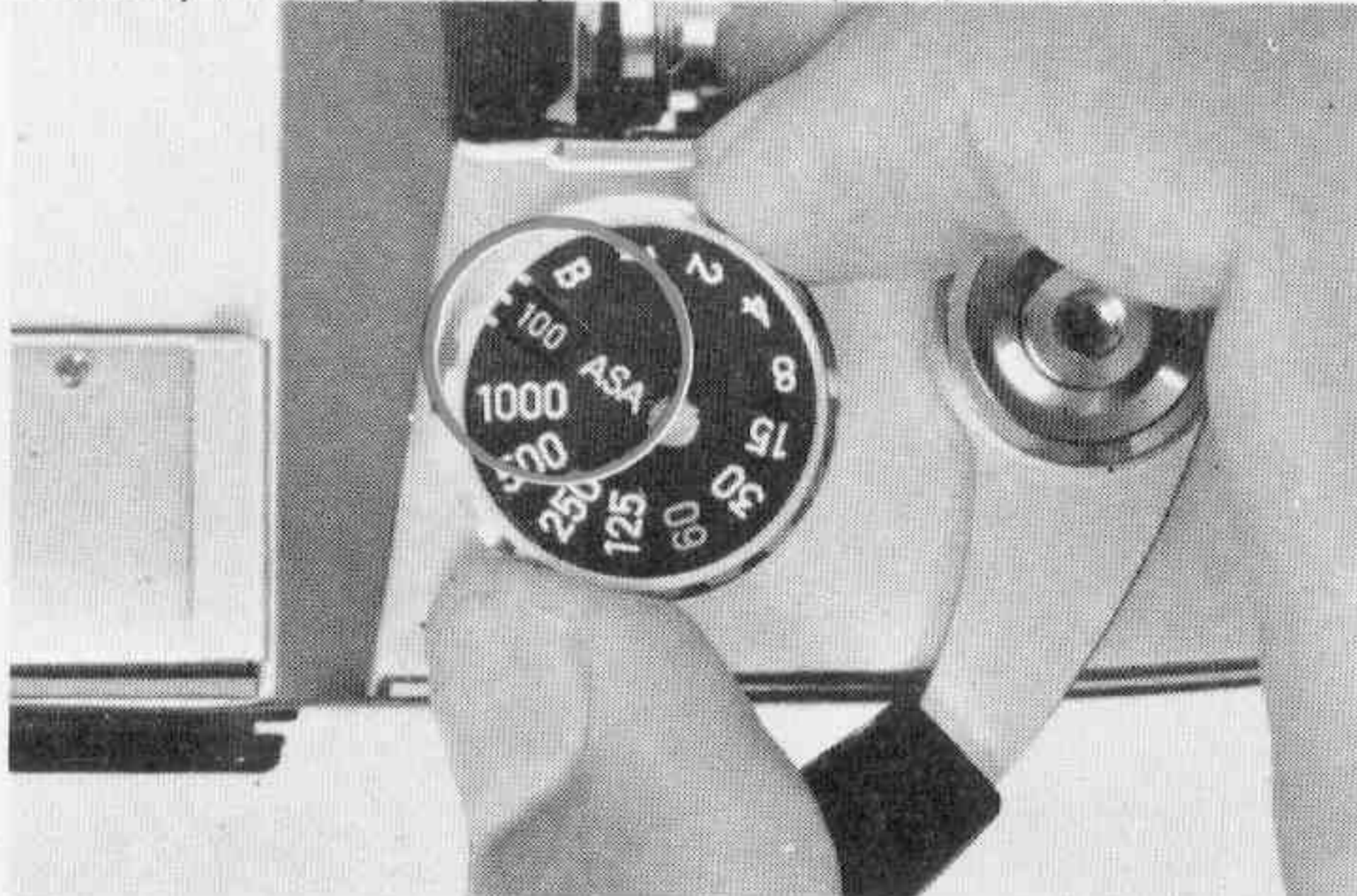

ASA/DIN conversion scale

When converting a DIN speed to the corresponding ASA speed or to remember a film speed, use this conversion scale. Turn the knob of the dial and set the film speed to the white pointer marked with ASA. In the case of ASA 100 film, for example, set the film speed as shown in the picture.

(The inner graduations are for the DIN).

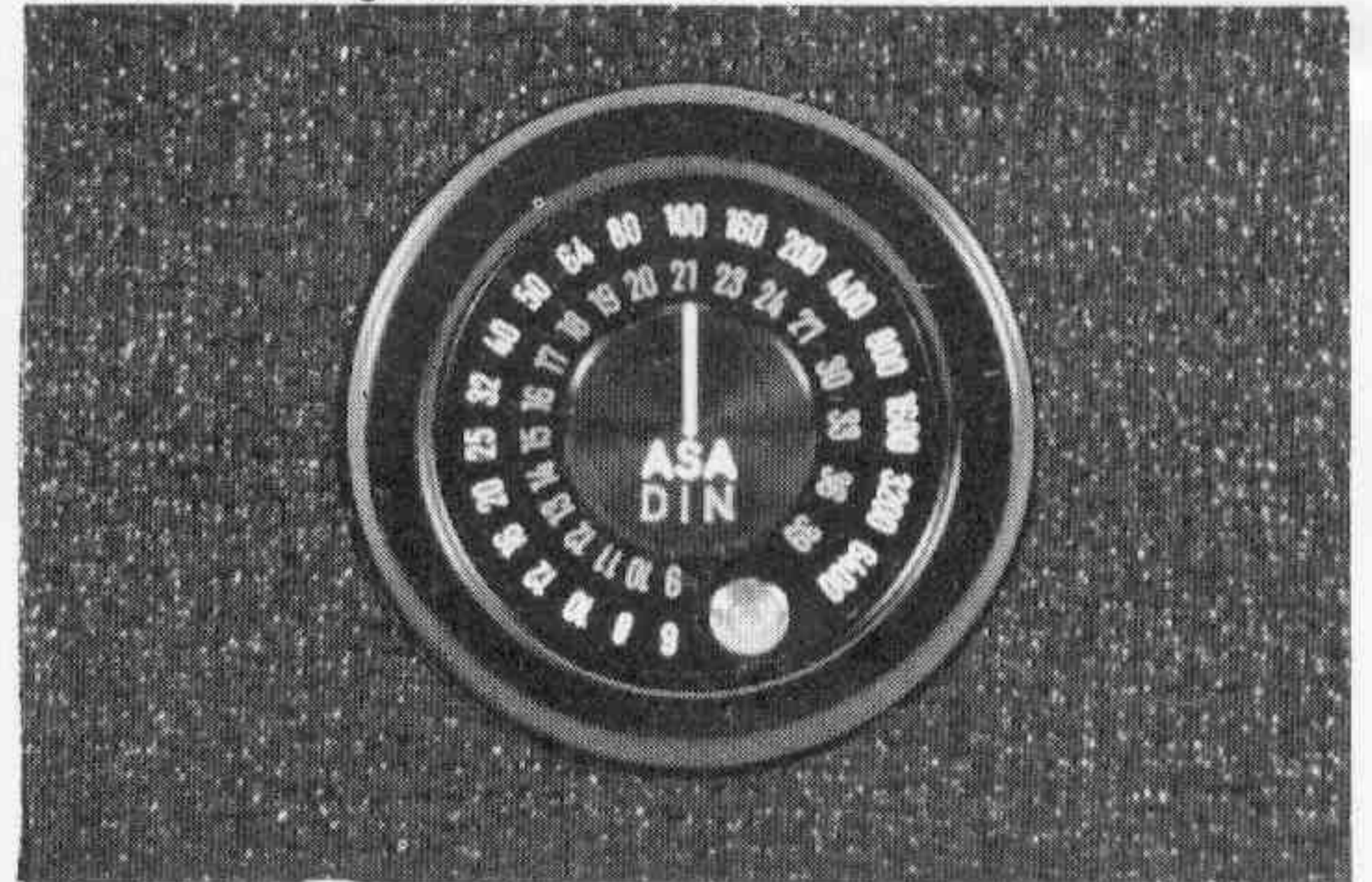

TAKING PICTURES

TTL with CLC: A new exposure measuring system

The Minolta SR-T 101 camera has a through-the-lens measuring system with CLC meter.

Minolta's exclusive, revolutionary CLC (Contrast Light Compensator) promises better photographic results with multiple split exposure measuring system.

Under normal photo-taking conditions this new system gives excellent results; under other conditions, such as in high-contrast scenes, the CLC feature prevents possible photo failures.

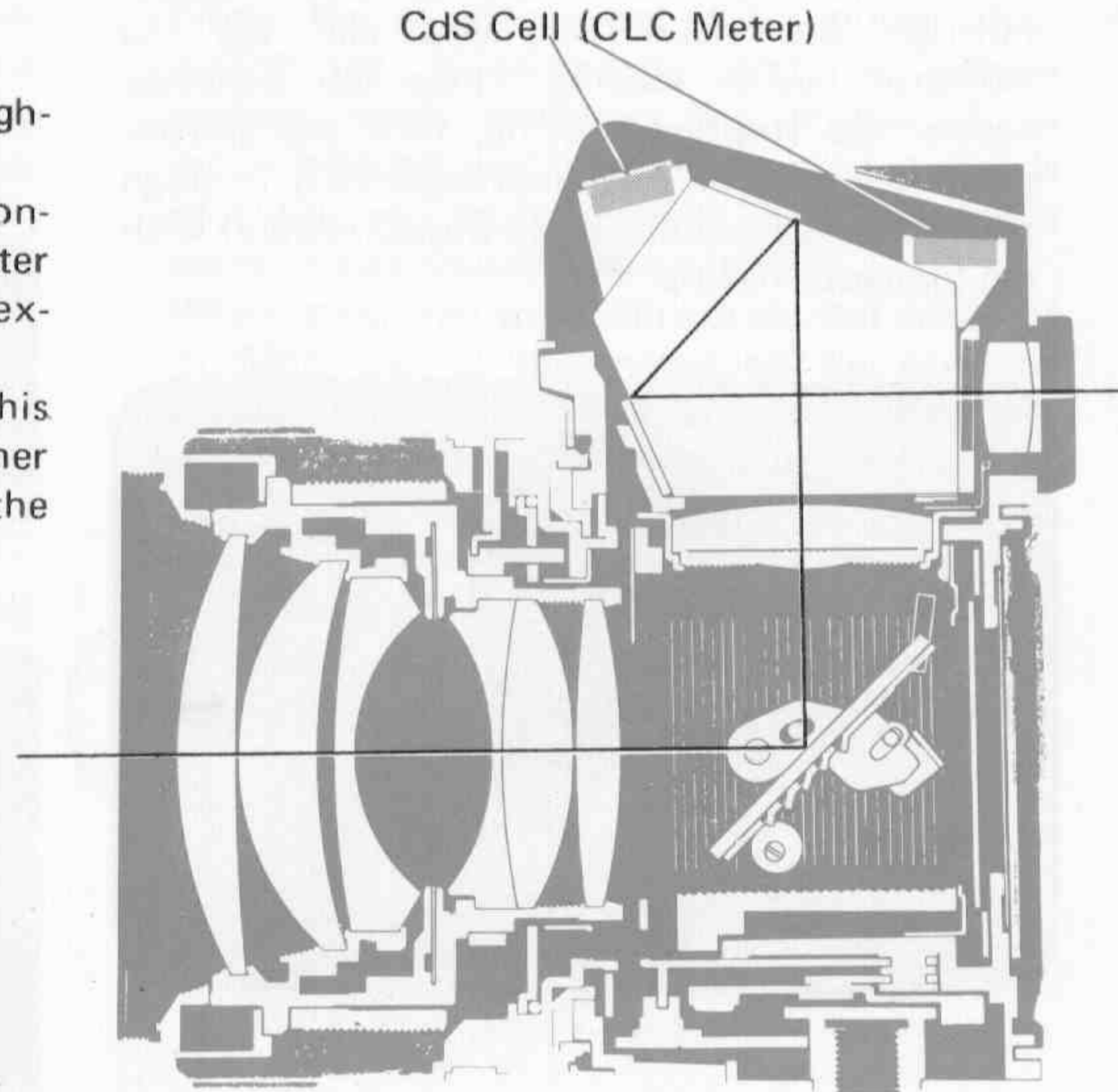

Setting the correct exposure

When aiming the camera at your subject through the viewfinder, you will see the indicator needle moving. Once the indicator needle has stopped moving, turn the shutter speed dial and/or the diaphragm ring to align the follow-up needle (circle-tipped needle) with the indicator needle.

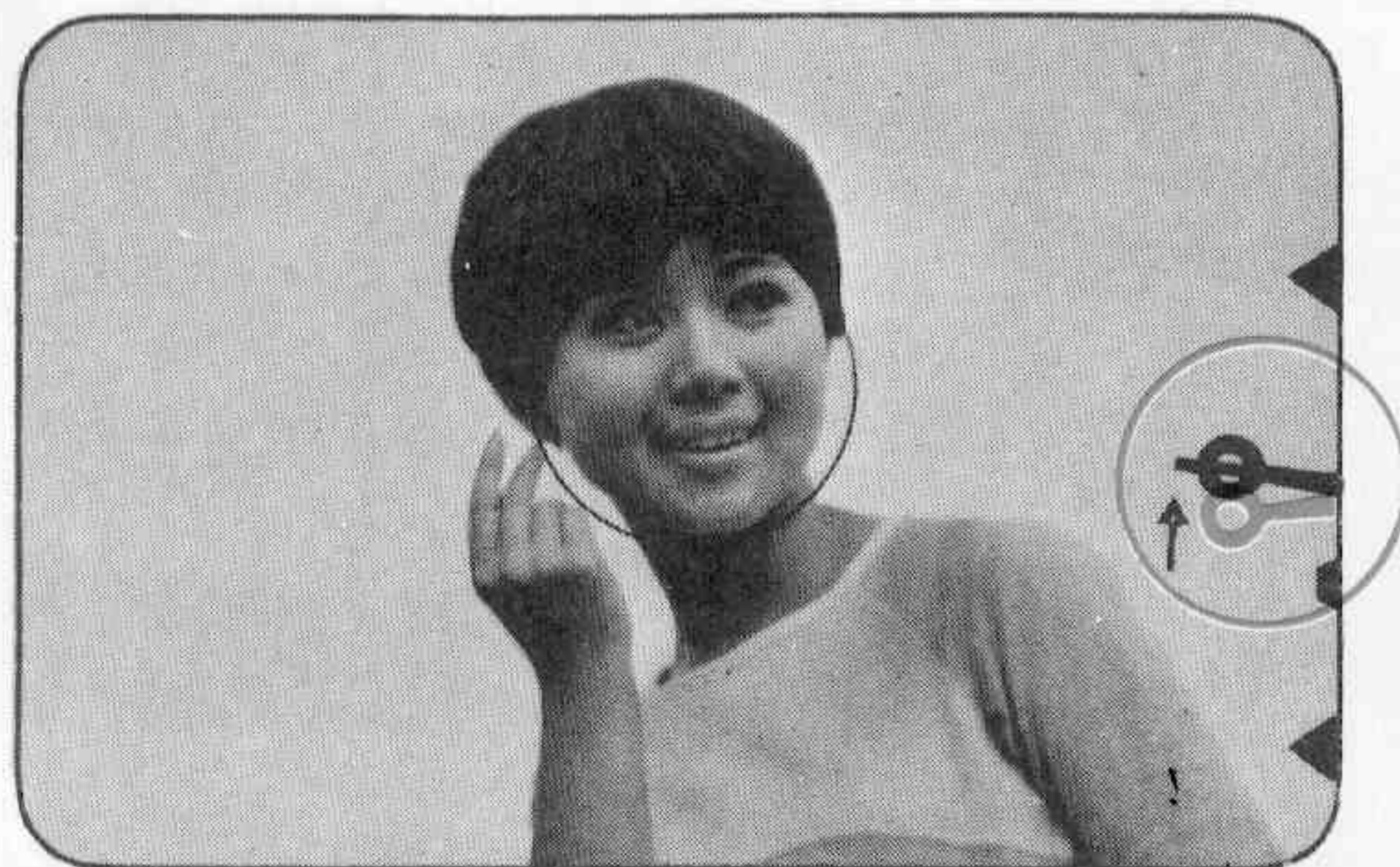

B 1 2 4 8 15 30 60 125 250 500 1000

The shutter speed is indicated in the viewfinder, when you set it on the shutter speed dial.

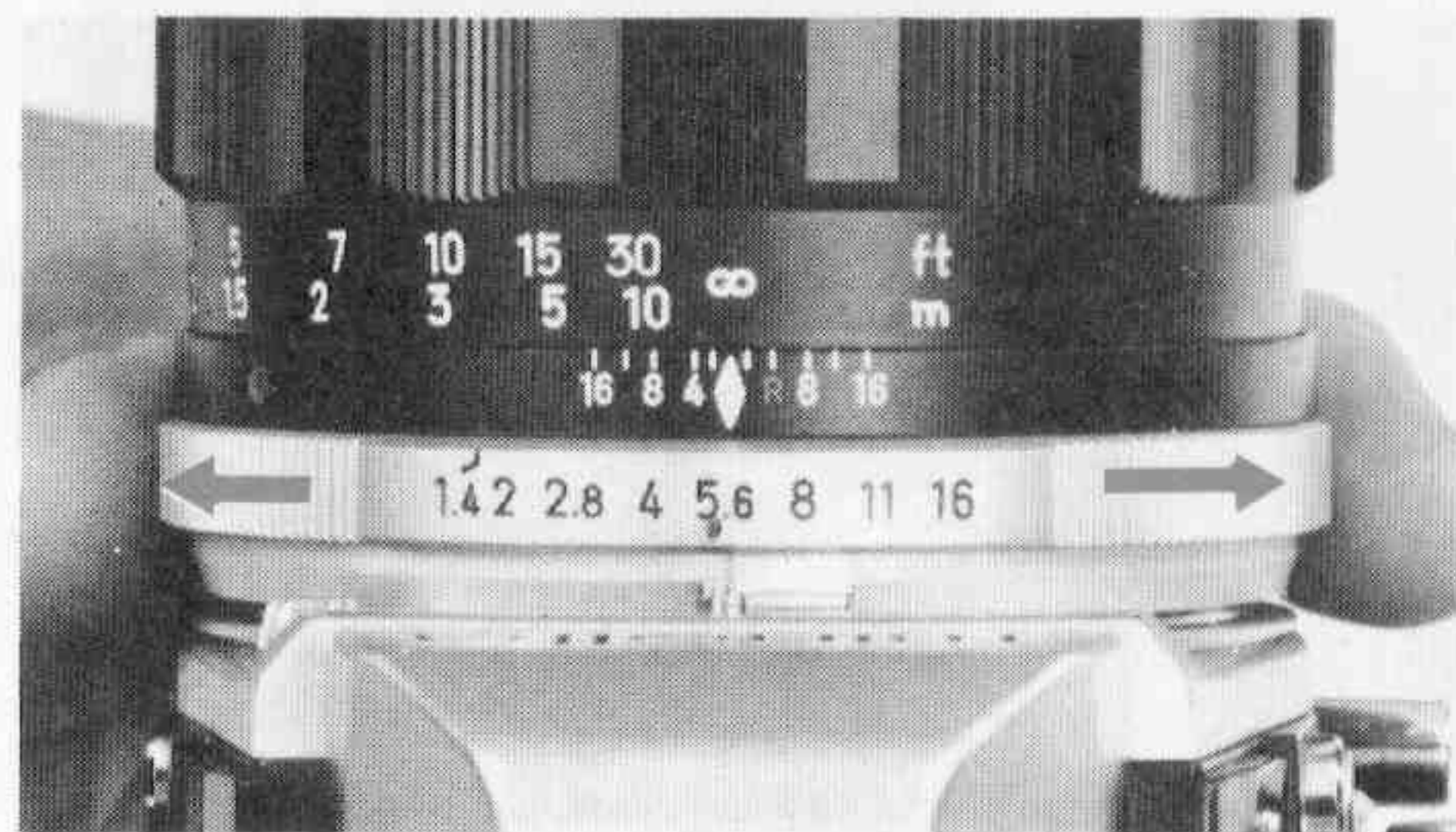
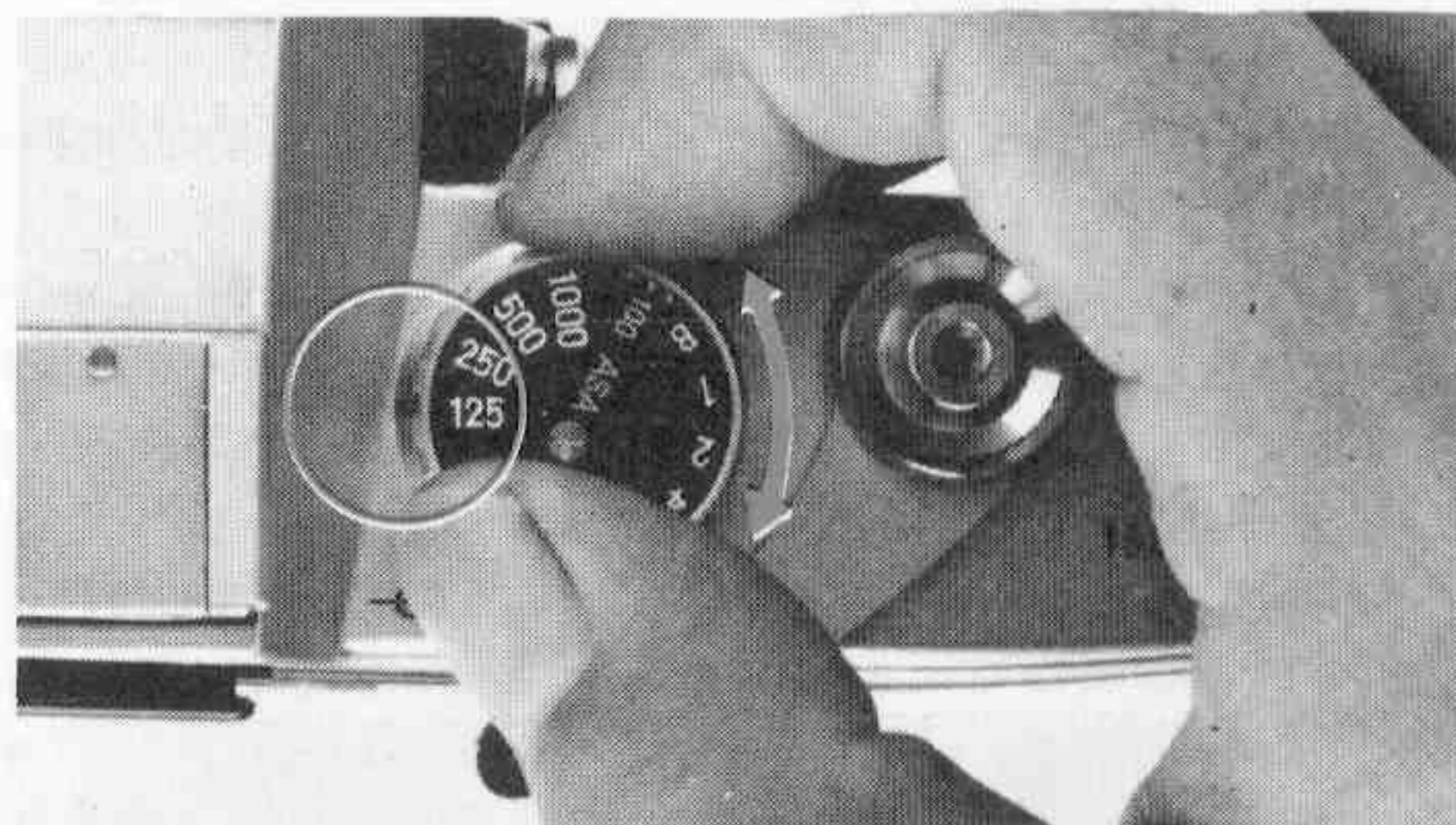

When the proper combination of aperture and shutter speed setting is made for correct exposure, the follow-up needle (which is coupled to the aperture, shutter speed and ASA speed settings) will align with the indicator needle over a range of EV 3 through EV 17 at ASA 100. The EV range will vary with film speed.

It is a recommended procedure to set the shutter speed first (depending on the motion or lack of motion of your subject or the overall lighting) and to then adjust the aperture.

If the needle fails to move when the diaphragm ring is rotated, this signals a need to adjust your shutter speed setting.

A shutter speed scale is visible in the viewfinder which permits you to make all exposure adjustments without removing the camera from your eye.

CAUTION:

- When setting the aperture first, be sure not to set the shutter speed between click stops.
- When the shutter speed is set slower than 1/30th sec., be extremely careful of camera motion while releasing the shutter. It is recommended that a tripod be used at speeds of 1/30th sec. or slower. For "Bulb" setting, a cable release should also be used.
- When using high-speed film, a shutter speed of 1/250th sec. is recommended for outdoor photography, and 1/30th sec. for indoor use.
- When photographing a group of people or a building requiring great depth of field, close down the diaphragm as much as possible. See the "depth of field" on page 25 for details.
- All metering should be done in horizontal position.

Shutter speed and aperture settings

The shutter speed (actually the period of time during which the shutter remains open) works in conjunction with the lens opening (aperture) to determine the amount of light striking the film. The higher the shutter speed, the more effectively it will momentarily "stop" the action of your subject.

To set shutter speed, simply rotate the shutter speed dial until the desired speed is aligned with the indicator on the camera body, or until it is centered between indicators on the shutter speed scale in the viewfinder.

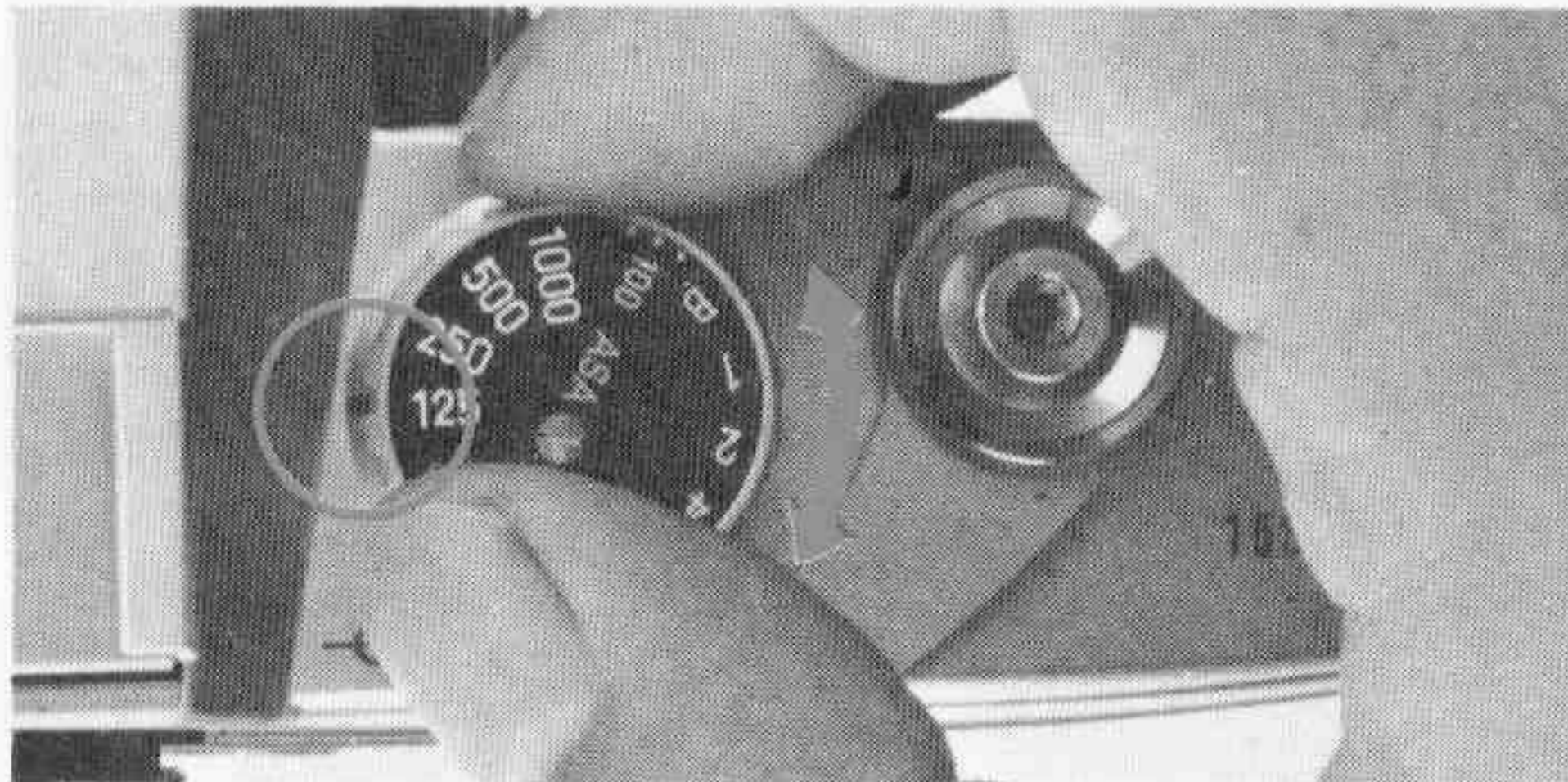

The figures of B and 1 through 1000 on the shutter speed dial indicate bulb action and shutter speeds from 1 to 1/1000th second. (At "B" the shutter will remain open indefinitely until pressure is removed from the release button.)

The aperture setting controls the light volume reaching the film in terms of area. In addition it determines the "depth of field." (See page 25.)



B 1 2 4 8 15 30 60 125 250 500 1000

The index for the aperture setting is the diamond (◆) symbol in front of the diaphragm ring. The ring is engraved with figures from 1.4 through 16 for the MC Rokkor 58mm F1.4 standard lens.

When the shutter speed remains constant, the light passing through the lens decreases 50% for every increase in the aperture F-number. (Example: When the diaphragm ring is turned from 2.8 to 4 the light volume decreases 50%.)

As the aperture figure decreases, the light passing through the lens increases. The relation between aperture (F-number) and light volume is shown in the diagram.

NOTE:

- "Click" stops are provided for intermediate aperture settings between any two full F-stops. Intermediate shutter speeds cannot be set.
- The figure "B" on the shutter speed dial is used when an exposure duration of over 1 second is required. The shutter will remain open while the shutter release is depressed.
- The red figure of "60" on the shutter speed dial is to be used in conjunction with an electronic flash unit.
- The shutter speed at which the camera is set is shown on the shutter speed scale visible in the viewfinder.
- Since light striking the film is affected by a combination of aperture and shutter speed, exposure can be adjusted by changing either or both of these settings.

F-No.	1.2	1.4	2	2.8	4	5.6	8	11	16
Light									
Volume	3	2	1	1/2	1/4	1/8	1/16	1/32	1/64

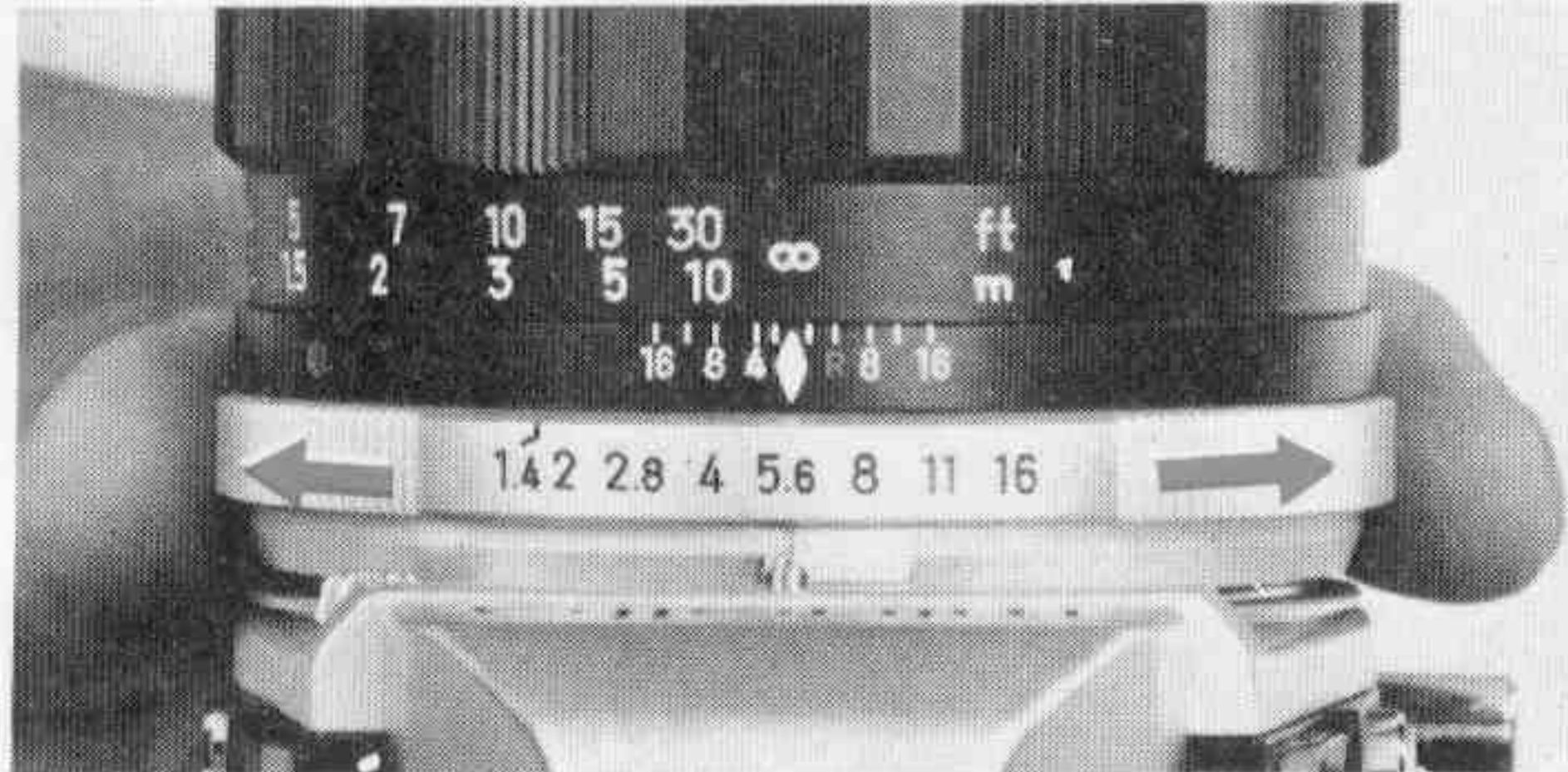

Focusing the camera

To focus, hold the camera to your eye and turn the lens-focusing ring clockwise or counter-clockwise until a sharp image appears in the center spot of the viewfinder. This center spot, the microprism, consists of many diagonal lines which will aid in ultra-sharp and rapid focusing.

In focus



Out of focus

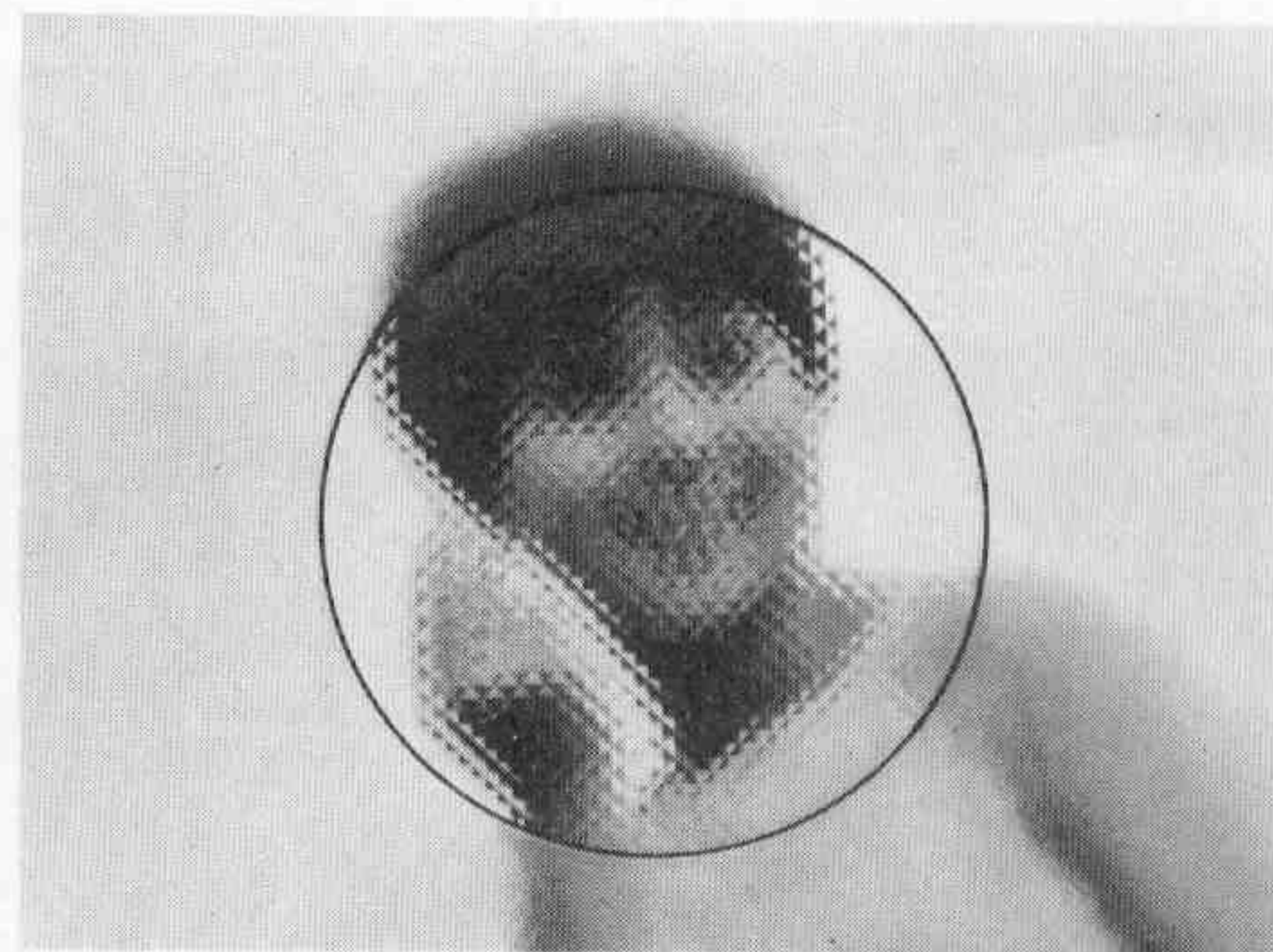

Holding the camera

The camera may be held horizontally or vertically. In either case, be sure to hold the camera in a comfortable position. This will help to prevent movement of the camera during exposure and avoid blurred pictures.



NOTE:

- Pressing the camera gently against your face, or supporting the elbow of the hand holding the camera against your body, will aid in steady holding.
- The camera will tend to move more when used in the vertical position.

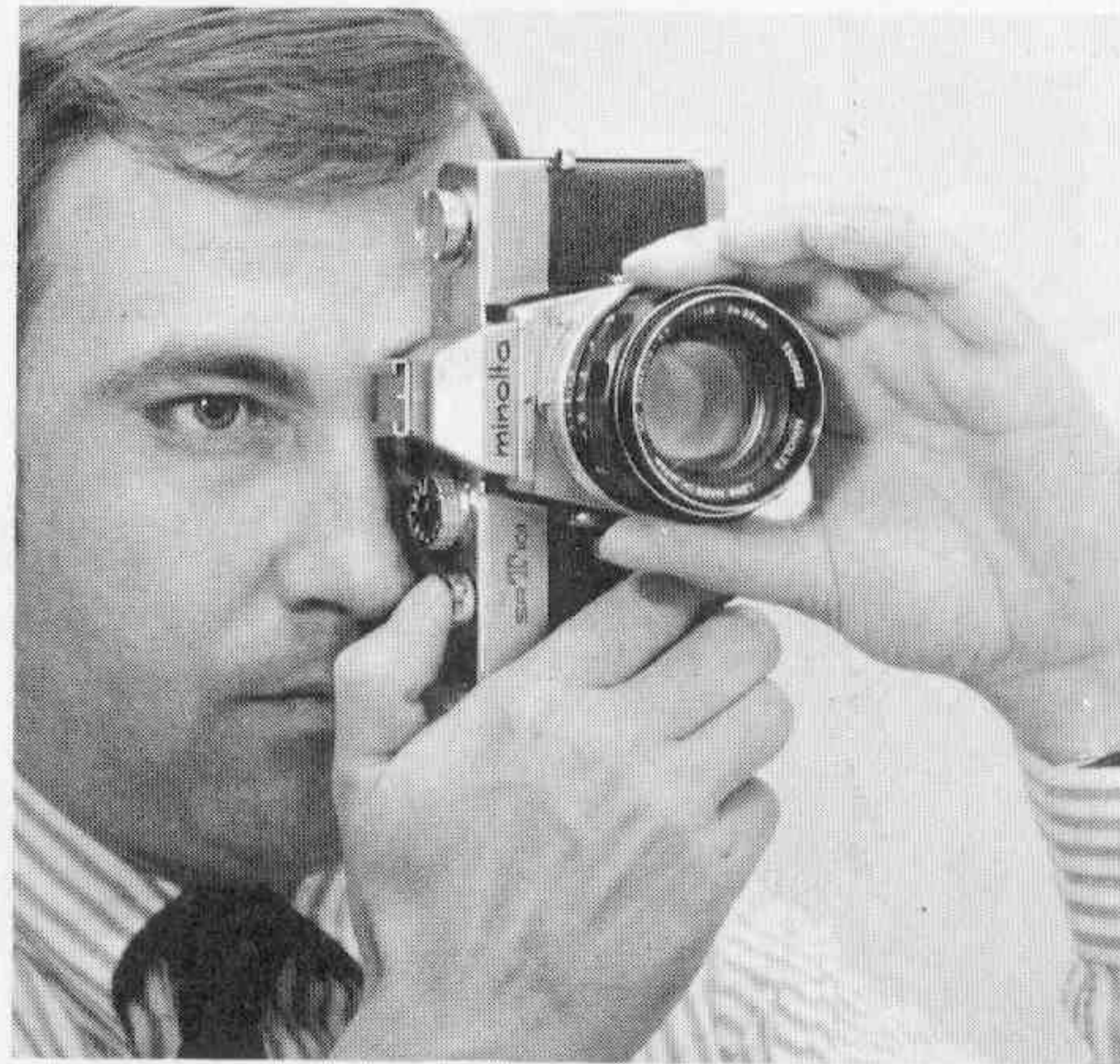

Attaching flash unit

Slide the foot of the flash unit into the camera's accessory shoe from the back of the camera, then tighten the screw of the flash unit for secure, wobble-free operation.

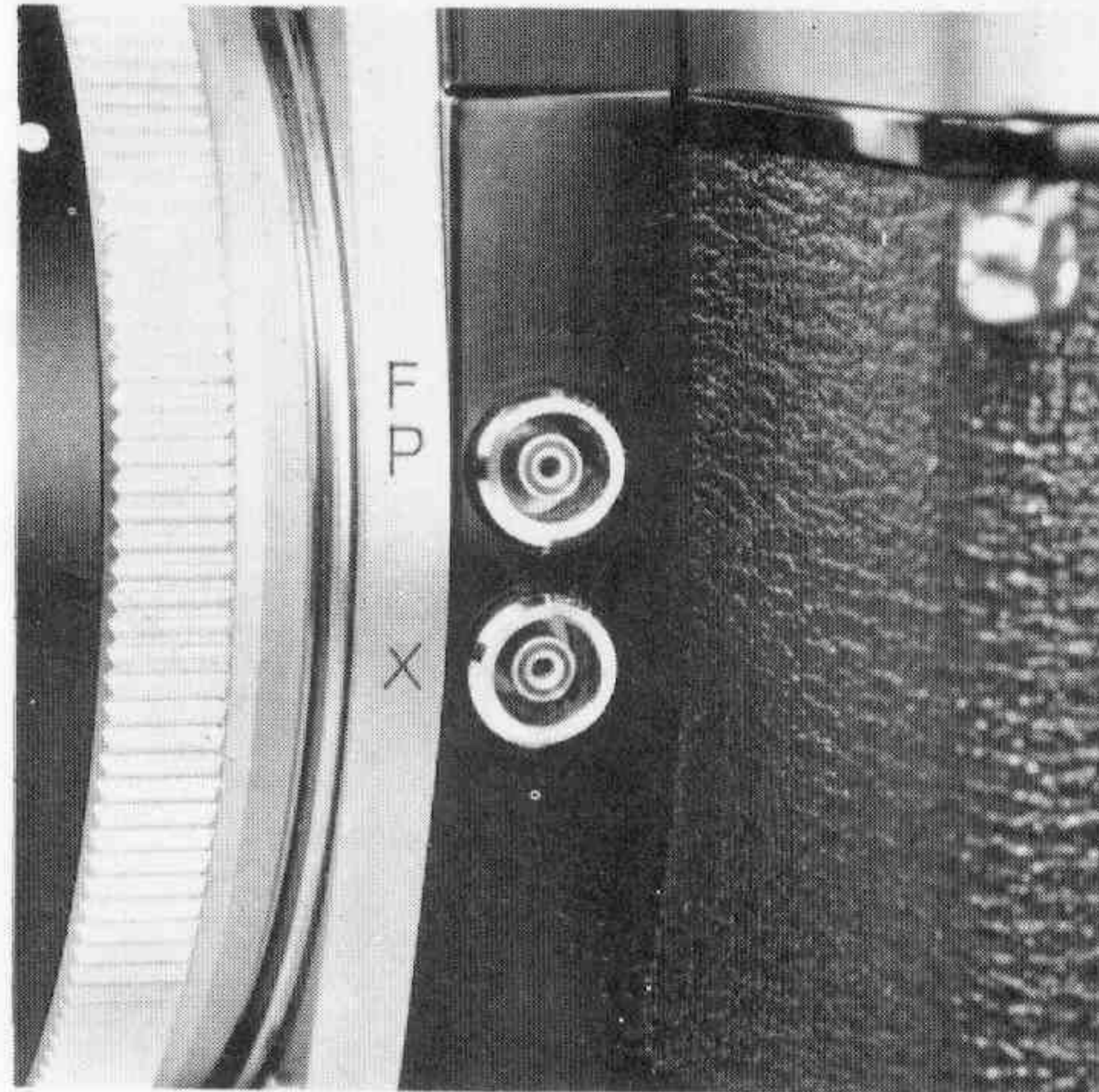
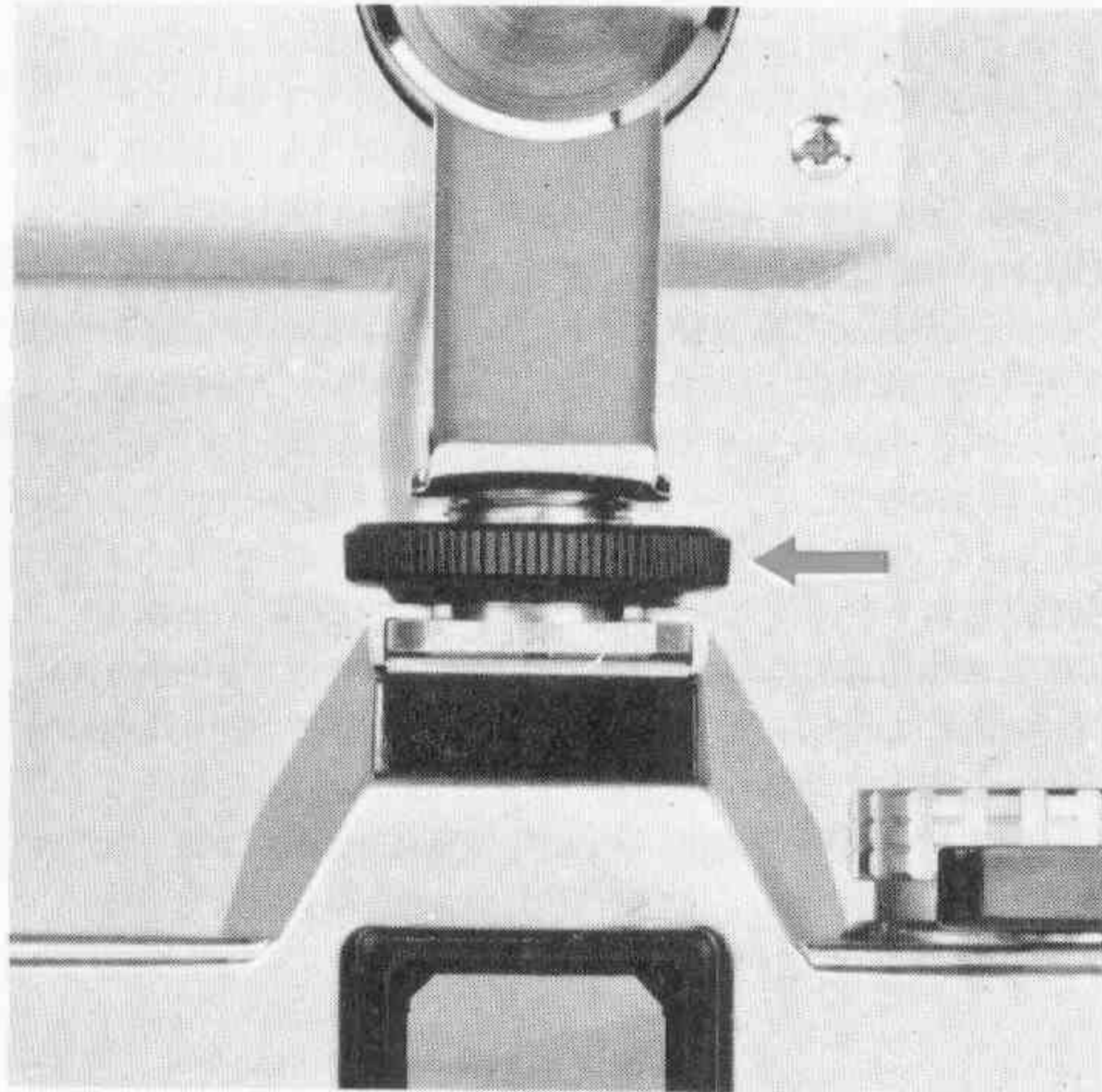

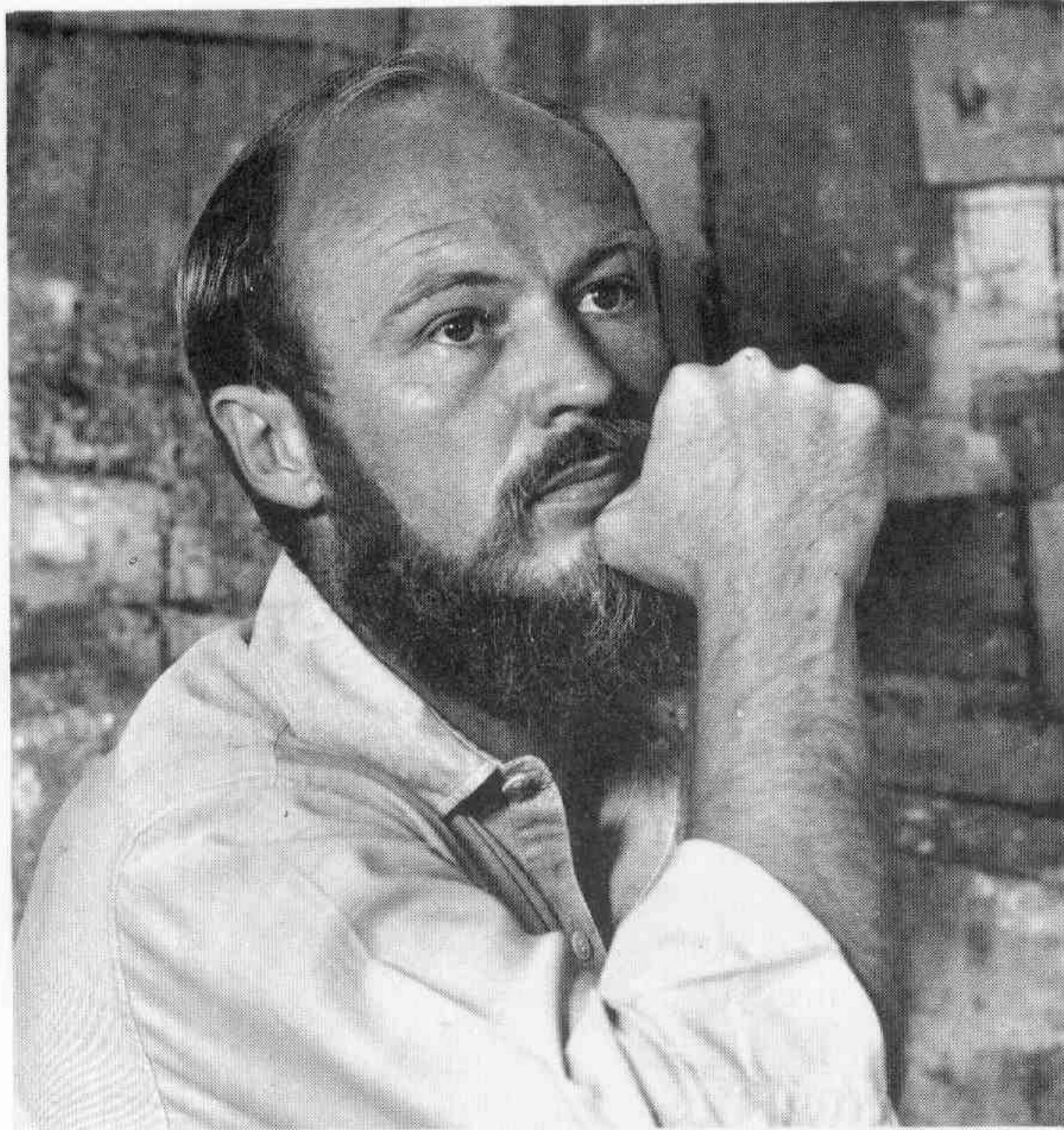

Setting correct exposure

To determine the correct aperture for flash photography, get the "guide number" of the flash bulb you are using. Then make this simple computation:

$$\frac{\text{Guide Number}}{\text{Distance to Subject}} = \text{Aperture Setting (F-stop)}$$

For example, when flash bulb guided number is 80 (in feet) and the distance to the subject is 10 feet (with ASA 100 film, using shutter speed or 1/60th sec.),

the F-stop is: $\frac{80}{10} = 8$

NOTE:

- When using M-class flash bulbs, a shutter speed of 1/15th sec. or slower is recommended.
- Use "blue" flash bulbs generally for color photography.

MORE ADVANCED GUIDES

Depth of field

Lens aperture controls depth of field

When the lens is accurately focused on a subject, there is a certain depth both in the foreground and the background, which is also considered to be in focus. This area is known as the "depth of field."

The sharp focus area in the foreground is usually shallower than the sharp focus area in the background.

Depth of field has the following characteristics which should be considered when pictures are composed:

1. As the lens aperture decreases, the area of sharp focus increases. As lens aperture increases, the area of sharp focus decreases.
2. As the distance from camera to subject is increased, so is the area of sharp focus.
3. A telephoto lens has a shallower depth of field than a wideangle lens.

Full aperture opening

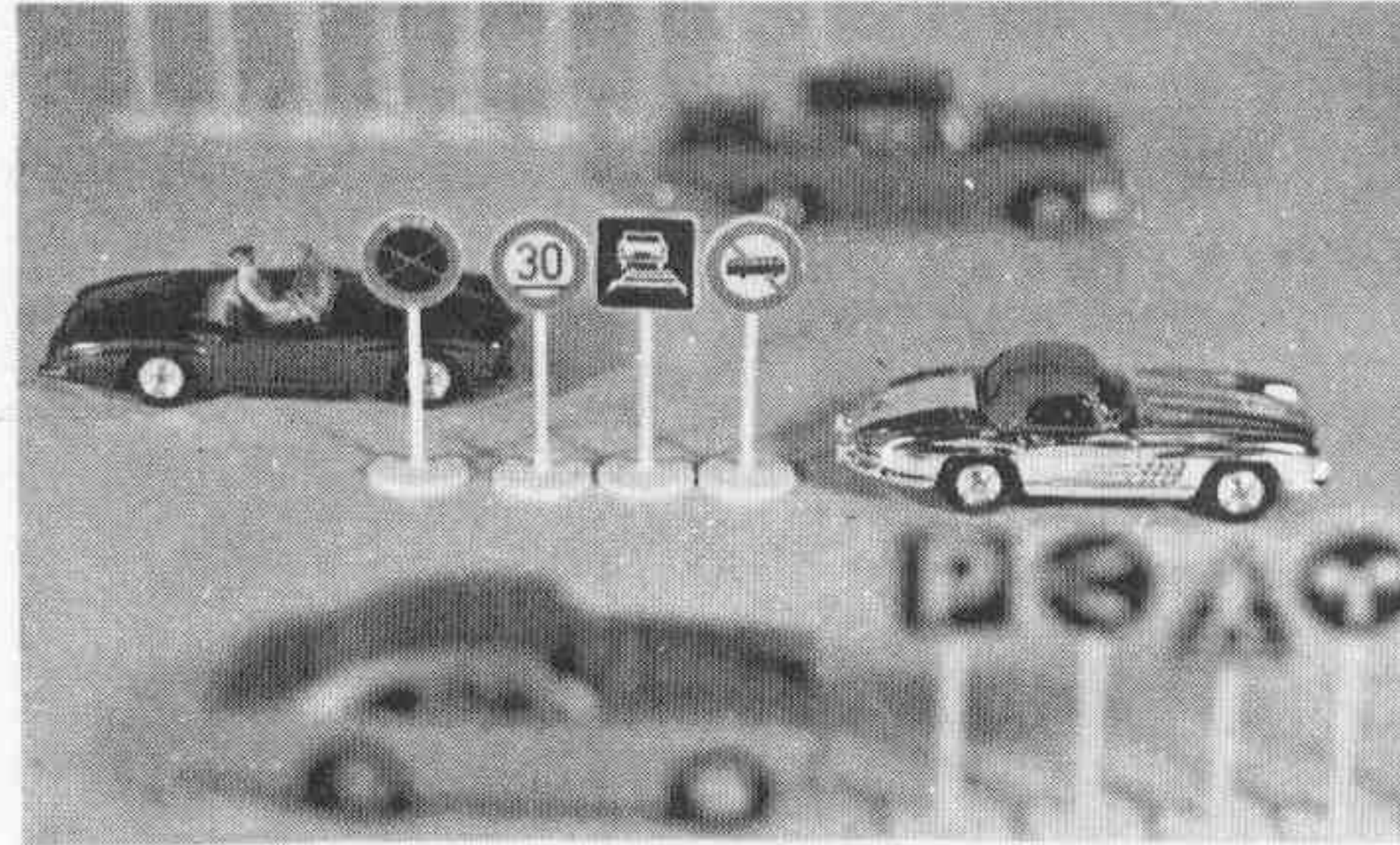

Small aperture opening



The depth-of-field scale engraved on lens barrel enables you to determine the depth of field in which focus will be acceptably sharp. For example, if you focus on a subject 15 feet away and use an F8 aperture, read the distance opposite the two figures 8. In this case the picture will be sharp from approximately 11 to 23 feet. (See next page.)

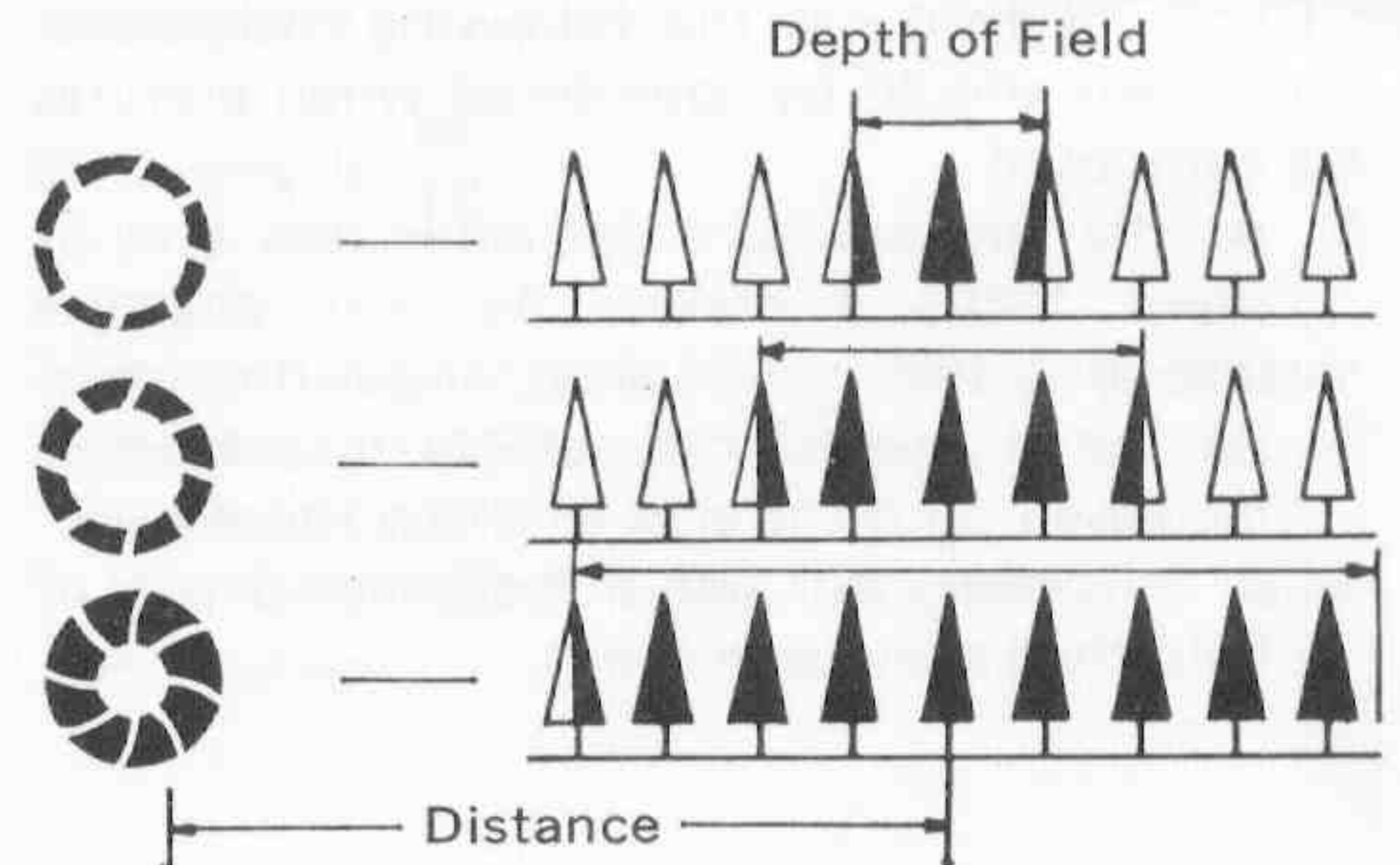
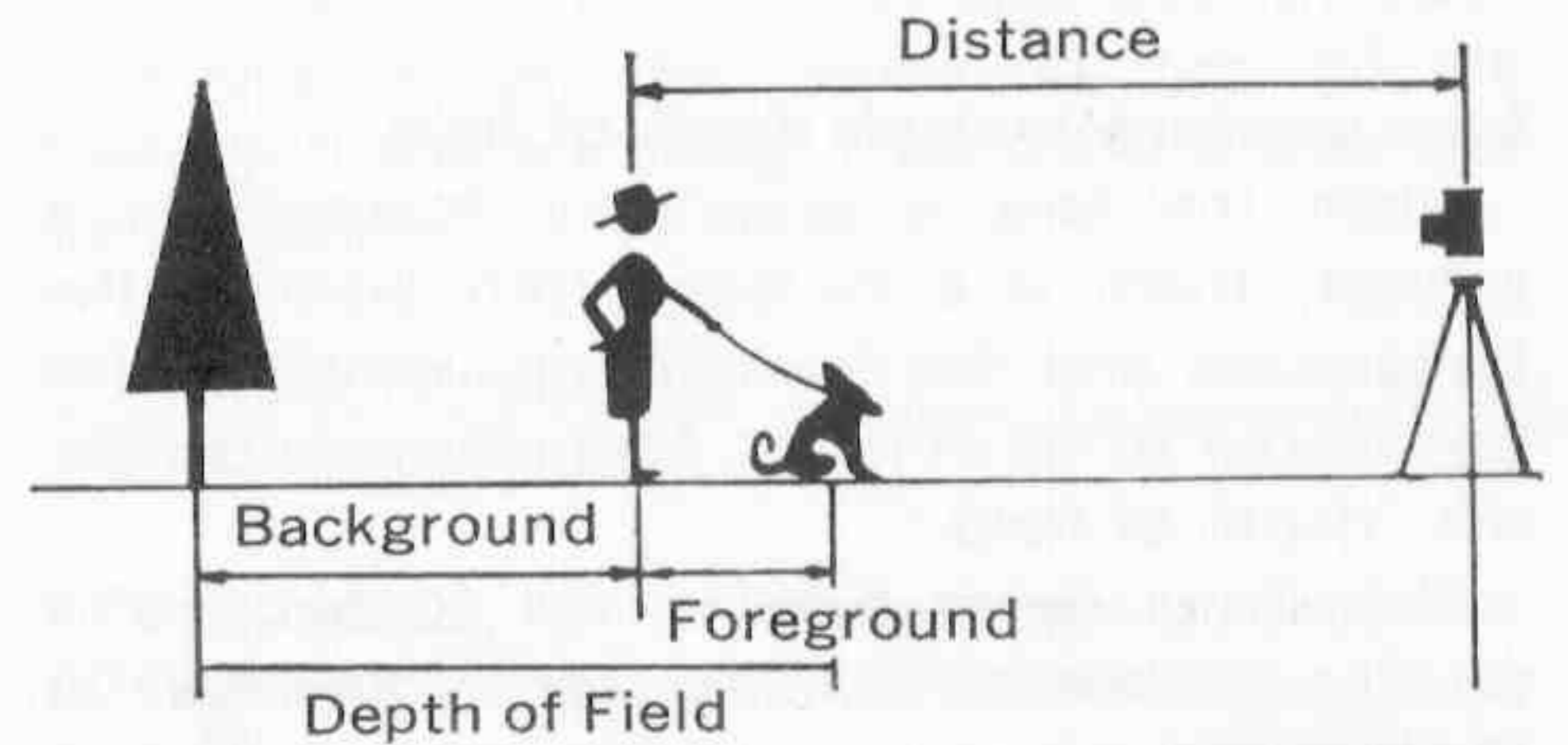

Depth-of-field table of MC Rokkor 58mm F1.2 and F1.4 Lens (in feet)

F No. / Dis (ft)	1.2	1.4	2	2.8	4	5.6	8	11	16
∞	∞ 282'	∞ 244'	∞ 171'	∞ 121'	∞ 85'	∞ 61'	∞ 43'	∞ 30'	∞ 22'
30	33' 6" 27' 2"	34' 2" 26' 9"	36' 3" 25' 7"	39' 9" 24' 1"	45' 11" 22' 4"	59' 20' 2"	98' 17' 9"	∞ 15' 2"	∞ 12' 8"
15	15' 10" 14' 3"	15' 11" 14' 2"	16' 5" 13' 10"	17' 1" 13' 5"	18' 1" 12' 10"	19' 9" 12' 1"	22' 9" 11' 3"	29' 10' 2"	47' 7" 9'
10	10' 4" 9' 8 ¹ / ₁₆ "	10' 5" 9' 8"	10' 7" 9' 6"	10' 10" 9' 3"	11' 3" 9'	11' 10" 8' 8"	12' 11" 8' 2"	14' 8" 7' 7"	18' 2" 6' 11"
7	7' 2 ⁷ / ₁₆ " 6' 10 ¹ / ₁₆ "	7' 2" 6' 10"	7' 3" 6' 9"	7' 5" 6' 8"	7' 7" 6' 6"	7' 10" 6' 4"	8' 3" 6' 1"	8' 11" 5' 9"	10' 1" 5' 5"
5	5' 15 ¹⁵ / ₁₆ " 4' 11"	5' 1" 4' 11"	5' 2" 4' 10"	5' 2" 4' 10"	5' 3" 4' 9"	5' 5" 4' 8"	5' 7" 4' 6"	5' 10" 4' 4"	6' 4" 4' 2"
4	4' 9 ⁹ / ₁₆ " 3' 11 ³ / ₈ "	4' 1" 3' 11"	4' 1" 3' 11"	4' 1" 3' 11"	4' 2" 3' 10"	4' 3" 3' 9"	4' 4" 3' 8"	4' 6" 3' 7"	4' 9" 3' 5"
3.5	3' 6 ⁷ / ₁₆ " 3' 5 ¹ / ₂ "	3' 6 ¹ / ₂ " 3' 5 ¹ / ₂ "	3' 6 ³ / ₄ " 3' 5 ¹ / ₄ "	3' 7" 3' 5"	3' 7 ¹ / ₂ " 3' 4 ¹ / ₂ "	3' 8 ¹ / ₄ " 3' 4"	3' 9 ¹ / ₄ " 3' 3 ¹ / ₄ "	3' 10 ³ / ₄ " 3' 2 ¹ / ₄ "	4' 3 ³ / ₄ " 3' 3 ³ / ₄ "
3	3' 5 ⁵ / ₁₆ " 2' 11 ⁵ / ₈ "	3' 1 ¹ / ₂ " 2' 11 ⁵ / ₈ "	3' 1 ¹ / ₂ " 2' 11 ¹ / ₂ "	3' 3 ³ / ₄ " 2' 11 ¹ / ₄ "	3' 1" 2' 11"	3' 1 ¹ / ₂ " 2' 10 ¹ / ₂ "	3' 2 ¹ / ₄ " 2' 10"	3' 3 ¹ / ₄ " 2' 9 ¹ / ₄ "	3' 4 ³ / ₄ " 2' 8 ¹ / ₄ "
2.5	2' 6 ³ / ₁₆ " 2' 5 ³ / ₄ "	2' 6 ¹ / ₄ " 2' 5 ³ / ₄ "	2' 6 ¹ / ₂ " 2' 5 ³ / ₄ "	2' 6 ¹ / ₂ " 2' 5 ¹ / ₂ "	2' 6 ³ / ₄ " 2' 5 ¹ / ₄ "	2' 7" 2' 5"	2' 7 ¹ / ₂ " 2' 4 ³ / ₄ "	2' 8 ¹ / ₄ " 2' 4 ¹ / ₄ "	2' 9" 2' 3 ¹ / ₂ "
2.25	2' 3 ¹ / ₈ " 2' 2 ¹³ / ₁₆ "	2' 3 ¹ / ₄ " 2' 2 ³ / ₄ "	2' 3 ¹ / ₄ " 2' 2 ³ / ₄ "	2' 3 ¹ / ₂ " 2' 2 ³ / ₄ "	2' 3 ¹ / ₂ " 2' 2 ¹ / ₂ "	2' 3 ³ / ₄ " 2' 2 ¹ / ₄ "	2' 4 ¹ / ₄ " 2' 2"	2' 4 ³ / ₄ " 2' 1 ¹ / ₂ "	2' 5 ¹ / ₂ " 2' 1"
2	2' 1 ¹ / ₈ " 1' 11 ¹³ / ₁₆ "	2' 1 ¹ / ₄ " 1' 11 ³ / ₄ "	2' 1 ¹ / ₄ " 1' 11 ³ / ₄ "	2' 1 ¹ / ₄ " 1' 11 ³ / ₄ "	2' 1 ¹ / ₂ " 1' 11 ³ / ₄ "	2' 3 ³ / ₄ " 1' 11 ¹ / ₂ "	2' 3 ³ / ₄ " 1' 11 ¹ / ₄ "	2' 1 ¹ / ₄ " 1' 10 ³ / ₄ "	2' 1 ³ / ₄ " 1' 10 ¹ / ₂ "

Depth-of-field table of MC Rokkor 58mm F1.2 and F1.4 Lens (in meters)

28

Dis (m) \ F No.	1.2	1.4	2	2.8	4	5.6	8	11	16
∞	∞ 86.0	∞ 74.2	∞ 53.8	∞ 38.0	∞ 26.9	∞ 19.1	∞ 13.5	∞ 9.6	∞ 6.8
10	11.3 9.0	11.5 8.8	12.2 8.5	13.5 8.0	15.8 7.3	20.8 6.6	37.7 5.8	∞ 4.9	∞ 4.1
5	5.3 4.7	5.4 4.7	5.5 4.6	5.7 4.4	6.1 4.2	6.7 4.0	7.8 3.7	10.2 3.3	18.1 2.9
3	3.10 2.90	3.12 2.89	3.17 2.85	3.24 2.79	3.36 2.71	3.53 2.61	3.81 2.48	4.29 2.31	5.22 2.11
2	2.04 1.96	2.05 1.95	2.07 1.93	2.10 1.91	2.15 1.87	2.22 1.82	2.32 1.76	2.48 1.68	2.76 1.57
1.5	1.52 1.48	1.53 1.47	1.54 1.46	1.56 1.45	1.58 1.43	1.61 1.40	1.67 1.37	1.75 1.32	1.88 1.25
1.2	1.22 1.19	1.22 1.18	1.22 1.18	1.23 1.17	1.25 1.16	1.27 1.14	1.30 1.11	1.35 1.08	1.42 1.04
1	1.01 0.99	1.01 0.99	1.02 0.99	1.02 0.98	1.03 0.97	1.05 0.96	1.07 0.94	1.10 0.92	1.14 0.89
0.9	0.91 0.89	0.91 0.89	0.91 0.89	0.92 0.88	0.93 0.88	0.94 0.87	0.95 0.85	0.98 0.84	1.01 0.81
0.8	0.81 0.79	0.81 0.79	0.81 0.79	0.81 0.79	0.82 0.78	0.83 0.77	0.84 0.76	0.86 0.75	0.89 0.73
0.7	0.71 0.70	0.71 0.70	0.71 0.70	0.71 0.69	0.71 0.69	0.72 0.68	0.73 0.67	0.74 0.66	0.76 0.65
0.6	0.60 0.60	0.60 0.60	0.61 0.60	0.61 0.59	0.61 0.59	0.61 0.59	0.62 0.58	0.63 0.57	0.64 0.56

Depth-of-field table of MC Rokkor 55mm F1.7 Lens (in feet)

F No. \ Dis (m)	1.7	2.8	4	5.6	8	11	16
∞	∞ 175'	∞ 107'	∞ 75' 5"	∞ 53' 5"	∞ 37' 9"	∞ 26' 9"	∞ 19'
30	36' 1" 25' 8"	41' 6" 23' 6"	49' 5" 21' 7"	67' 7" 19' 4"	141' 16'10"	∞ 14' 3"	∞ 11' 9"
15	16' 4" 13'10"	17' 4" 13' 2"	18' 7" 12' 7"	20' 8" 11'10"	24' 6" 10'10"	33' 2" 9' 9"	67' 4" 8' 6"
10	10' 7" 9' 5 $\frac{7}{8}$ "	10'12" 9' 2 $\frac{1}{4}$ "	11' 5" 8'10 $\frac{5}{8}$ "	12' 2" 8' 5 $\frac{7}{8}$ "	13' 5" 7'11 $\frac{7}{8}$ "	15' 7" 7' 4 $\frac{5}{8}$ "	20' 5" 6' 8"
7	7' 3 $\frac{1}{4}$ " 6' 8"	7' 5 $\frac{1}{2}$ " 6' 7 $\frac{1}{4}$ "	7' 7 $\frac{7}{8}$ " 6' 5 $\frac{3}{8}$ "	7'11 $\frac{3}{4}$ " 6' 2 $\frac{7}{8}$ "	8' 5 $\frac{5}{8}$ " 5'11 $\frac{3}{4}$ "	9' 3 $\frac{3}{8}$ " 5' 7 $\frac{5}{8}$ "	10' 9" 5' 2 $\frac{5}{8}$ "
5	5' 1 $\frac{1}{2}$ " 4'10 $\frac{1}{2}$ "	5' 2 $\frac{5}{8}$ " 4' 9 $\frac{5}{8}$ "	5' 3 $\frac{3}{4}$ " 4' 8 $\frac{5}{8}$ "	5' 5 $\frac{1}{2}$ " 4' 7 $\frac{3}{8}$ "	5' 8 $\frac{1}{8}$ " 4' 5 $\frac{5}{8}$ "	6' $\frac{1}{4}$ " 4' 3 $\frac{3}{8}$ "	6' 7" 4' $\frac{1}{2}$ "
4	4' 1" 3'11 $\frac{1}{8}$ "	4' 1 $\frac{5}{8}$ " 3'10 $\frac{1}{2}$ "	4' 2 $\frac{3}{8}$ " 3' 9 $\frac{7}{8}$ "	4' 3 $\frac{3}{8}$ " 3' 9 $\frac{1}{8}$ "	4' 4 $\frac{7}{8}$ " 3' 8"	4' 7 $\frac{1}{4}$ " 3' 6 $\frac{1}{2}$ "	4'11" 3' 4 $\frac{1}{2}$ "
3.5	3' 6 $\frac{3}{4}$ " 3' 5 $\frac{3}{8}$ "	3' 7 $\frac{1}{4}$ " 3' 4 $\frac{7}{8}$ "	3' 7 $\frac{3}{4}$ " 3' 4 $\frac{3}{8}$ "	3' 8 $\frac{1}{2}$ " 3' 3 $\frac{3}{4}$ "	3' 9 $\frac{5}{8}$ " 3' 3"	3'11 $\frac{1}{4}$ " 3' 1 $\frac{3}{4}$ "	4' 2" 3' $\frac{1}{4}$ "
3	3' $\frac{1}{2}$ " 2'11 $\frac{1}{2}$ "	3' $\frac{7}{8}$ " 2'11 $\frac{1}{8}$ "	3' 1 $\frac{1}{4}$ " 2'10 $\frac{7}{8}$ "	3' 1 $\frac{3}{4}$ " 2'10 $\frac{3}{8}$ "	3' 2 $\frac{1}{2}$ " 2' 9 $\frac{3}{4}$ "	3' 3 $\frac{3}{4}$ " 2' 9"	3' 5 $\frac{1}{2}$ " 2' 7 $\frac{3}{4}$ "
2.5	2' 6 $\frac{3}{8}$ " 2' 5 $\frac{3}{4}$ "	2' 6 $\frac{1}{2}$ " 2' 5 $\frac{1}{2}$ "	2' 6 $\frac{3}{4}$ " 2' 5 $\frac{1}{4}$ "	2' 7 $\frac{1}{8}$ " 2' 5"	2' 7 $\frac{3}{4}$ " 2' 4 $\frac{1}{2}$ "	2' 8 $\frac{3}{8}$ " 2' 4"	2' 9 $\frac{5}{8}$ " 2' 3 $\frac{1}{4}$ "
2.25	2' 3 $\frac{1}{4}$ " 2' 2 $\frac{3}{4}$ "	2' 3 $\frac{3}{8}$ " 2' 2 $\frac{5}{8}$ "	2' 3 $\frac{5}{8}$ " 2' 2 $\frac{3}{8}$ "	2' 3 $\frac{7}{8}$ " 2' 2 $\frac{1}{4}$ "	2' 4 $\frac{1}{4}$ " 2' 1 $\frac{3}{4}$ "	2' 4 $\frac{7}{8}$ " 2' 1 $\frac{3}{8}$ "	2' 5 $\frac{3}{4}$ " 2' 1 $\frac{1}{4}$ "
2	2' $\frac{1}{8}$ " 1'11 $\frac{7}{8}$ "	2' $\frac{1}{4}$ " 1'11 $\frac{3}{4}$ "	2' $\frac{1}{2}$ " 1'11 $\frac{5}{8}$ "	2' $\frac{3}{4}$ " 1'11 $\frac{3}{8}$ "	2' 1" 1'11 $\frac{1}{8}$ "	2' 1 $\frac{1}{2}$ " 1'10 $\frac{3}{4}$ "	2' 2" 1'10 $\frac{1}{4}$ "
1.75	1' 9 $\frac{1}{8}$ " 1' 8 $\frac{7}{8}$ "	1' 9 $\frac{1}{4}$ " 1' 8 $\frac{3}{4}$ "	1' 9 $\frac{1}{4}$ " 1' 8 $\frac{5}{8}$ "	1' 9 $\frac{1}{2}$ " 1' 8 $\frac{1}{2}$ "	1' 9 $\frac{5}{8}$ " 1' 8 $\frac{1}{4}$ "	1'10" 1' 8 $\frac{1}{8}$ "	1'10 $\frac{1}{2}$ " 1' 7 $\frac{7}{8}$ "

Depth-of-field table of MC Rokkor 55mm F1.7 Lens (in meters)

Dis (m) \ F No.	1.7	2.8	4	5.6	8	11	16
∞	∞ 53.4	∞ 32.5	∞ 23.0	∞ 16.3	∞ 11.5	∞ 8.2	∞ 5.8
10	12.3 8.4	14.4 7.7	17.6 7.0	25.6 6.2	72.6 5.4	∞ 4.5	∞ 3.7
5	5.5 4.6	5.9 4.4	6.3 4.1	7.1 3.9	8.7 3.5	12.5 3.1	33.9 2.7
3	3.17 2.85	3.29 2.76	3.43 2.67	3.64 2.55	4.00 2.41	4.64 2.22	6.01 2.01
2	2.07 1.93	2.12 1.89	2.18 1.85	2.26 1.80	2.39 1.72	2.59 1.63	2.96 1.52
1.5	1.54 1.46	1.57 1.44	1.59 1.42	1.64 1.39	1.70 1.34	1.80 1.29	1.97 1.22
1.2	1.22 1.18	1.24 1.16	1.26 1.15	1.28 1.13	1.32 1.10	1.38 1.06	1.47 1.02
1	1.02 0.98	1.03 0.98	1.04 0.96	1.06 0.95	1.08 0.93	1.12 0.91	1.18 0.87
0.9	0.91 0.89	0.92 0.88	0.93 0.87	0.94 0.86	0.96 0.85	0.99 0.82	1.04 0.80
0.8	0.81 0.79	0.82 0.78	0.82 0.78	0.83 0.77	0.85 0.76	0.87 0.74	0.90 0.72
0.7	0.71 0.69	0.71 0.69	0.72 0.68	0.73 0.68	0.74 0.67	0.75 0.66	0.77 0.64
0.6	0.61 0.60	0.61 0.59	0.61 0.59	0.62 0.58	0.62 0.58	0.64 0.57	0.65 0.56
0.55	0.55 0.55	0.56 0.54	0.56 0.54	0.56 0.54	0.57 0.53	0.58 0.53	0.59 0.52

Checking the effects of depth of field

MC Rokkor Lenses are designed with a meter coupler which permits them to remain wide open during viewing, focusing, and exposure setting. In order to check your depth of field visually when using these lenses push the diaphragm stop-down button on the camera body after the aperture has been set.

When using other Rokkor Lenses designed for the Minolta SR-1, SR-3 or SR-7, use the preview button on the lens barrel or the camera's diaphragm button.

- When the diaphragm stop-down button is pushed, after you advance the film, the diaphragm closes down to the preset aperture and locks. When the button is pressed again, the diaphragm reopens fully.

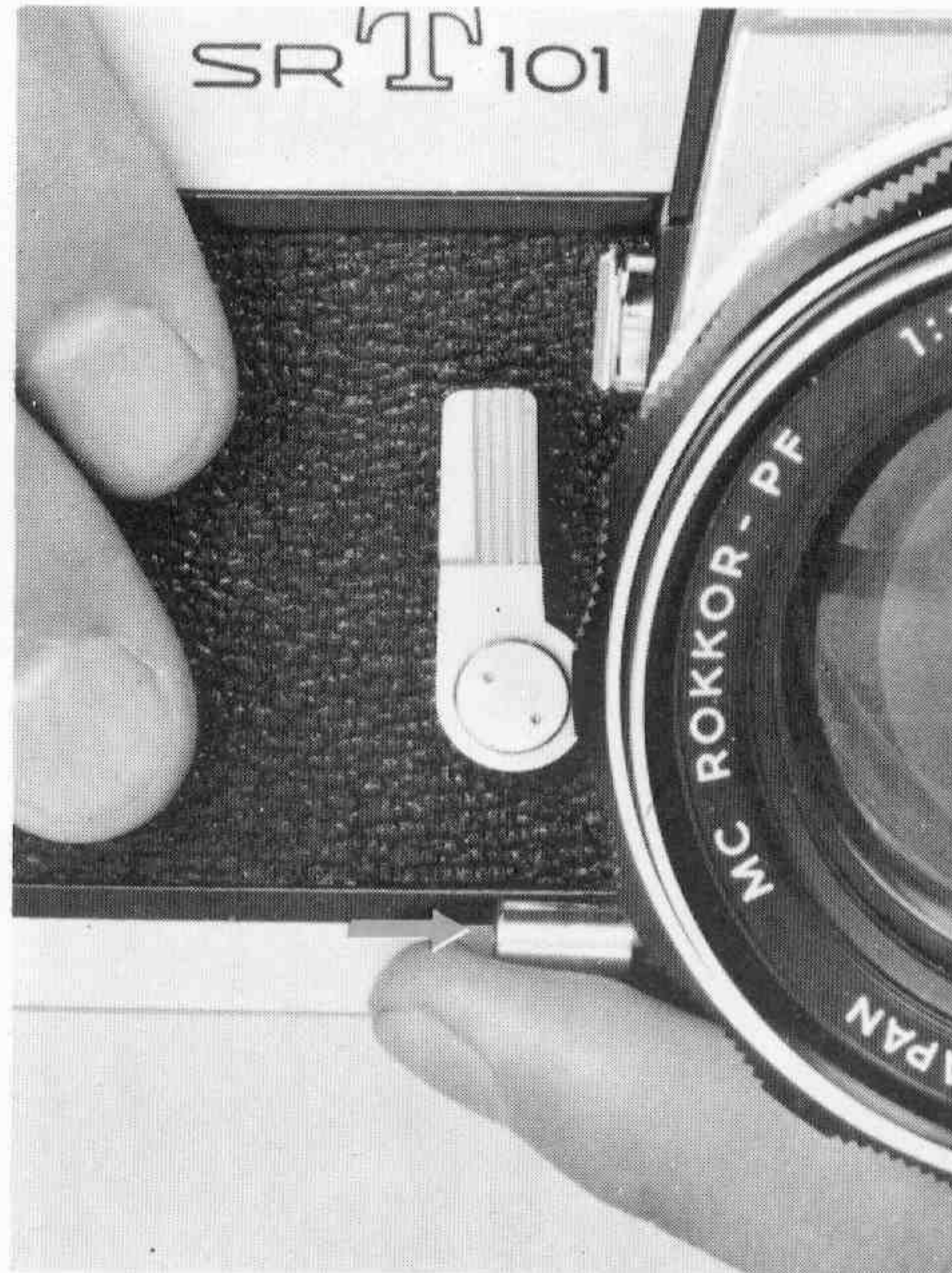

Mirror lock-up control

The mirror lock-up control is used in conjunction with the Rokkor 21mm ultra wideangle lens. When activated, the mirror is locked in an "up" position to prevent it from coming into contact with the rear element of the lens which projects into the interior of the camera.

To operate, turn the mirror lock button downward (clockwise) until it stops. The distance of movement is approximately 135° .

The mirror will return to its usual operation when the lock button is returned to the red mark.

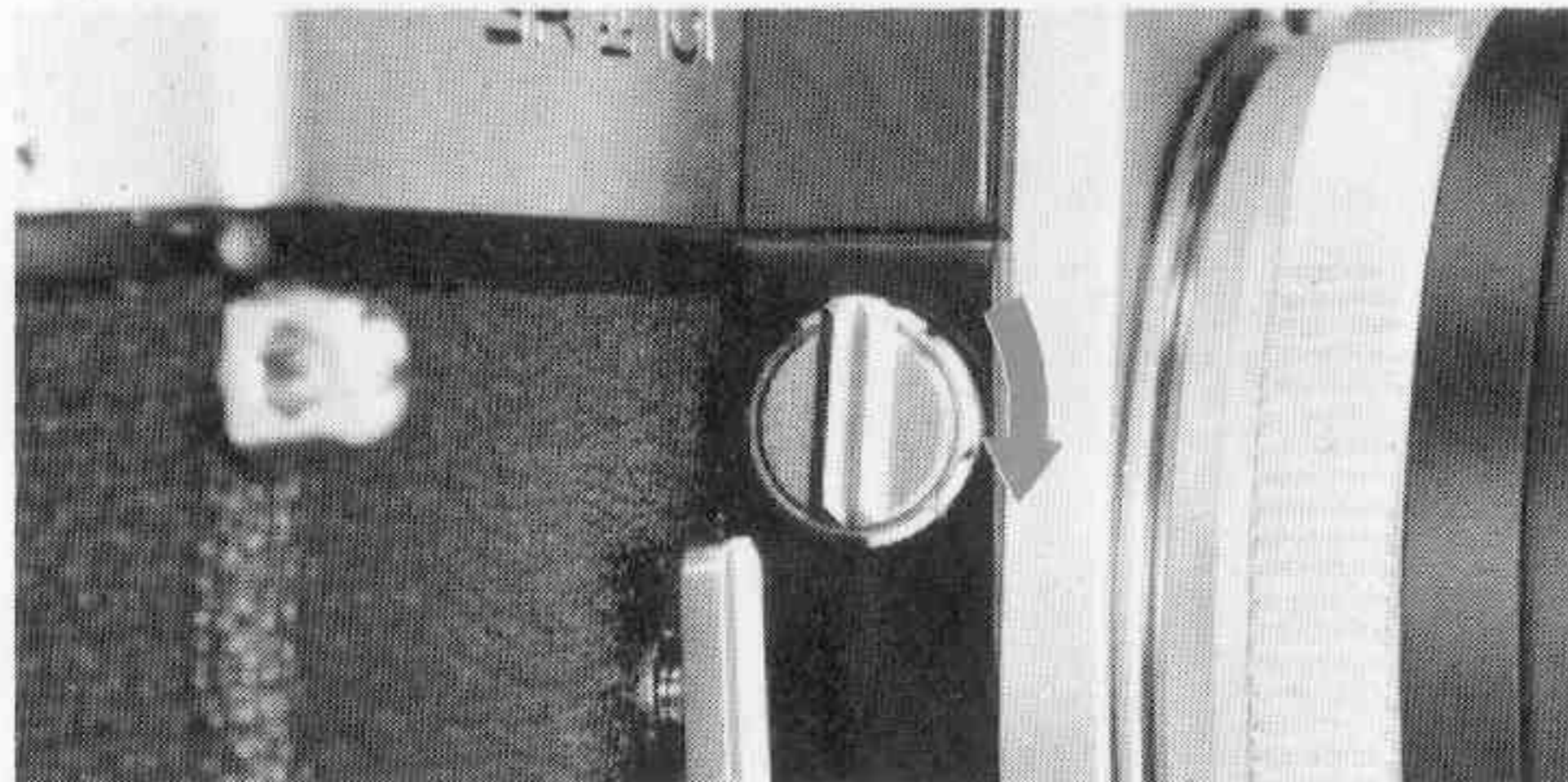

The mirror lock button operates independently of the shutter release and film advance and can, therefore, be activated at any time.

The mirror lock-up system is also helpful for photomicrography, sequence, and close-up photography, as it eliminates the possibility of camera motion caused by the movement of the mirror when the shutter is released.

- When the mirror is locked in an "up" position, the exposure meter of the camera cannot operate, and an independent meter must be used.

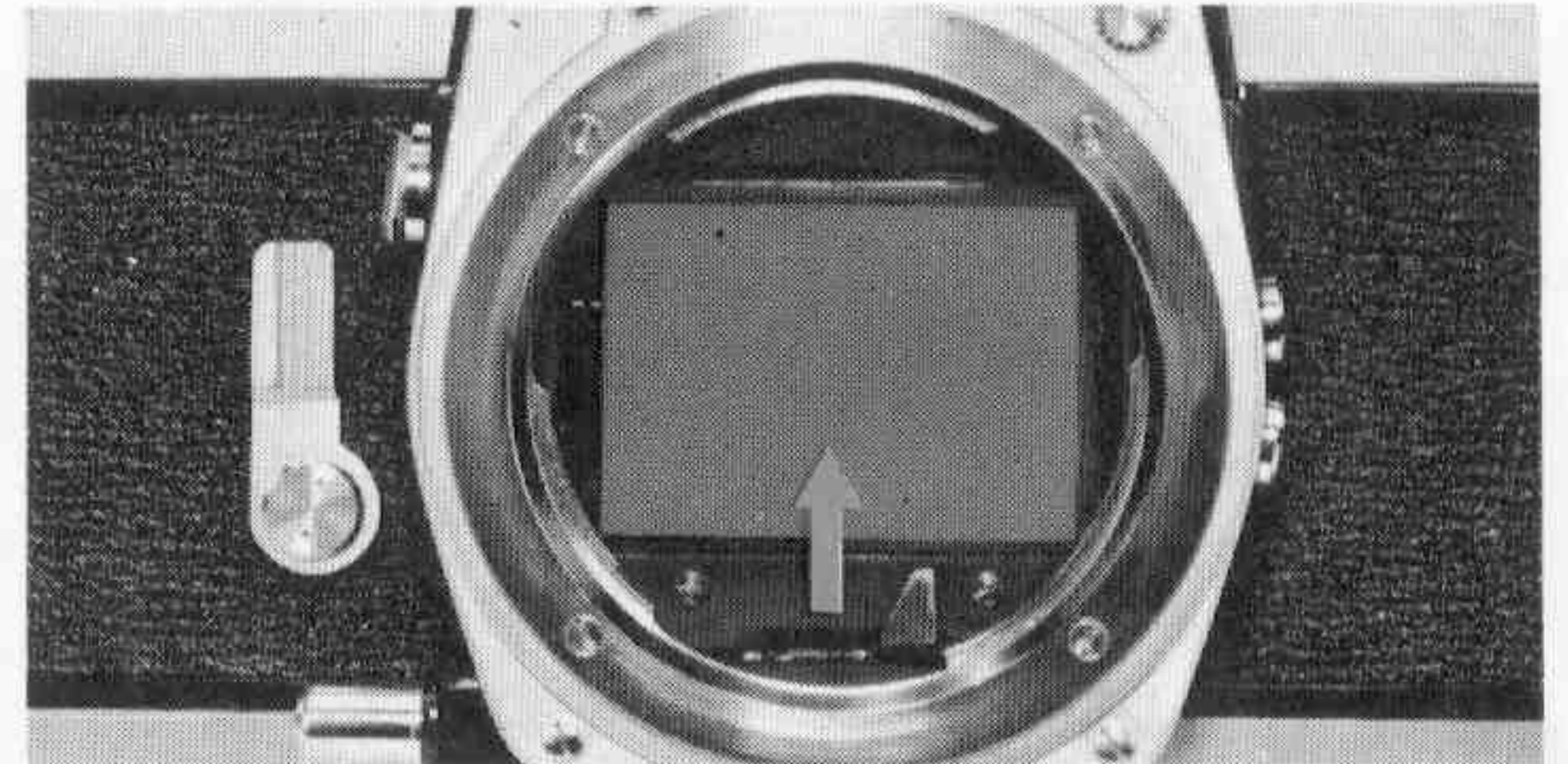

Self-timer

The self-timer delays shutter release about 10 seconds from the time you press the self-timer release button. This allows time for you to get into the picture.

To operate, advance the film (this will automatically cock the shutter). Next, push the self-timer lever down (about 90°) and then press the self-timer release button. The self-timer is now operating, and the shutter will automatically be released after about 10 seconds.

NOTE:

- If the film has not been advanced, the self-timer lever will stop after returning about 45° and the shutter will not be released.
- You can override the self-timer mechanism by pushing the shutter release button either before or after the self-timer has been activated.



Infrared index

When using infrared film it is necessary to make an "infrared focus adjustment." After you have made your normal focusing adjustment, turn the focusing ring to the right to align the distance on the focusing scale with the red "R" mark on the depth-of-field scale. After this adjustment has been made you are ready to shoot.

- To determine correct exposure for infrared photography, consult the instructions enclosed in the film package.

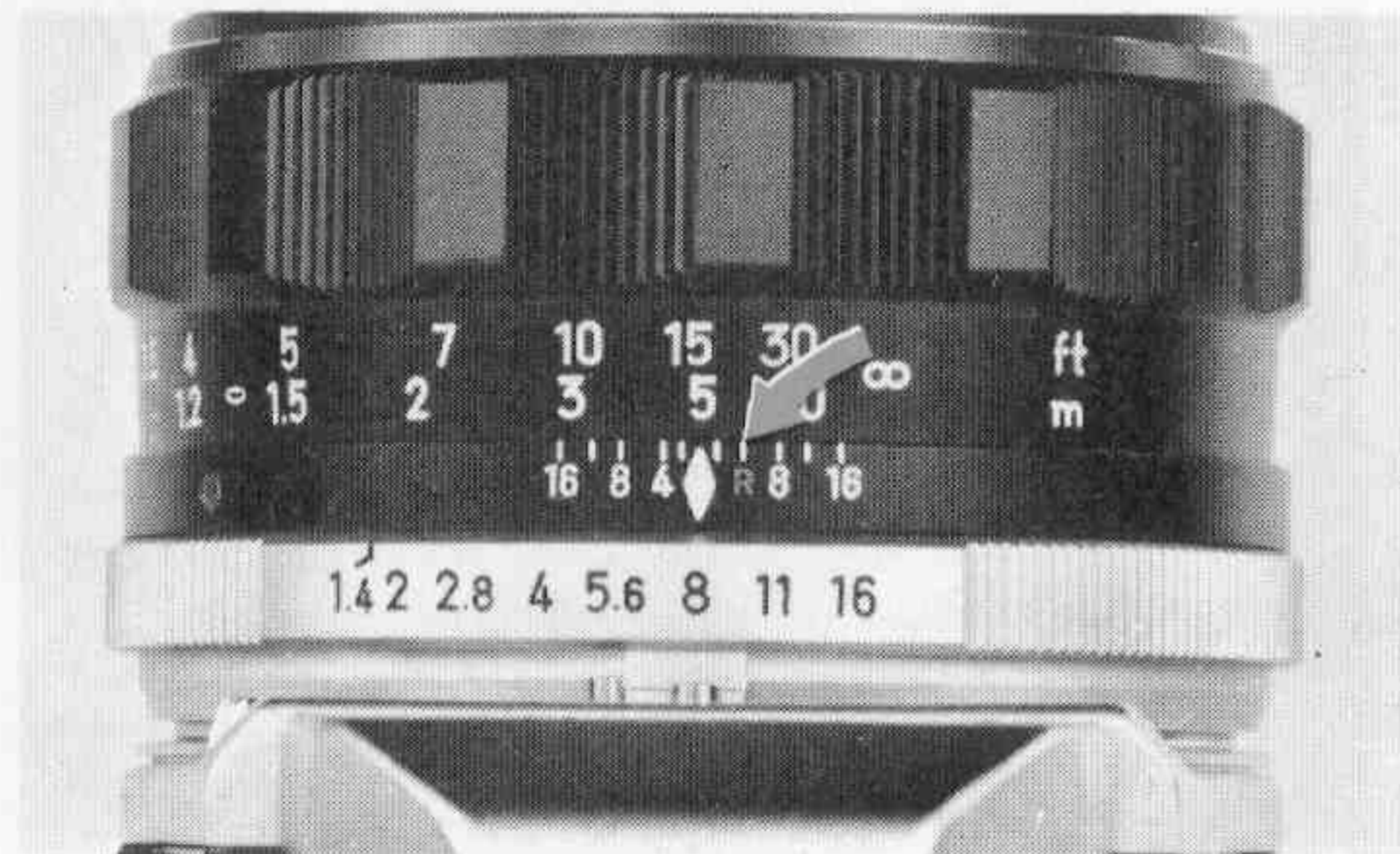

Film plane index

The ϕ symbol engraved to the left of the film advance lever shows the exact position of the film in the camera. It is used to precisely measure the distance from subject to film for close-up photography and photomacrography.

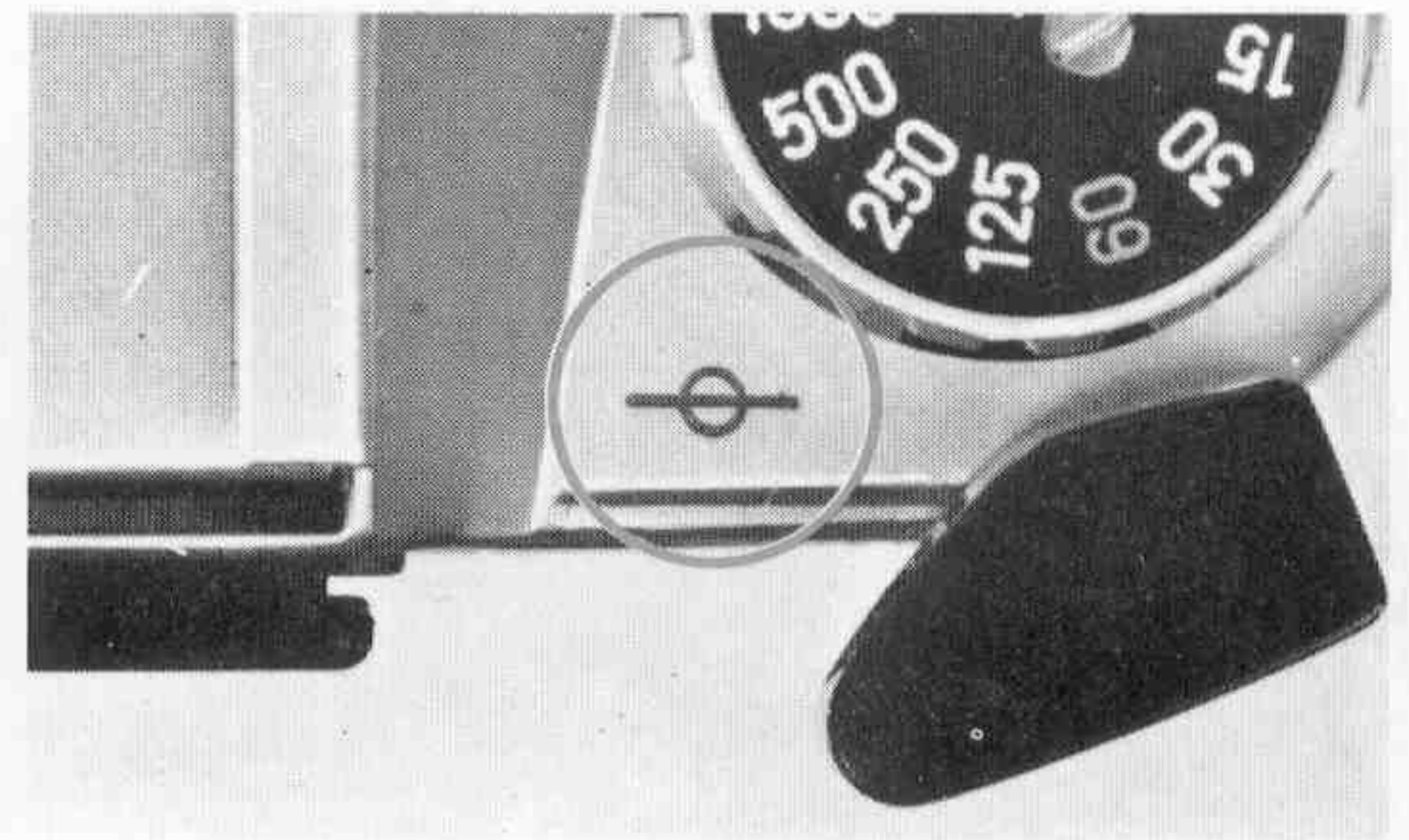

UNLOADING EXPOSED FILM

1. To rewind the film, depress the rewind button on the base of the camera. The button should remain depressed when you remove your finger. (If, however, it returns to its locked position, rewind the film for approximately 2 revolutions while depressing the button. Then actuate the film advance lever one full stroke without depressing the button and depress it again. This should lock button in the depressed position.)

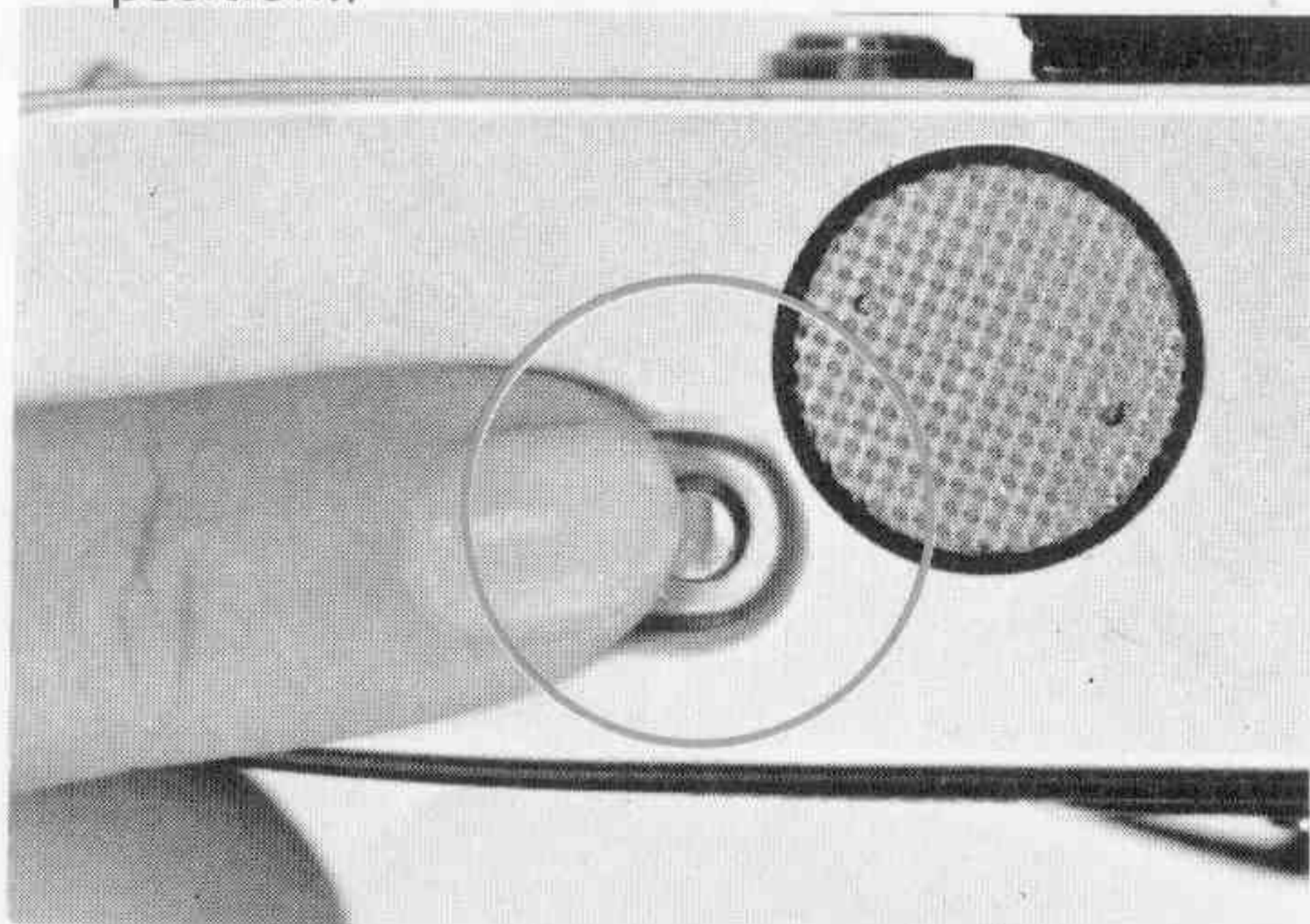

2. Lift the rewind crank and turn it clockwise. This will rewind the film into the magazine. When you feel a slight resistance, you have rewound nearly all the film and it has disengaged from the take-up spool. After one or two more turns you can assume all the film has been rewound into the magazine.



3. Now, pull the back cover release knob out to open the camera back and remove the film magazine.

NOTE:

- The film rewind release button will automatically return to its original position as the film advance lever is activated.

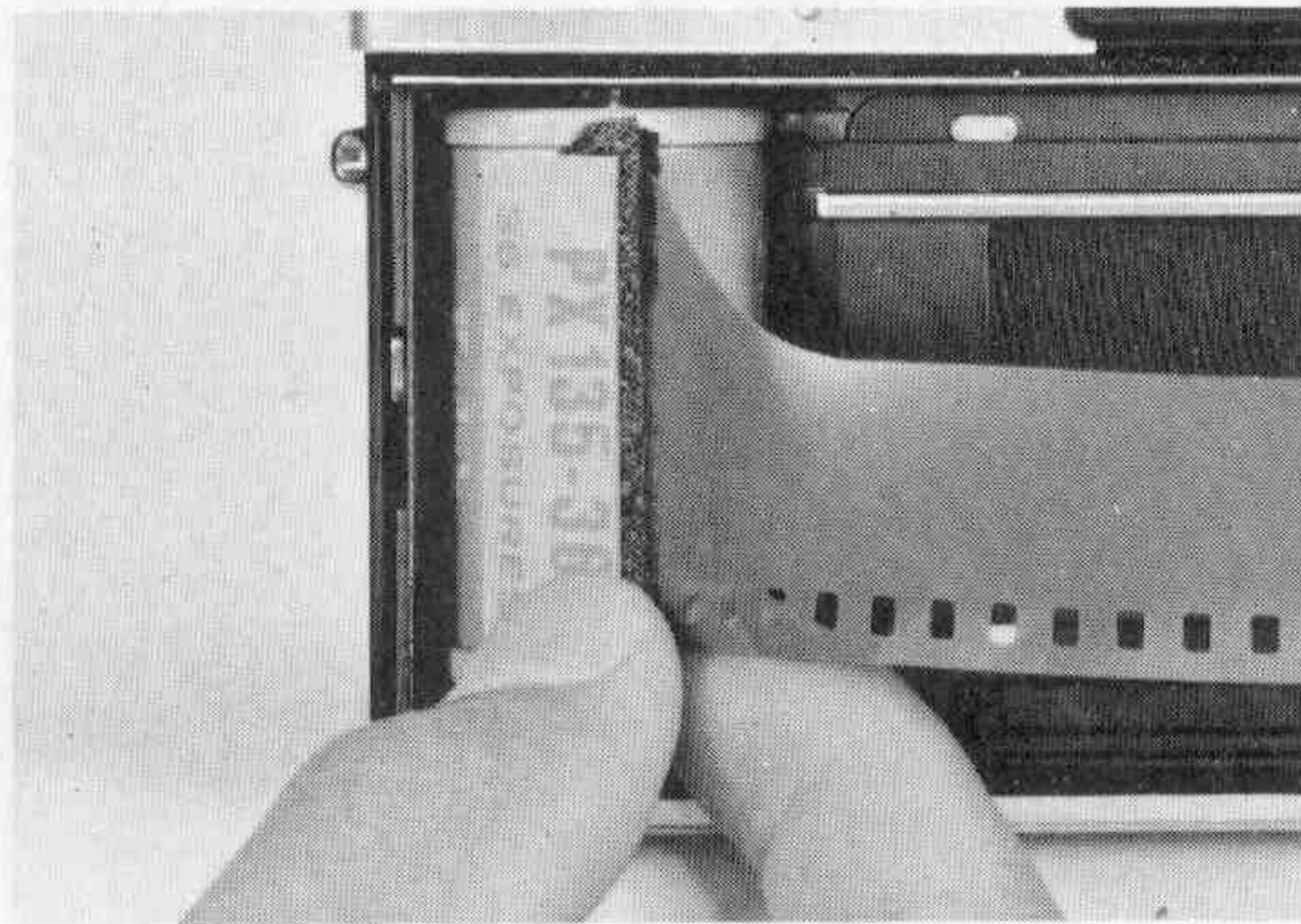

CHANGING LENSES

Lenses can be changed even when the film has been advanced and the shutter locked. To remove the mounted lens, push the lens release button down and rotate the lens counterclockwise until it stops. It can now be lifted out.



To mount a lens, insert it into the bayonet socket by lining up the red dot on the lens barrel with the red dot on the camera body. Now, turn the lens clockwise until it stops with a "click."

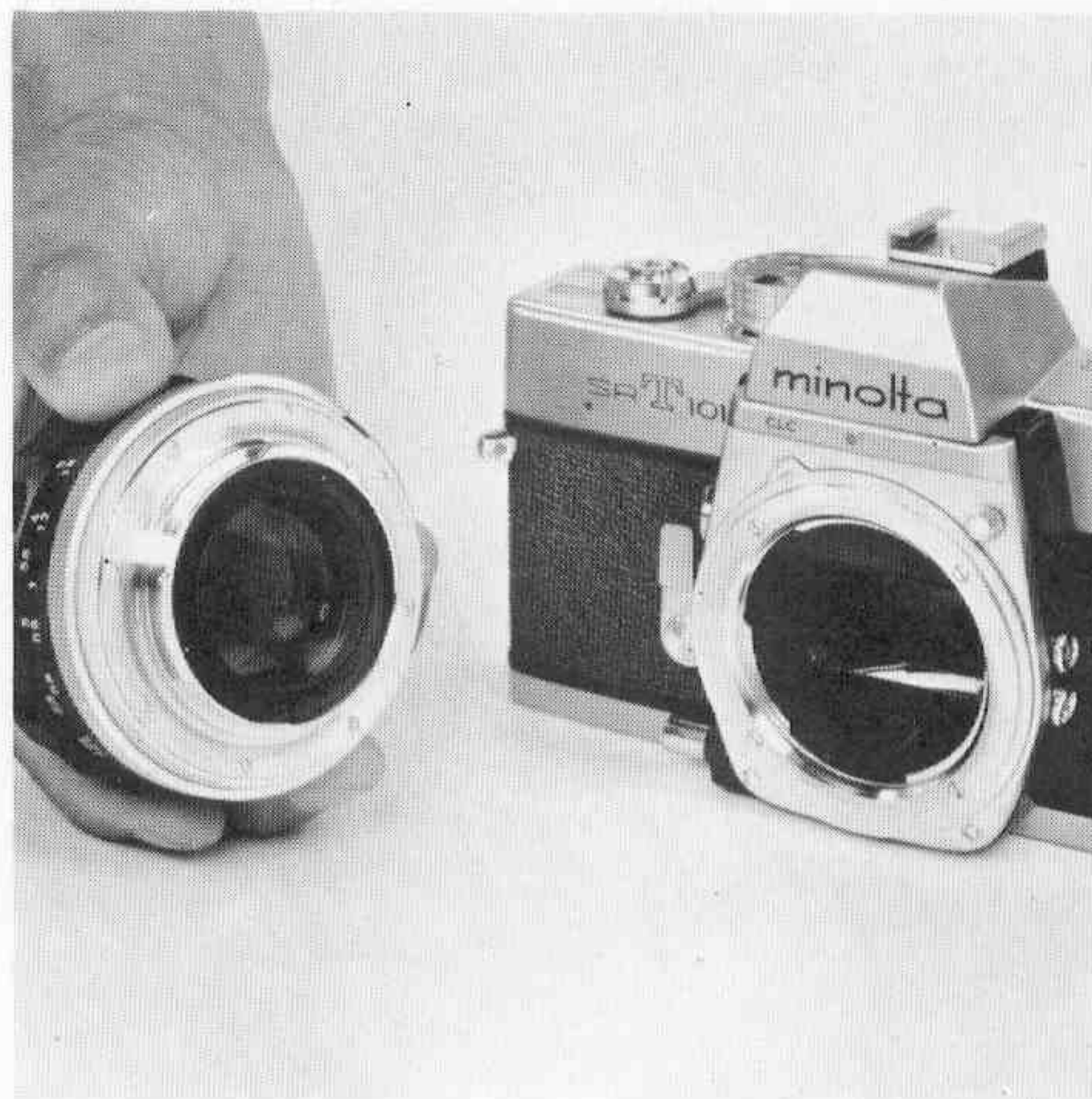

CAUTION:

- Touch nothing inside the bayonet mount while lens is removed.
- If the lens is left removed, replace it with a body cap to prevent dust from collecting on the mirror and shutter mechanisms.

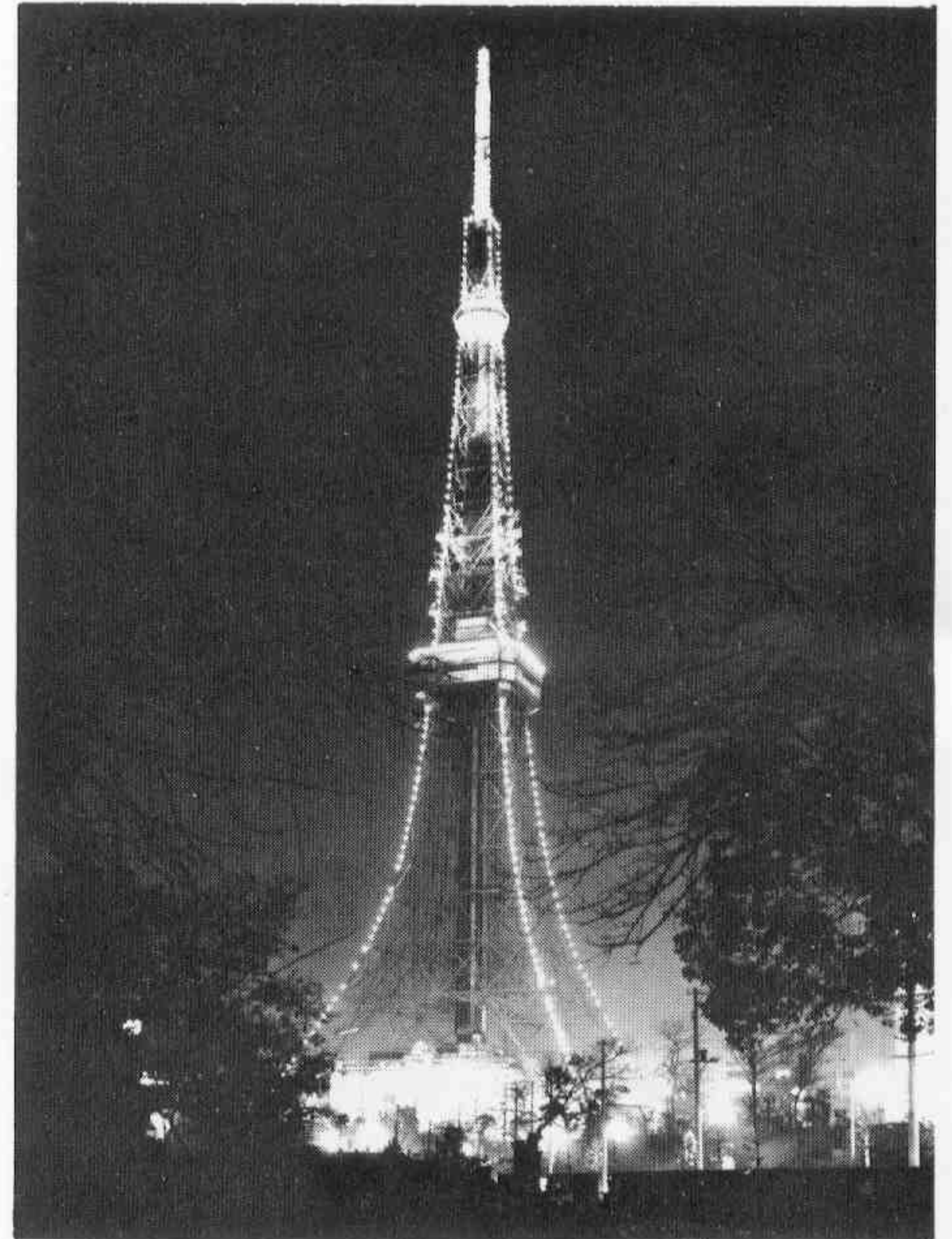

USING INTERCHANGEABLE ROKKOR LENSES OTHER THAN MC LENSES

When using Rokkor Lenses designed for the Minolta SR-1, SR-3 or SR-7, which do not have a meter coupling pin, you must use the "stop-down measurement system" to set exposure.

With this system the indicator needle moves when the lens diaphragm is opened or closed and the follow-up (circle-tipped) needle is activated by the shutter-speed dial.

Auto Rokkor Lenses

- 1) Advance the film.
- 2) Press the diaphragm stop-down button (it will remain depressed).
- 3) Set the shutter speed.
- 4) Turn the diaphragm ring until the two needles are aligned. (The diaphragm can be set first.)
- 5) Press the diaphragm stop-down button again.
- 6) Focus and shoot.

- The diaphragm stop-down button will not operate if the film advance lever has not been advanced completely.
- When the diaphragm stop-down button is pressed the second time, the diaphragm reopens to maximum aperture.
- When the shutter is released, the diaphragm automatically closes down to the preset aperture and reopens.



Manual preset Rokkor Lenses

- 1) Set the shutter speed.
- 2) Set the maximum aperture of the lens, then close down until the two needles are aligned.
- 3) Release the shutter.



- It is not necessary to use the diaphragm stop-down button, with manual preset lenses.
- Compose and focus your picture before making your exposure setting.
- If you focus or compose your picture after making your exposure setting, and you do this by opening the lens to maximum aperture, be sure to close it down again to the proper point before you shoot.

NOTE:

- The indicator needle moves when the aperture is adjusted.
- The follow-up needle moves when the shutter speed is adjusted.

CARE AND STORAGE OF YOUR MINOLTA SR-T 101

Do not touch the lens. If it becomes dirty, use a rubber ball blower to blow dust off its surface, then gently wipe its surface from the center outward with a lens cleaning cloth or tissue.

- Try to keep the lens clean. Brush it with a soft brush from time to time.
- Do not touch the mirror, but dust it with a soft brush.
- External camera surfaces may be cleaned with a silicon cloth.
- When storing the camera, set the distance scale to ∞ , release the shutter, and put the camera in its leather case.
- Do not drop or jar the camera.
- Do not store the camera in high temperature or humidity.
- When leaving the camera unused for a long time, remove the mercury battery from it.
- When storing the camera for a long period of time, put in original packaging with a small bag of drying agent, such as silica gel.

CAUTION:

- *Lens cleaning fluid should be used only when fingerprints or scum formation cannot be removed with lens tissue.*

In this case, use one drop only of lens cleaner on lens cleaning paper or a soft cloth and wipe the lens gently from its center toward the edge. Be sure not to drop the fluid directly on the lens.

We hope that you'll enjoy your Minolta camera.

If you have any questions, ask your Minolta dealer. He is knowledgeable in all aspects of photography, and he can help you with all of your photographic needs.

Minolta Camera Co., Ltd., 18, 4-chome, Shio-machidori, Minami-ku, Osaka, Japan

Minolta Corporation, 200 Park Avenue South
New York, N.Y. 10003, U.S.A.

Minolta Camera Handelsgesellschaft m.b.H., 2
Hamburg 1, Spaldingstrasse 1, West Germany

Minolta

MINOLTA MASTERS PHOTOGRAPHY