

Nikon

En

The Nikon Guide to Digital Photography
with the

D40

DIGITAL CAMERA

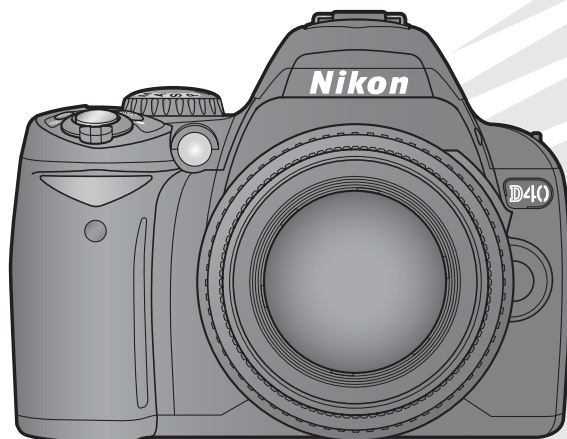



CE

Where to Find It



Find what you're looking for from:

 **The *Table of Contents***  **See pages v–vi**
Find items by function or menu name.

 **The *Q&A Index***  **See pages vii–ix**
Know what you want to do but don't know the function name? Find it from the "question and answer" index.

 **The *Index***  **See pages 123–125**
Search by key word.

 **Error Messages**  **See pages 111–112**
If a warning is displayed in the viewfinder or monitor, find the solution here.

 **Troubleshooting**  **See pages 108–110**
Camera behaving unexpectedly? Find the solution here.

Help

Use the camera's on-board help feature for help on menu items and other topics. See page 3 for details.

Digitutor

Digitutor, a series of "watch and learn" manuals in movie form, is available from the following website:
http://www.nikondigitutor.com/index_eng.html

Introduction



Tutorial

Photography and Playback



Reference

More on Photography (All Modes)



P, S, A, and M Modes



More on Playback



Connecting to a Computer, Printer, or TV



Menu Guide

Playback Options: The Playback Menu



Shooting Options: The Shooting Menu



Custom Settings



Basic Camera Settings: The Setup Menu



Creating Retouched Copies: The Retouch Menu



Technical Notes



For Your Safety

To prevent damage to your Nikon product or injury to yourself or to others, read the following safety precautions in their entirety before using this equipment. Keep these safety instructions where all those who use the product will read them.

The consequences that could result from failure to observe the precautions listed in this section are indicated by the following symbol:



This icon marks warnings. To prevent possible injury, read all warnings before using this Nikon product.

WARNINGS

-  **Do not look at the sun through the viewfinder**
Viewing the sun or other strong light source through the viewfinder could cause permanent visual impairment.
-  **Using the viewfinder diopter control**
When operating the viewfinder diopter control with your eye to the viewfinder, care should be taken not to put your finger in your eye accidentally.
-  **Turn off immediately in the event of malfunction**
Should you notice smoke or an unusual smell coming from the equipment or AC adapter (available separately), unplug the AC adapter and remove the battery immediately, taking care to avoid burns. Continued operation could result in injury. After removing the battery, take the equipment to a Nikon-authorized service center for inspection.
-  **Do not disassemble**
Touching the product's internal parts could result in injury. In the event of malfunction, the product should be repaired only by a qualified technician. Should the product break open as the result of a fall or other accident, remove the battery and/or AC adapter and then take the product to a Nikon-authorized service center for inspection.
-  **Do not use in the presence of flammable gas**
Do not use electronic equipment in the presence of flammable gas, as this could result in explosion or fire.
-  **Keep out of reach of children**
Failure to observe this precaution could result in injury.
-  **Do not place the strap around the neck of an infant or child**
Placing the camera strap around the neck of an infant or child could result in strangulation.
-  **Observe proper precautions when handling batteries**
Batteries may leak or explode if improperly handled. Observe the following precautions when handling batteries for use in this product:
 - Use only batteries approved for use in this equipment.
 - Do not short or disassemble the battery.
 - Be sure the product is off before replacing the battery. If you are using an AC adapter, be sure it is unplugged.
- Do not attempt to insert the battery upside down or backwards.
- Do not expose the battery to flame or to excessive heat.
- Do not immerse in or expose to water.
- Replace the terminal cover when transporting the battery. Do not transport or store the battery with metal objects such as necklaces or hairpins.
- Batteries are prone to leakage when fully discharged. To avoid damage to the product, be sure to remove the battery when no charge remains.
- When the battery is not in use, attach the terminal cover and store in a cool, dry place.
- The battery may be hot immediately after use or when the product has been used on battery power for an extended period. Before removing the battery turn the camera off and allow the battery to cool.
- Discontinue use immediately should you notice any changes in the battery, such as discoloration or deformation.
-  **Observe proper precautions when handling the quick charger**
 - Keep dry. Failure to observe this precaution could result in fire or electric shock.
 - Dust on or near the metal parts of the plug should be removed with a dry cloth. Continued use could result in fire.
 - Do not handle the power cable or go near the charger during thunderstorms. Failure to observe this precaution could result in electric shock.
 - Do not damage, modify, or forcibly tug or bend the power cable. Do not place it under heavy objects or expose it to heat or flame. Should the insulation be damaged and the wires become exposed, take the power cable to a Nikon-authorized service representative for inspection. Failure to observe this precaution could result in fire or electric shock.
 - Do not handle the plug or charger with wet hands. Failure to observe this precaution could result in electric shock.

Use appropriate cables

When connecting cables to the input and output jacks, use only the cables provided or sold by Nikon for the purpose to maintain compliance with product regulations.

CD-ROMs

CD-ROMs containing software or manuals should not be played back on audio CD equipment. Playing CD-ROMs on an audio CD player could cause hearing loss or damage the equipment.

Avoid contact with liquid crystal

Should the monitor break, care should be taken to avoid injury due to broken glass and to prevent the liquid crystal from the monitor touching the skin or entering the eyes or mouth.

Observe caution when using the flash

Do not operate the flash with the flash window touching a person or object. Failure to observe this precaution could result in burns or fire.

Using the flash close to the subject's eyes could cause temporary visual impairment. Particular care should be observed when photographing infants, when the flash should be no less than one meter (39in.) from the subject.

Notices

- No part of the manuals included with this product may be reproduced, transmitted, transcribed, stored in a retrieval system, or translated into any language in any form, by any means, without Nikon's prior written permission.
- Nikon reserves the right to change the specifications of the hardware and software described in these manuals at any time and without prior notice.
- Nikon will not be held liable for any damages resulting from the use of this product.
- While every effort has been made to ensure that the information in these manuals is accurate and complete, we would appreciate it were you to bring any errors or omissions to the attention of the Nikon representative in your area (address provided separately).

Notices for Customers in the U.S.A.

Federal Communications Commission (FCC) Radio Frequency Interference Statement

This equipment has been tested and found to comply with the limits for a Class B digital device, pursuant to Part 15 of the FCC rules. These limits are designed to provide reasonable protection against harmful interference in a residential installation. This equipment generates, uses, and can radiate radio frequency energy and, if not installed and used in accordance with the instructions, may cause harmful interference to radio communications. However, there is no guarantee that interference will not occur in a particular installation. If this equipment does cause harmful interference to radio or television reception, which can be determined by turning the equipment off and on, the user is encouraged to try to correct the interference by one or more of the following measures:

- Reorient or relocate the receiving antenna.
- Increase the separation between the equipment and receiver.
- Connect the equipment into an outlet on a circuit different from that to which the receiver is connected.
- Consult the dealer or an experienced radio/television technician for help.



CAUTIONS

Modifications

The FCC requires the user be notified that any changes or modifications made to this device that are not expressly approved by Nikon Corporation may void the user's authority to operate the equipment.

Interface Cables

Use the interface cables sold or provided by Nikon for your equipment. Using other interface cables may exceed the limits of Class B Part 15 of the FCC rules.

Notice for Customers in the State of California

WARNING: Handling the cord on this product may expose you to lead, a chemical known to the State of California to cause birth defects or other reproductive harm. *Wash hands after handling.*

Nikon Inc., 1300 Walt Whitman Road, Melville, New York 11747-3064, U.S.A.

Tel.: 631-547-4200

Notices for Customers in Canada

CAUTION

This class B digital apparatus meets all requirements of the Canadian Interference Causing Equipment Regulations.

ATTENTION

Cet appareil numérique de la classe B respecte toutes les exigences du Règlement sur le matériel brouilleur du Canada.

Symbol for Separate Collection in European Countries

This symbol indicates that this product is to be collected separately.



The following apply only to users in European countries:

- This product is designated for separate collection at an appropriate collection point. Do not dispose of as household waste.
- For more information, contact the retailer or the local authorities in charge of waste management.

Notice Concerning Prohibition of Copying or Reproduction

Note that simply being in possession of material that has been digitally copied or reproduced by means of a scanner, digital camera, or other device may be punishable by law.

• Items prohibited by law from being copied or reproduced

Do not copy or reproduce paper money, coins, securities, government bonds, or local government bonds, even if such copies or reproductions are stamped "Sample."

The copying or reproduction of paper money, coins, or securities which are circulated in a foreign country is prohibited.

Unless the prior permission of the government has been obtained, the copying or reproduction or unused postage stamps or post cards issued by the government is prohibited.

The copying or reproduction of stamps issued by the government and of certified documents stipulated by law is prohibited.

• Cautions on certain copies and reproductions

The government has issued cautions on copies or reproductions of securities issued by private companies (shares, bills, checks, gift certificates, etc.), commuter passes, or coupon tickets, except when a minimum of necessary copies are to be provided for business use by a company. Also, do not copy or reproduce passports issued by the government, licenses issued by public agencies and private groups, ID cards, and tickets, such as passes and meal coupons.

• Comply with copyright notices

The copying or reproduction of copyrighted creative works such as books, music, paintings, woodcuts, prints, maps, drawings, movies, and photographs is governed by national and international copyright laws. Do not use this product for the purpose of making illegal copies or to infringe copyright laws.

Disposing of Data Storage Devices



Please note that deleting images or formatting memory cards or other data storage devices does not completely erase the original image data. Deleted files can sometimes be recovered from discarded storage devices using commercially available software, potentially resulting in the malicious use of personal image data. Ensuring the privacy of such data is the user's responsibility.

Before discarding a data storage device or transferring ownership to another person, erase all data using commercial deletion software, or format the device and then completely refill it with images containing no private information (for example, pictures of empty sky). Be sure to also replace any pictures selected for preset white balance and for **Display format > Wallpaper**. Care should be taken to avoid injury when physically destroying data storage devices.

Trademark Information

Macintosh, Mac OS, and QuickTime are registered trademarks of Apple Computer, Inc. Microsoft and Windows are registered trademarks of Microsoft corporation. The SD logo is a trademark of the SD Card Association. The SDHC logo is a trademark. Adobe, Acrobat, and Adobe Reader are registered trademarks of Adobe Systems Inc. PictBridge is a trademark. All other trade names mentioned in this manual or the other documentation provided with your Nikon product are trademarks or registered trademarks of their respective holders.

Table of Contents

For Your Safety.....	ii	Connecting to a Computer, Printer, or TV	55
Notices.....	iii	Connecting to a Computer	55
Q&A Index	vii	Before Connecting the Camera.....	55
		Connecting the USB Cable.....	55
Introduction	1	Printing Photographs.....	57
Getting to Know the Camera	2	Printing Via Direct USB Connection	57
First Steps.....	8	Viewing Photographs on TV.....	62
Attaching a Lens.....	8		
Charging and Inserting the Battery	9	Menu Guide.....	63
Basic Setup.....	11	Using Camera Menus	63
Inserting Memory Cards.....	12	Playback Options: The Playback Menu	65
Adjusting Viewfinder Focus.....	14	Delete.....	65
		Playback Folder.....	66
Tutorial	15	Rotate Tall.....	66
“Point-and-Shoot” Photography (AUTO Mode).....	15	Slide Show.....	67
Creative Photography (Digital Vari-Programs).....	18	Print Set (DPOF).....	67
Basic Playback.....	20	Shooting Options: The Shooting Menu	68
		Optimize Image (P, S, A, and M Modes)	68
Reference.....	21	Image Quality	70
More on Photography (All Modes)	22	Image Size.....	70
The Shooting Information Display	22	White Balance (P, S, A, and M Modes)	70
Focus.....	23	ISO Sensitivity.....	73
Focus Mode.....	23	Noise Reduction.....	73
AF-Area Mode.....	24	Custom Settings.....	74
Focus Area Selection.....	25	R: Reset.....	74
Focus Lock.....	26	1: Beep.....	74
Manual Focus	28	2: Focus Mode	75
Image Quality and Size.....	29	3: AF-Area Mode.....	75
Image Quality.....	30	4: Shooting Mode.....	75
Image Size	30	5: Metering (P, S, A, and M Modes Only).....	75
Shooting Mode	32	6: No Memory Card?.....	75
Self-Timer and Remote Control Modes.....	33	7: Image Review	75
Using the Built-in Flash.....	34	8: Flash Level (P, S, A, and M Modes Only).....	76
ISO Sensitivity	37	9: AF-Assist (All Modes Except  and ).....	76
Two-Button Reset.....	38	10: ISO Auto (P, S, A, and M Modes Only).....	76
P, S, A, and M Modes.....	39	11:  /Fn Button.....	77
Mode P (Programmed Auto)	40	12: AE-L/AF-L.....	77
Mode S (Shutter-Priority Auto)	41	13: AE Lock.....	77
Mode A (Aperture-Priority Auto)	42	14: Built-in Flash (P, S, A, and M Modes Only).....	78
Mode M (Manual)	43	15: Auto off Timers.....	78
Exposure	45	16: Self-Timer	79
Metering.....	45	17: Remote on Duration.....	79
Autoexposure Lock.....	46	Basic Camera Settings: The Setup Menu	80
Exposure Compensation.....	47	CSM/Setup Menu	80
Flash Compensation	48	Format Memory Card.....	81
White Balance	49	Info Display Format	81
		Auto Shooting Info	83
More on Playback	50	World Time	83
Viewing Photographs on the Camera.....	50	LCD Brightness.....	83
Photo Information.....	51	Video Mode.....	83
Viewing Multiple Images: Thumbnail Playback	52	Language (LANG).....	84
Taking a Closer Look: Playback Zoom	53	Image Comment	84
Protecting Photographs from Deletion	54	USB.....	84
Deleting Individual Photographs.....	54		

Folders.....	85	Technical Notes	96
File No. Sequence	86	Optional Accessories.....	96
Mirror Lock-Up.....	86	Lenses.....	97
Firmware Version.....	86	Optional Flash Units (Speedlights)	99
Dust off Ref Photo.....	87	Other Accessories.....	102
Auto Image Rotation	88	Accessories for the D40	103
Creating Retouched Copies: The Retouch Menu	89	Caring for the Camera.....	104
D-Lighting	90	Caring for the Camera and Battery: Cautions	106
Red-Eye Correction	91	Troubleshooting	108
Trim	91	Camera Error Messages and Displays	111
Monochrome.....	92	Appendix.....	113
Filter Effects.....	92	Specifications.....	119
Small Picture.....	92	Index	123
Image Overlay.....	94		

Q&A Index

Find what you're looking for using this "question and answer" index.

General Questions

Question	Key phrase	Page #
How do I use the menus?	Using the menus	63–64
How do I get more information on a menu?	Help	3
What do these indicators mean?	Monitor, viewfinder	5–6, 81–82
What does this warning mean?	Error messages and displays	111–112
How many more shots can I take with this card?	Number of exposures remaining	29, 116
How much charge does the battery have left?	Battery level	15
What does "exposure" mean and how does it work?	Exposure	39
What do I do with the viewfinder eyepiece cap?	Self timer, remote control	33
What optional flash units (Speedlights) can I use?	Optional flash units	99
What lenses can I use?	Lenses	97
What accessories are available for my camera?	Accessories for the D40	96
What memory cards can I use?	Approved memory cards	102
What software is available for my camera?	Accessories for the D40	103
Who can I ask to repair or inspect my camera?	Servicing the camera	x
How do I clean the camera or lens?	Cleaning the camera	104

Camera Setup

Question	Key phrase	Page #
How do I focus the viewfinder?	Viewfinder focus	14
How do I keep the monitor from turning off?	Stand-by mode	78
How do I set the clock?	World time	11, 83
How do I set the clock for daylight savings time?		
How do I change time zones when I travel?		
How do I adjust monitor brightness?	LCD brightness	83
How do I restore default settings?	Two-button reset	38
How do I turn off the light on the front of the camera?	AF-assist illuminator	76
How do I keep the shutter speed and aperture displays from turning off?	Stand-by mode	78
How do I change the self timer delay?	Self timer	33
How do I change the remote delay?	Remote control	33
How do I keep the camera from beeping?	Beep	74
How do I view all the items in the menus?	CSM/setup menu	80
Can I display the menus in a different language?	Language	84
How do I keep the file number from being reset when I insert a new memory card?	File number sequence	86
How can I prevent the same file name from being assigned to different photographs?		

Taking Photographs

Question	Key phrase	Page #
Is there an easy way to take snapshots?	Auto mode	15
Is there an easy way to take more creative shots?	Digital Vari-Program modes	18
What do I do if flash photography is prohibited?	Auto (flash off) mode	
How do I bring out a portrait subject?	Portrait mode	
How can I get good landscape shots?	Landscape mode	
How do I take snapshots of my kids?	Child mode	19
How do I "freeze" a moving subject?	Sports mode	
How do I take close ups of small objects?	Close-up mode	
Can I include night backgrounds in my portraits?	Night portrait mode	
How do I change camera settings using the shooting information display?	Shooting information display	22
How do I take a lot of photographs quickly?	Shooting mode	32
Can I shoot a self-portrait?		33
Is there a remote control for this camera?		33
How do I adjust exposure?	Exposure; P , S , A , and M modes	39
How do I freeze or blur moving objects?	Mode S (shutter-priority auto)	41
How do I blur background details?	Mode A (aperture-priority auto)	42
Can I make photos brighter or darker?	Exposure compensation	47
How do I make a time exposure?	Long time-exposures	44
How do I use the flash?	Flash photography, flash mode	34
Can the flash fire automatically when needed?		
How do I keep the flash from firing?		
How do I prevent red eye?	Red-eye reduction	35
Can I take pictures under low light without the flash?	ISO sensitivity	37
Can I control how the camera focuses?	Autofocus	23
How do I focus on a moving subject?	Focus mode	23
How do I choose where the camera focuses?	Focus area	25
Can I change the composition after focusing?	Focus lock	26
How do I improve image quality?	Image quality and size	29–30
How do I take bigger photographs?		
How can I get more photos on the memory card?		
Can I take photos at a reduced size for e-mail?		

Viewing, Printing, and Retouching Photographs

Question	Key phrase	Page #
Can I view my photographs on the camera?	Camera playback	50
Can I view more information about photos?	Photo info	51
Why parts of my photos blink?	Photo info, highlights	52
How do I get rid of an unwanted photo?	Deleting individual photos	54
Can I delete several photos at once?	Delete	65
Can I zoom in on pictures to make sure they're in focus?	Playback zoom	53
Can I protect photos from accidental deletion?	Protect	54
Is there an automatic playback ("slide show") option?	Slide show	67
Can I view my photos on TV?	Television playback	62
How do I copy photos to my computer?	Connecting to a computer	55
How do I print photographs?	Printing photographs	57
Can I print photos without a computer?	Printing via USB	57
Can I print the date on my photographs?	Time stamp, DPOF	59, 61
How do I order professional prints?	Print set	61
How do I bring out details in shadows?	D-lighting	90
Can I get rid of red eye?	Red-eye correction	91
Can I crop photographs on the camera?	Trim	91
Can I create a monochrome copy of a photograph?	Monochrome	92
Can I create a copy with different colors?	Filter effects	92
Can I make a small copy of a photograph?	Small picture	92
Can I overlay two photos to make a single image?	Image overlay	94

Life-Long Learning

As part of Nikon's "Life-Long Learning" commitment to ongoing product support and education, continually-updated information is available on-line at the following sites:

- For users in the U.S.A.: <http://www.nikonusa.com/>
- For users in Europe and Africa: <http://www.europe-nikon.com/support>
- For users in Asia, Oceania, and the Middle East: <http://www.nikon-asia.com/>

Visit these sites to keep up-to-date with the latest product information, tips, answers to frequently-asked questions (FAQs), and general advice on digital imaging and photography. Additional information may be available from the Nikon representative in your area. See the following URL for contact information: <http://nikonimaging.com/>

Introduction



Thank you for your purchase of a Nikon D40 single-lens reflex (SLR) digital camera with interchangeable lenses. This manual has been written to help you enjoy taking pictures with your Nikon digital camera. Read this manual thoroughly before use, and keep it handy when using the product.

To make it easier to find the information you need, the following symbols and conventions are used:

This icon marks cautions, information that should be read before use to prevent damage to the camera.	This icon marks tips, additional information that may be helpful when using the camera.
This icon marks notes, information that should be read before using the camera.	This icon indicates that more information is available elsewhere in this manual or in the <i>Quick Start Guide</i> .
This icon marks settings that can be adjusted using camera menus.	This icon marks settings that can be fine-tuned from the Custom Settings menu.

Lens

Autofocus is supported with AF-S and AF-I lenses only. An 18–55 mm f/3.5–5.6GII ED AF-S DX Zoom Nikkor lens (122) is used in this manual for illustrative purposes.

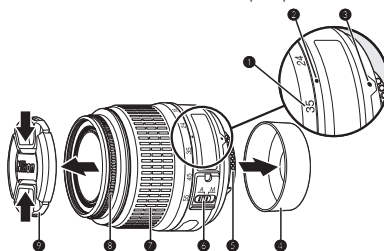







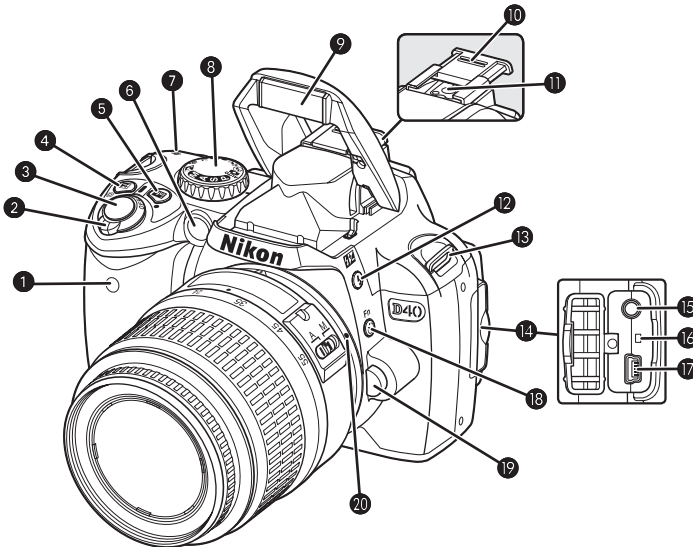

1. Focal length scale
2. Focal length scale index
3. Mounting index: 8
4. Rear cover: 8
5. CPU contacts: 45
6. A-M mode switch: 8, 28
7. Zoom ring
8. Focus ring: 28
9. Lens cap

Getting to Know the Camera

Take a few moments to familiarize yourself with camera controls and displays. You may find it helpful to bookmark this section and refer to it as you read through the rest of the manual.

Camera Body



1 Infrared receiver.....	33	10 Accessory shoe cover.....	99
2 Power switch.....	4	11 Accessory shoe (for optional flash unit).....	99
3 Shutter-release button.....	17	12  (flash mode) button.....	34
4  (exposure compensation) button.....	47	13  (flash compensation) button.....	48
 (aperture) button.....	43	13 Eyelet for camera strap.....	7
Flash compensation.....	48	14 Connector cover.....	55, 58, 62
5  (shooting information) button.....	22	15 Video connector.....	62
● (reset) button.....	38	16 Reset switch.....	108
6 AF-assist illuminator.....	23	17 USB connector.....	55, 58
Self-timer lamp.....	33	18  (self-timer) button.....	33
Red-eye reduction lamp.....	35	Fn (function) button.....	77
7  (focal plane mark).....	28	19 Lens release button.....	8
8 Mode dial.....	4	20 Lens mounting index.....	8
9 Built-in flash.....	34		

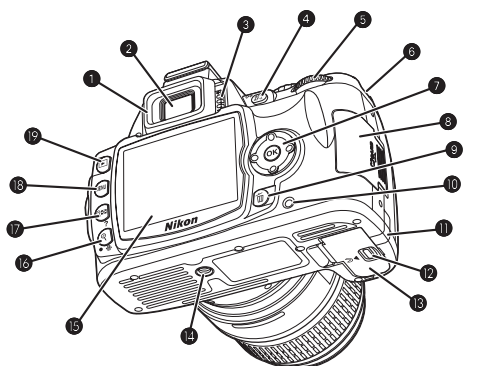

- 1 DK-16 viewfinder eyepiece cup.....7
- 2 Viewfinder eyepiece5, 14
- 3 Diopter adjustment control 14
- 4 (AE-L/AF-L) button.....46, 77
- 5 (protect) button.....54
- 5 Command dial..... 115

- 6 Eyelet for camera strap..... 7
- 7 Multi selector *
- 8 Memory card slot cover 12
- 9 (delete) button20, 54
- 10 Memory card access lamp 12
- 11 Power connector cover for optional AC adapter connector103
- 12 Battery-chamber cover latch 10
- 13 Battery-chamber cover 10, 103
- 14 Tripod socket
- 15 Monitor6, 50, 82
- 16 (playback zoom) button..... 53
- (setting) button 22
- (reset) button 38
- 17 (thumbnail) button..... 52
- (help) button
- 18 (menu) button 63
- 19 (playback) button20, 50



*** Multi selector**

The multi selector is used for menu navigation and playback.

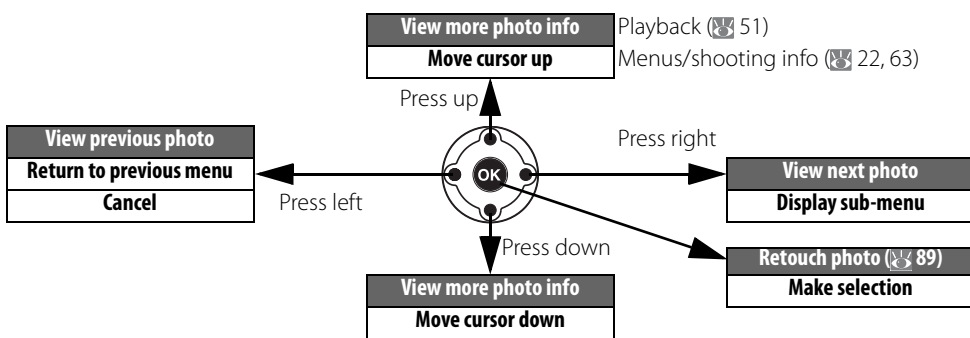

Help

For help on the current mode or menu item, press the button. Help is displayed in the monitor while the button is pressed; to scroll the display, press the multi selector up or down. A blinking icon indicates that help on an error or other problem can be viewed in the monitor by pressing the button.

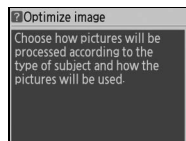

The Mode Dial



The D40 offers a choice of the following twelve shooting modes:

Advanced Modes (Exposure Modes)

Select these modes for full control over camera settings.

P — Programmed auto: 40

A — Aperture-priority auto: 42

S — Shutter-priority auto: 41

M — Manual: 43

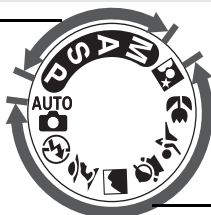

Point-and-Shoot Modes (Digital Vari-Programs)

Selecting a Digital Vari-Program automatically optimizes settings to suit the selected scene, making creative photography as simple as rotating the mode dial.

AUTO — Auto: 15

— Child: 19

— Auto (flash off): 18

— Sports: 19

— Portrait: 18

— Close up: 19

— Landscape: 18

— Night portrait: 19

The Power Switch

The power switch is used to turn the camera on and off.

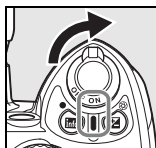

On

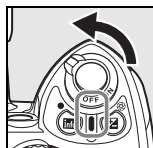

Off

The Viewfinder Display

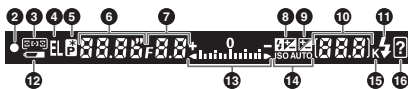
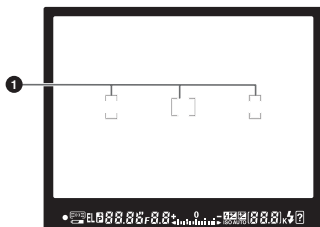

<p>1 Focus brackets (focus areas) 14, 16, 24, 25, 26</p> <p>2 Focus indicator 16, 26</p> <p>3 Focus area display 14, 16, 24, 25, 26</p> <p> AF-area mode 24</p> <p>4 Autoexposure (AE) lock 46</p> <p>5 Flexible program indicator 40</p> <p>6 Shutter speed 39–44</p> <p>7 Aperture (f/-number) 39–44</p> <p>8 Flash compensation indicator 48</p> <p>9 Exposure compensation indicator 47</p>	<p>10 Number of exposures remaining 15, 116</p> <p> Number of shots remaining before memory buffer fills 32, 116</p> <p> Preset white balance recording indicator 71</p> <p> Exposure compensation value 47</p> <p> Flash compensation value 48</p> <p> PC connection indicator 56</p> <p>11 Flash-ready indicator 17</p> <p>12 Battery indicator 15</p> <p>13 Electronic analog exposure display 43</p> <p> Exposure compensation 47</p> <p>14 ISO AUTO indicator 76</p> <p>15 "K" (appears when memory remains for over 1000 exposures)</p> <p>16 Warning indicator 3, 111</p>
--	---

The Viewfinder

The response time and brightness of the viewfinder may vary with temperature. This is normal and does not indicate a malfunction.

Large-Capacity Memory Cards

When enough memory remains on the memory card to record a thousand or more pictures at current settings, the number of exposures remaining will be shown in thousands, rounded down to the nearest hundred (e.g., if there is room for approximately 1,160 exposures, the exposure count display will show 1.1K).



The Shooting Information Display

To view camera settings, press the  button. The following shooting information will be displayed in the monitor. See page 22 for information on changing camera settings.

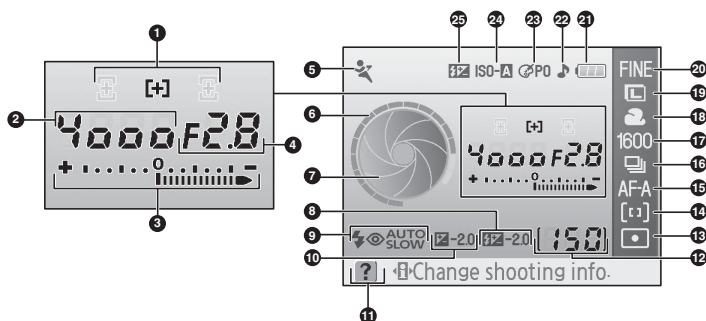

1	Focus area display.....	14, 16, 24, 25, 26	13	Metering mode.....	45
	AF-area mode.....	24	14	AF-area mode.....	24
2	Shutter speed.....	39–44	15	Focus mode.....	23
3	Electronic analog exposure display.....	43	16	Shooting mode.....	32
	Exposure compensation.....	47	17	ISO sensitivity.....	37
4	Aperture (f/-number).....	39–44	18	White balance mode.....	49
5	Mode.....	4	19	Image size.....	30
6	Shutter-speed display		20	Image quality.....	30
7	Aperture display		21	Battery indicator.....	15
8	Flash compensation value.....	48	22	"Beep" indicator.....	74
9	Flash sync mode.....	35	23	Optimize image indicator.....	68
10	Exposure compensation value.....	47	24	Auto ISO sensitivity indicator.....	76
11	Help indicator.....	3	25	Manual flash control indicator.....	78
12	Number of exposures remaining.....	15, 116		Flash compensation indicator for optional Speedlight.....	99
	Preset white balance recording indicator.....	71			
	PC mode indicator.....	56			

Note: Above display is shown when **Graphic** is selected for **Info display format**. See page 81 for other display formats.

The Shutter-Speed and Aperture Displays

These displays provide a visual indication of shutter speed and aperture.



Fast shutter speed, large aperture
(small f/-number)



Slow shutter speed, small aperture
(large f/-number)

Supplied Accessories

The DK-5 Viewfinder Eyepiece Cap

Attach the DK-5 viewfinder eyepiece cap for self-timer (📷 33) or remote control photography (📷 33). Before attaching the DK-5 or other viewfinder accessories (📷 102), remove the DK-16 viewfinder eyepiece cup. Hold the camera firmly when removing the cup.

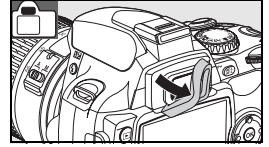

The Camera Strap

Attach the camera strap as shown below.

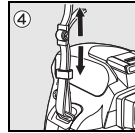
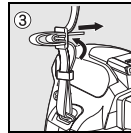
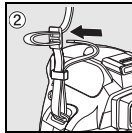
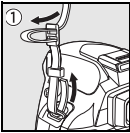

The MH-23 Quick Charger (📷 122)

The MH-23 is for use with the supplied EN-EL9 battery.

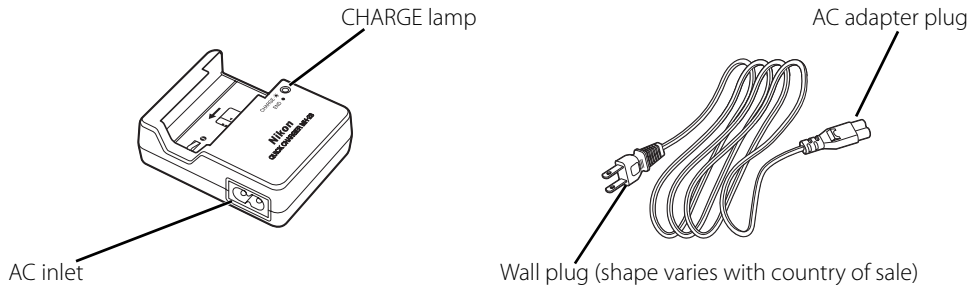

The EN-EL9 Rechargeable Li-ion Battery (📷 103, 121)

The EN-EL9 is for use with the D40.

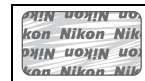
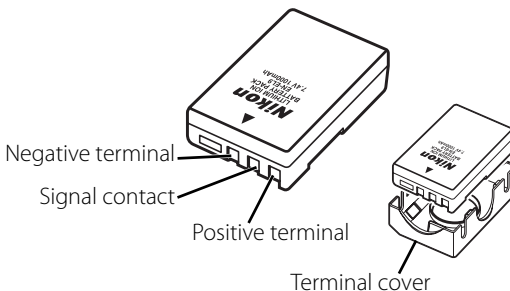

The use of third-party rechargeable Li-ion batteries not bearing the Nikon holographic seal shown above could interfere with normal operation of the camera or result in the batteries overheating, igniting, rupturing, or leaking.

First Steps

Attaching a Lens

Autofocus is supported with AF-S and AF-I lenses only. Care should be taken to prevent dust from entering the camera when exchanging lenses.

- 1 Turn the camera off and remove the body cap.

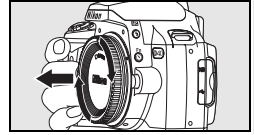

Remove the rear lens cap from the lens.

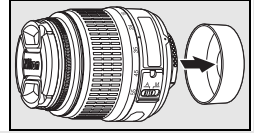

- 2 Keeping the mounting index on the lens aligned with the mounting index on the camera body, position the lens in the camera's bayonet mount and rotate the lens in the direction shown until it clicks into place.

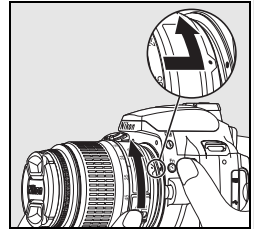

If the lens is equipped with an A-M or M/A-M switch, select A (autofocus) or M/A (autofocus with manual priority).

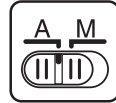

Detaching Lenses

Be sure the camera is off when removing or exchanging lenses. To remove the lens, press and hold the lens-release button while turning the lens clockwise. After removing the lens, replace the camera body cap and rear lens cover.

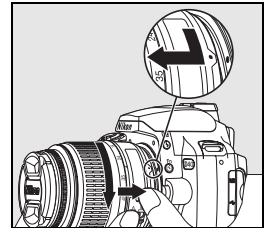

Aperture Ring

If the lens is equipped with an aperture ring, lock aperture at the minimum setting (highest f/-number). See the lens manual for details.

Charging and Inserting the Battery

The supplied EN-EL9 battery is not charged at shipment. Charge the battery using the supplied MH-23 battery charger as described below.

1 Charge the battery.

1.1 Remove the terminal cover from the battery.

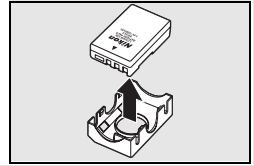

1.2 Connect the power cord to the charger and plug it in.

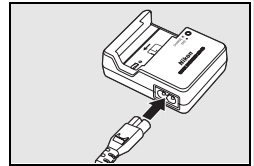

1.3 Place the battery in the charger. The **CHARGE** lamp will blink as the battery charges. About 90 minutes are required for an exhausted battery to fully charge.

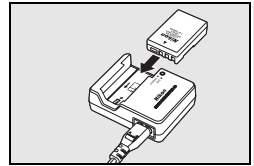

1.4 Charging is complete when the **CHARGE** lamp stops blinking. Remove the battery from the charger and unplug the charger.

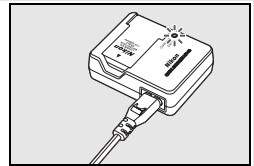

The Battery and Charger

Read and follow the warnings and cautions on pages ii–iii and 106–107 of this manual, together with any warnings and instructions provided by the battery manufacturer.

Do not use the battery at ambient temperatures below 0°C (32°F) or above 40°C (104°F). During charging, the temperature should be in the vicinity of 5–35°C (41–95°F). For best results, charge the battery at temperatures above 20°C (68°F). Battery capacity may drop if the battery is charged or used at lower temperatures.

2 Insert the battery.

2.1 After confirming that the power switch is in the off position, open the battery chamber cover.

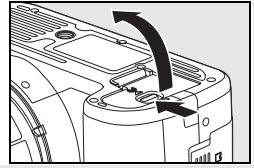

2.2 Insert a fully charged battery as shown at right. Close the battery chamber cover.

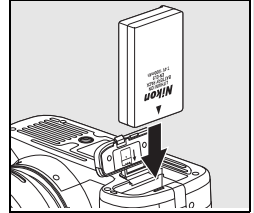











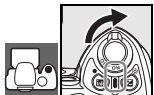



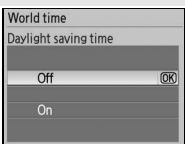

Removing the Battery

Turn the camera off before removing the battery. To avoid shorting the battery, replace the terminal cover when the battery is not in use.

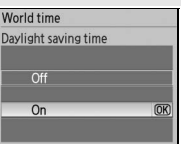
Basic Setup

The first time the camera is turned on, the language selection dialog shown in Step 1 will be displayed in the monitor. Follow the steps below to choose a language and set the time and date. No photographs can be taken until the camera clock has been set.

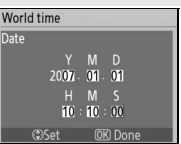

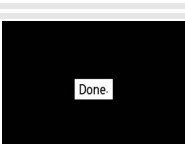
<p>1</p> 	
<p>Turn camera on.</p>	
<p>2</p> 	
<p>Select language.</p>	
<p>3</p> 	
<p>Display map of world time zones.*</p>	
<p>4</p> 	
<p>Select local time zone.</p>	
<p>* UTC field shows time difference between selected time zone and Coordinated Universal Time (UTC), in hours.</p>	
<p>5</p> 	
<p>Display daylight saving time options.</p>	
<p>6</p> 	
<p>Highlight On if daylight saving time is in effect.</p>	
<p>7</p> 	
<p>Display date menu.</p>	
<p>8</p> 	
<p>Press multi selector left or right to select item, up or down to change.</p>	
<p>9</p> 	
<p>Exit to shooting mode.</p>	
<p>To reset the camera clock, choose a new time zone, turn daylight saving time on or off, or choose the order in which the year, month, and date are displayed, use the World time option in the setup menu (83).</p>	

Using Camera Menus

The language menu is only displayed automatically the first time the camera is turned on. See the Menu Guide (63) for information on normal menu operation.

Inserting Memory Cards

The camera stores pictures on Secure Digital (SD) memory cards (available separately).

1 Insert a memory card.

- 1.1** Before inserting or removing memory cards, *turn the camera off* and open the card slot cover.

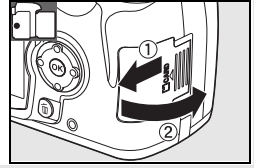

- 1.2** Slide the memory card in as shown at right until it clicks into place. The memory card access lamp will light for about a second. Close the memory card slot cover.

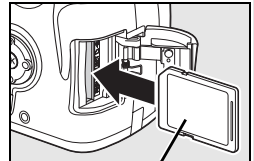

Front

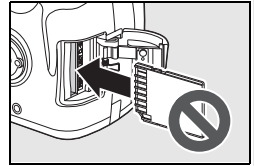

Removing Memory Cards

1. Confirm that the access lamp is off.
2. Turn the camera off and open the memory card slot cover.
3. Press the card in to eject (①). The card can then be removed by hand (②).

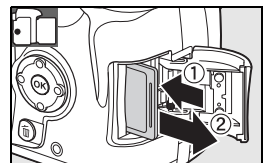

2 Memory cards must be formatted in the camera before first use. Note that formatting memory cards permanently deletes all photographs and other data they may contain. Be sure all data you wish to keep have been copied to another storage device before formatting the card.



2.1

Turn camera on.

2.2

Display menus.*

* If menu item is highlighted, press multi selector left to highlight icon for current menu.

2.3

Highlight .

2.4

Position cursor in setup menu.

2.5

Highlight **Format memory card**.

2.6

Display options.

2.7

Highlight **Yes**.

2.8

Format card. Do not turn camera off or remove card or battery until formatting is complete and setup menu is displayed.

Formatting Memory Cards

Use the camera **Format memory card** option to format memory cards. Performance may drop if cards are formatted in a computer.

The Write Protect Switch

SD cards are equipped with a write protect switch to prevent accidental loss of data. When this switch is in the "lock" position, the camera will display a message to warn that photos can not be recorded or deleted and the memory card can not be formatted.



Write-protect switch

Adjusting Viewfinder Focus

Photographs are framed in the viewfinder. Before shooting, make sure that the display in the viewfinder is in clear focus.

- 1 Remove the lens cap and turn the camera on.

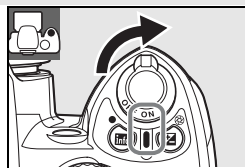

- 2 Slide the diopter adjustment control up and down until the focus brackets are in sharp focus. When operating the diopter adjustment control with your eye to the viewfinder, be careful not to put your fingers or fingernails in your eye.

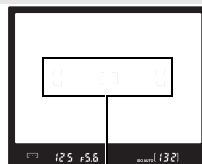

Focus brackets

Auto Meter Off

At default settings, the viewfinder and shooting information display will turn off if no operations are performed for about eight seconds (auto meter off), reducing the drain on the battery. Press the shutter-release button halfway to reactivate the display in the viewfinder.

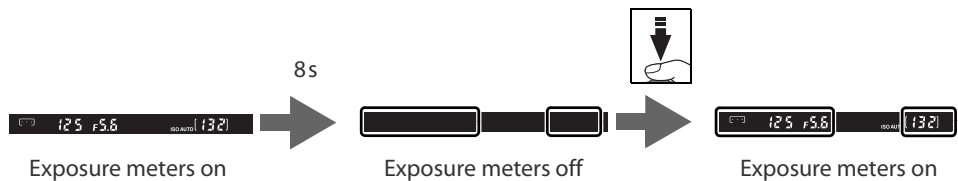

The length of time before the exposure meters turn off automatically can be adjusted using Custom Setting 15 (**Auto off timers**;  78).

“Point-and-Shoot” Photography (AUTO Mode)

This section describes how to take photographs in **AUTO** (auto) mode, an automatic “point-and-shoot” mode in which the majority of settings are controlled by the camera in response to shooting conditions.

1 Turn the camera on.

1.1 Remove the lens cap and turn the camera on. The monitor will turn on and the viewfinder display will light.

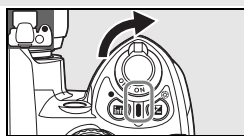

1.2 If the monitor is off, press the **INFO** button to display shooting information. Check the battery level as described below.

Monitor	Viewfinder	Description
	—	Battery fully charged.
	—	Battery partially discharged.
		Low battery. Prepare to charge battery.
		Shutter release disabled. Charge battery. (blinks) (blinks)

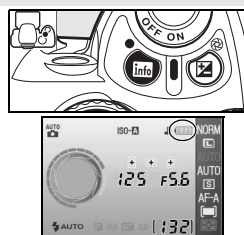

If shooting information is not displayed when the **INFO** button is pressed, the battery is exhausted. Charge the battery.

1.3 The number of photographs that can be stored on the memory card is shown in the shooting information display and viewfinder. Check the number of exposures remaining.

If there is not enough memory to store additional photographs at current settings, the display will flash as shown at right. No further pictures can be taken until the memory card has been replaced or photographs have been deleted (20, 65).

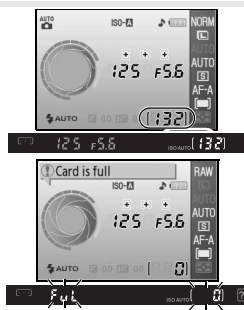

2 Rotate the mode dial to **AUTO** (auto mode).

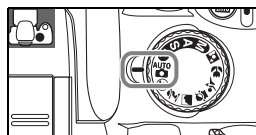

3 Frame a photograph in the viewfinder.

3.1 Hold the camera as shown.

Holding the Camera

Hold the handgrip in your right hand and cradle the camera body or lens with your left. Keep your elbows propped lightly against your torso for support and place one foot half a pace ahead of the other to keep your upper body stable.



3.2 Frame a photo in the viewfinder with the main subject positioned in any of the three focus areas.

Using a Zoom Lens

Use the zoom ring to zoom in on the subject so that it fills a larger area of the frame, or zoom out to increase the area visible in the final photograph (select longer focal lengths to zoom in, shorter focal lengths to zoom out).

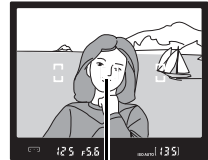

Focus area

Zoom in

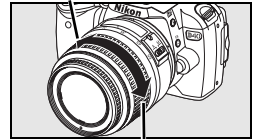

Zoom out

4 Focus and shoot.

4.1 Press the shutter-release button halfway. The camera will automatically select the focus area containing the subject closest to the camera and focus on this subject. If the subject is dark, the AF-assist illuminator may light to assist the focus operation and the flash may pop up. The monitor will turn off.

When the focus operation is complete, the selected focus area will be highlighted, a beep will sound, and the in-focus indicator (●) will appear in the viewfinder. The number of exposures that can be stored in the memory buffer ("r";  32) is shown in the viewfinder display while the shutter-release button is pressed halfway.

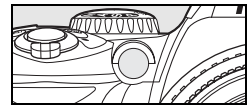
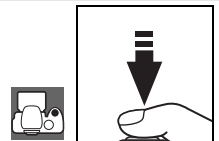

4.2 Smoothly press the shutter-release button the rest of the way down to release the shutter and record the photograph. The access lamp next to the memory card slot cover will light. *Do not eject the memory card or remove or disconnect the power source until the lamp has gone out and recording is complete.*

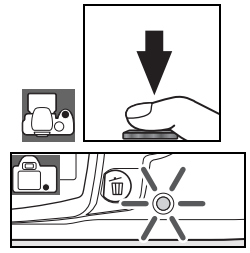



5 Turn the camera off when shooting is complete.

The Shutter-Release Button

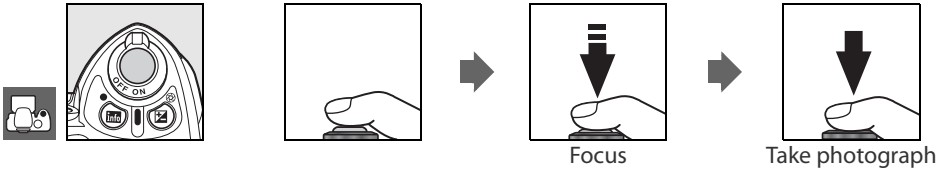
The camera has a two-stage shutter-release button. The camera focuses and the monitor turns off when the shutter-release button is pressed halfway. To take the photograph, press the shutter-release button the rest of the way down.



The Built-in Flash

If additional lighting is required for correct exposure in **AUTO** mode, the built-in flash will pop up automatically when the shutter-release button is pressed halfway (to prevent the flash from firing when lighting is poor, select  Auto (flash off) mode). Flash range varies with aperture and ISO sensitivity ( 117); remove lens hoods when using the flash. If the flash is raised, photographs can only be taken when the flash-ready indicator () is displayed. If the flash-ready indicator is not displayed, remove your finger briefly from the shutter-release button and try again.

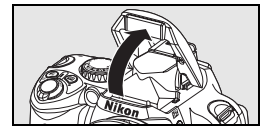



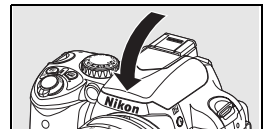



To save battery power when the flash is not in use, return it to its closed position by pressing it gently downward till the latch clicks into place. For more information on using the flash, see page 34.



Creative Photography (Digital Vari-Programs)

In addition to , the D40 offers a choice of seven Digital Vari-Program modes. Selecting a program automatically optimizes settings to suit the selected scene, making creative photography as easy as rotating the mode dial.

Mode	Description
 Auto (flash off)	For pictures that do not use the flash.
 Portrait	For portraits.
 Landscape	For natural and man-made landscapes.
 Child	For pictures of children.
 Sports	For moving subjects
 Close up	For close up shots of flowers, insects, and other small objects.
 Night portrait	For portraits taken under low light.

To take photographs in Digital Vari-Program modes:

- 1 Rotate the mode dial to select a Digital Vari-Program mode.

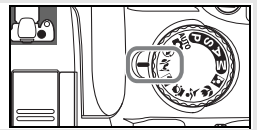

- 2 Frame a photograph in the viewfinder, focus, and shoot.

Digital Vari-Program modes are described below.

Auto (Flash Off)

The built-in flash turns off. Use where flash photography is prohibited, to photograph infants without using the flash, or to capture natural lighting under low light. The camera selects the focus area containing the closest subject; the AF-assist illuminator will light to assist the focus operation when lighting is poor.



Portrait

Use for portraits with soft, natural-looking skin tones. The camera selects the focus area containing the closest subject. If the subject is far from the background or a telephoto lens is used, background details will be softened to lend the composition a sense of depth.



Landscape

Use for vivid landscape shots. The camera selects the focus area containing the closest subject; the built-in flash and AF-assist illuminator turn off automatically.



Child

Use for snapshots of children. Clothing and background details are vividly rendered while skin tones are given a soft, natural finish. The camera selects the focus area containing the closest subject.



Sports

High shutter speeds freeze motion for dynamic sports shots in which the main subject stands out clearly. The camera focuses continuously while the shutter-release button is pressed halfway, tracking the subject in the center focus area. If the subject leaves the center focus area, the camera will continue to focus based on information from the other focus areas. The starting focus area can be selected with the multi selector. The built-in flash and AF-assist illuminator turn off automatically.



Close Up

Use for close-up shots of flowers, insects, and other small objects. The camera automatically focuses on the subject in the center focus area; other focus areas can be selected using the multi selector. Use of a tripod is recommended to prevent blur.





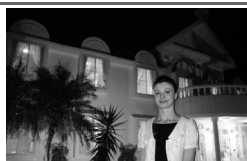

Night Portrait

Use for a natural balance between the main subject and the background in portraits taken under low light. The camera selects the focus area containing the closest subject. Use of a tripod is recommended to prevent blur.





The Built-in Flash

If additional lighting is required for correct exposure in , , , or  mode, the built-in flash will pop automatically when the shutter-release button is pressed halfway. See “Using the Built-in Flash” for information on choosing a flash mode ( 34).

Basic Playback

Photographs are automatically displayed after shooting. The battery level and number of exposures remaining are also displayed.



If no photograph is displayed in the monitor, the most recent picture can be viewed by pressing the  button ( 50).

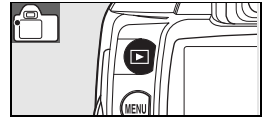



Additional pictures can be displayed by rotating the command dial or pressing the multi selector left or right.

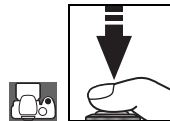

To end playback and return to shooting mode, press the shutter-release button halfway.



Deleting Unwanted Photographs

To delete the photograph currently displayed in the monitor, press the  button. A confirmation dialog will be displayed. Press the  button again to delete the image and return to playback. To exit without deleting the picture, press the  button.

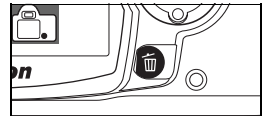

Reference

This section builds on the Tutorial to cover more advanced shooting and playback options.

More on Photography (All Modes): 📷 22

Use the shooting information display	The Shooting Information Display: 📷 22
Shoot a moving subject or focus manually	Focus: 📷 23
Adjust image quality and size	Image Quality and Size: 📷 29
Take photographs in one at a time, in bursts, or using the self-timer or a remote control	Shooting Mode: 📷 32
Use the built-in flash	Using the Built-in Flash: 📷 34
Raise ISO sensitivity when lighting is poor	ISO Sensitivity: 📷 37
Restore default settings	Two-Button Reset: 📷 38

P, S, A, and M Modes: 📷 39

Let the camera choose shutter speed and aperture	Mode P (Programmed Auto): 📷 40
Freeze or blur motion	Mode S (Shutter-Priority Auto): 📷 41
Choose whether to blur background objects	Mode A (Aperture-Priority Auto): 📷 42
Choose shutter speed and aperture manually	Mode M (Manual): 📷 43
Choose how the camera meters exposure, lock exposure, adjust exposure and flash level	Exposure: 📷 45
Make colors look natural Take photos under unusual lighting	White Balance: 📷 49

See the Menu Guide for information on other operations that can only be performed in P, S, A, and M modes, including customizing sharpening, contrast, color saturation, and hue (“Optimize Image”; 📷 68, 69).

More on Playback: 📷 50

View photographs on the camera	Viewing Photographs on the Camera: 📷 50
--------------------------------	--

See the Menu Guide for other playback options (📷 65–67).





Connecting to a Computer, Printer, or TV: 📷 55

Copy photographs to a computer	Connecting to a Computer: 📷 55
Print photographs	Printing Photographs: 📷 57
View photographs on TV	Viewing Photographs on TV: 📷 62



More on Photography (All Modes)





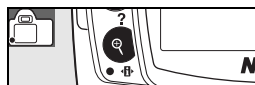

The Shooting Information Display

Pressing the  button displays shooting information in the monitor. Shooting information is also displayed when the , , or  (P, S, and A modes only) buttons are pressed, and immediately after the camera is turned on. The display format depends on the option selected for **Info display format** in the setup menu ( 81).

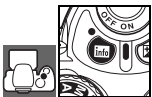
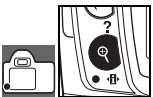

The  button can be used to change the settings shown in the shooting information display.



- 
Display shooting information.
- 
Selected setting is highlighted.
- 
Highlight desired setting. Settings not available in current mode are grayed out and can not be selected.
- 
Display options for highlighted setting.
- 
Highlight desired option.*
- 
Select option. Repeat Steps 3–6 to change other settings, or press  to return to Step 1.
- 
Take pictures. Monitor turns off while shutter-release button is pressed.

* Press  to return to Step 3 without modifying setting.

Focus

Focus can be adjusted automatically (see “Focus Mode,” below) or manually (📷 28). The user can also select the focus area for automatic or manual focus (📷 24, 25) or use focus lock to focus to recompose photographs after focusing (📷 26).

Focus Mode

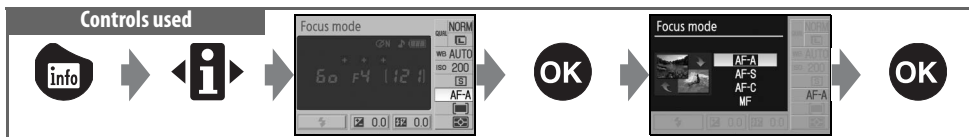

Choose how the camera focuses. **AF-S** and **AF-C** are available only in P, S, A, and M modes.

Focus mode	Description
AF-A Auto-servo AF (default setting)	Camera automatically selects single-servo autofocus when subject is judged to be stationary, continuous-servo autofocus when subject is judged to be moving. Shutter can be released if camera is able to focus.
AF-S Single-servo AF	For stationary subjects. Focus locks when shutter-release button is pressed halfway. Shutter can be released if camera is able to focus.
AF-C Continuous-servo AF	For moving subjects. Camera focuses continuously while shutter-release button is pressed halfway. Shutter can be released if camera is able to focus.
MF Manual focus	User focuses manually (📷 28).

The AF-Assist Illuminator

If the subject is poorly lit, the AF-assist illuminator will light automatically to assist the autofocus operation when the shutter-release button is pressed halfway. The AF-assist illuminator will not light in continuous-servo AF or manual focus mode, in 📷 or 📷 modes, or if **Off** has been selected for Custom Setting 9 (**AF assist**). The illuminator has a range of about 0.5–3.0m (1ft. 8in.–9ft. 10in.); when using the illuminator, use a lens with a focal length of 24–200mm and remove the lens hood.

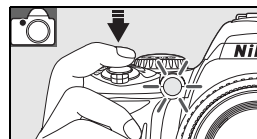

2 — Focus Mode (📷 75)

Focus mode can also be selected from the Custom Settings menu.

AF-Area Mode

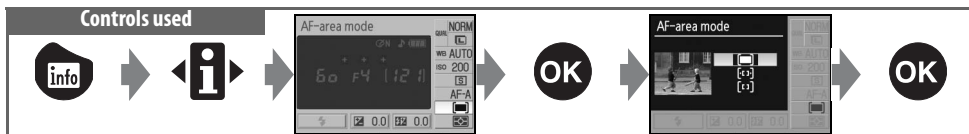

Choose how the focus area is selected in autofocus mode. This setting has no effect in manual focus mode.

Option	Description
Closest subject	Camera automatically selects focus area containing subject closest to camera. Default for P, S, A, and M modes; selected automatically when mode dial is rotated to , , , or .
Dynamic area	User selects focus area manually, but if subject leaves selected focus area even briefly, camera will focus based on information from other focus areas. Use with erratically moving subjects. Selected automatically when mode dial is rotated to .
Single area	User selects focus area using multi-selector; camera focuses on subject in selected focus area only. Use with stationary subjects. Selected automatically when mode dial is rotated to .

Viewfinder Display

AF-area mode is shown in the viewfinder as follows:

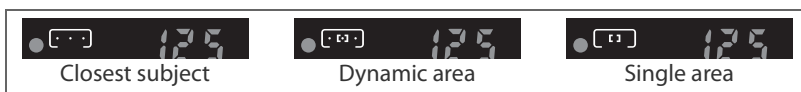

3 — AF-Area Mode (p. 75)







AF-area mode can also be selected from the Custom Settings menu.

Focus Area Selection

Controls used

Multi selector

The D40 offers a choice of three focus areas. At default settings, the camera chooses the focus area automatically or focuses on subject in the center focus area, but the focus area can also be selected manually to compose photographs with the main subject positioned at either side of the frame.

- 1 At default settings, the focus area is selected automatically in **AUTO**, , , , , , , **P**, **S**, **A**, and **M** modes. To enable manual focus selection in these modes, select **Single area** or **Dynamic area** for AF-area mode in the shooting information display ( 24).



- 2 Press the multi selector left or right to select the focus area in the viewfinder or shooting information display.



Focus Lock

Controls used Shutter-release button/AE-L/AF-L button

Focus lock can be used to change the composition after focusing, making it possible to focus on a subject that will not be in a focus area in the final composition. It can also be used when the autofocus system is unable to focus (📷 27). Single or dynamic area AF is recommended when using focus lock (📷 24).

- 1 Position the subject in the selected focus area and press the shutter-release button halfway to initiate focus.

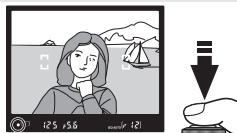

- 2 Check that the in-focus indicator (●) appears in the viewfinder. Focus will lock automatically when the in-focus indicator appears, and remain locked while the shutter-release button is pressed halfway. Focus can also be locked by pressing the AE-L/AF-L button while the shutter-release button is pressed halfway. Focus will remain locked while the AE-L/AF-L button is pressed, even if you later remove your finger from the shutter-release button.

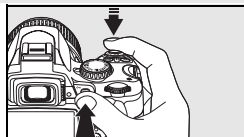

- 3 Recompose the photograph and shoot.

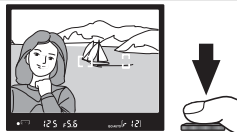



The shutter-release button can not be used to lock focus in 📷 mode (📷 19), continuous shooting mode (📷 32), or continuous servo autofocus (📷 23). Use the AE-L/AF-L button to lock focus. At other settings, focus will remain locked between shots if the shutter-release button is kept pressed halfway.

📷 12 — AE-L/AF-L (📷 77)

This option controls the behavior of the AE-L/AF-L button.

Getting Good Results with Autofocus

Autofocus does not perform well under the conditions listed below. If the camera is unable to focus using autofocus, use manual focus ( 28) or use focus lock ( 26) to focus on another subject at the same distance and then recompose the photograph.

There is little or no contrast between the subject and the background (e.g., the subject is the same color as the background).



The focus area contains objects at different distances from the camera (e.g., the subject is inside a cage).



The subject is dominated by regular geometric patterns (e.g., a row of windows in a skyscraper).

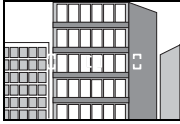

The focus area contains areas of sharply contrasting brightness (e.g., the subject is half in the shade).

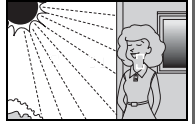

The subject appears smaller than the focus area (e.g., focus area contains both foreground subject and distant buildings).



The subject contains many fine details (e.g., a field of flowers or other subjects that are small or lack variation in brightness).



Manual Focus

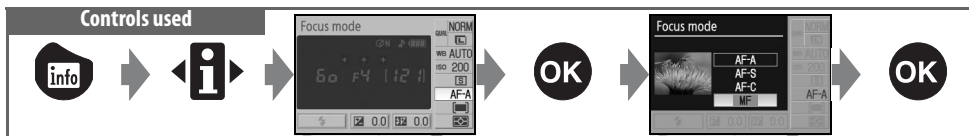

Use this option when you wish to adjust focus manually or when using a manual focus lens. To focus manually, select manual focus mode and adjust the lens focusing ring until the image displayed on the clear matte field in the viewfinder is in focus. Photographs can be taken at any time, even when the image is not in focus.

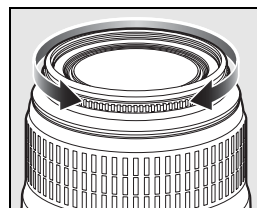

When using a lens that offers A-M selection, select M when focusing manually. With lenses that support M/A (autofocus with manual priority), focus can be adjusted manually with the lens set to M or M/A. See the documentation provided with your lens for details.

The Electronic Range Finder

If the lens has a maximum aperture of $f/5.6$ or faster, the viewfinder focus indicator can be used to confirm whether the portion of the subject in the selected focus area is in focus. After positioning the subject in the active focus area, press the shutter-release button halfway and rotate the lens focusing ring until the in-focus indicator (●) is displayed.



Focal Plane Position

To determine the distance between your subject and the camera, measure from the focal plane mark on the camera body. The distance between the lens mounting flange and the focal plane is 46.5mm (1.83in.).



Image Quality and Size

Together, image quality and size determine how much space each photograph occupies on the memory card. Larger, higher quality images can be printed at larger sizes but also require more memory, meaning that fewer such images can be stored on the memory card.

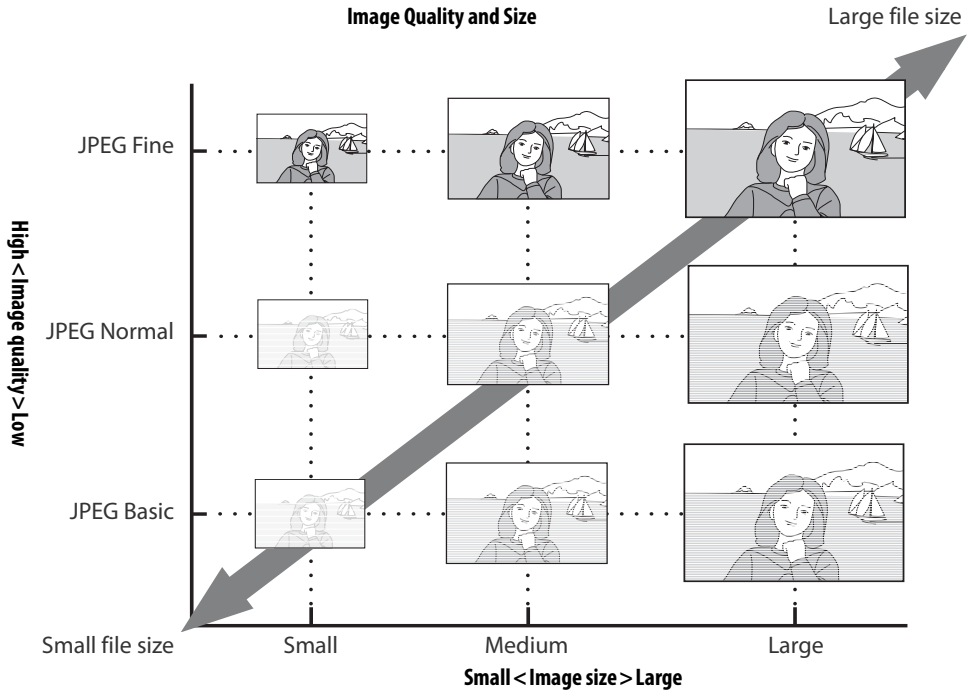

Changes to image quality and size are reflected in the number of exposures remaining as shown in the shooting information display and viewfinder (📷 5, 6). The approximate maximum file size of individual photographs and the total number of pictures that can be recorded at the selected setting are also shown in the shooting information display while image quality or size options are displayed (📷 30). Actual file size and memory card capacity may differ. Typical file sizes are listed on page 116.



Image Quality

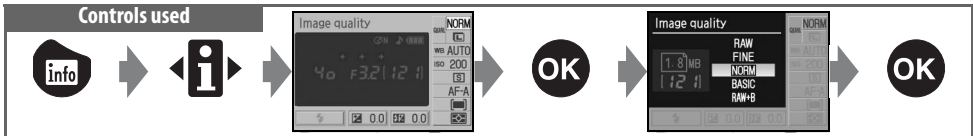

The camera supports the following image quality options (listed in descending order by image quality and file size):

Option	Format	Description
RAW	NEF	Compressed raw data from the image sensor are saved directly to memory card. Choose for images that will be retouched on a computer.
FINE	JPEG	Images are compressed less than NORM , producing higher-quality images. Compression ratio: roughly 1:4.
NORM (default)		Best choice in most situations. Compression ratio: roughly 1:8.
BASIC		Smaller file size suited to e-mail or the Web. Compression ratio: roughly 1:16.
RAW + B	NEF + JPEG	Two images are recorded: one NEF (RAW) image and one basic-quality JPEG image.

Image Size

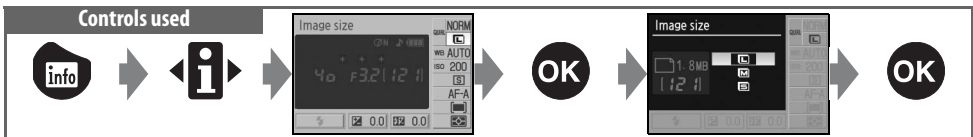



Image size is measured in pixels. The following options are available:

Image size	Size (pixels)	Approximate size when printed at 200 dpi
L (default)	3,008×2,000	38.2×25.4 cm (15.0×10.0 in.)
M	2,256×1,496	28.6×19.0 cm (11.3×7.5 in.)
S	1,504×1,000	19.1×12.7 cm (7.5×5.0 in.)

Note that the option selected for image size does not affect the size of NEF (RAW) images. When viewed on a computer, NEF images are 3,008×2,000 pixels in size.

NEF (RAW)/RAW+B

Capture NX (available separately;  103) or the supplied PictureProject software are required to view NEF (RAW) images on a computer. NEF (RAW) photographs can not be printed by most print services or by direct USB connection; use PictureProject or Capture NX to print NEF (RAW) photographs. When photographs taken at **RAW+B** are viewed on the camera, only the JPEG image will be displayed. When photographs taken at this setting are deleted, both NEF and JPEG images will be deleted.

File Names

Photographs are stored as image files with names of the form “DSC_nnnn.xxx,” where *nnnn* is a four-digit number between 0001 and 9999 assigned automatically in ascending order by the camera, and *xxx* is one of the following three letter extensions: “NEF” for NEF (RAW) images or “JPG” for JPEG images. The NEF and JPEG files recorded at a setting of **RAW+B** have the same file names but different extensions. Small copies created with the small picture option in the retouch menu have file names beginning with “SSC_” and ending with the extension “JPG” (e.g., “SSC_0001.JPG”), while images recorded with the other options in the retouch menu have file names beginning with “CSC” (e.g., “CSC_0001.JPG”). Images recorded at a **Optimize Image > Custom > Color Mode** setting of **II (AdobeRGB)** ( 69) have names that begin with an underscore (e.g., “_DSC0001.JPG”).

Image Quality (30)/Image Size (30)

Image quality and size can also be set using the **Image quality** and **Image size** options in the shooting menu.

11— Fn Button (77)

Image quality and size can also be set using the command dial.

Shooting Mode

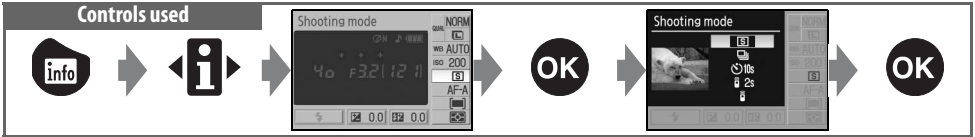

Shooting mode determines how the camera takes photographs: one at a time, in a continuous sequence, with a timed shutter-release delay, or with a remote control.

Mode	Description
Single frame (default)	Camera takes one photograph each time shutter-release button is pressed.
Continuous (burst mode)	Camera records photographs at up to about 2.5 frames per second while shutter-release button is pressed (note that photographs taken at an ISO sensitivity of HI 1 are automatically processed to reduce noise, increasing recording time by about 1 second per frame). Only one shot will be taken if flash fires; select Auto (flash off) mode (18) or turn flash off (35) for burst photography.
Self-timer	Use for self-portraits or to reduce blurring caused by camera shake (33).
Delayed remote	Optional ML-L3 remote control required. Use for self-portraits (33).
Quick-response remote	Optional ML-L3 remote control required. Use to reduce blurring caused by camera shake (33).

11 — /Fn Button (33)

If **Self-timer** (the default option) is selected for Custom Setting 11 (/Fn button), self-timer mode can also be selected by pressing the self-timer button.

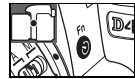

The Memory Buffer

The camera is equipped with a memory buffer for temporary storage, allowing shooting to continue while photographs are being saved to the memory card. When the buffer is full, the shutter is disabled until enough data have been transferred to the memory card to make room for another photograph. In continuous mode, shooting will continue to a maximum of 100 shots, although the frame rate will drop once the buffer has filled. See the Appendix for information on the number of photographs that can be stored in the memory buffer.

The approximate number of images that can be stored in the memory buffer at current settings is shown in the exposure-count display in the viewfinder while the shutter-release button is pressed.





Self-Timer and Remote Control Modes

The self-timer or optional ML-L3 remote control can be used for self-portraits.

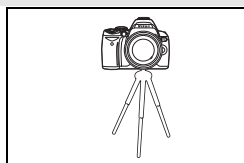
- 1 Mount the camera on a tripod or place the camera on a stable, level surface.



- 2 Select one of the following shooting modes:

Mode	Description
 10s	Self-timer Shutter released about 10s after camera has focused.
 2s	Delayed remote Shutter released about 2s after camera has focused.
	Quick-response remote Shutter released when camera focuses.

- 3 Frame the photograph. If the remote control is used with the camera in autofocus mode, you can check focus by pressing the shutter-release button halfway.

- 4 Remove the viewfinder eyepiece cup and insert the supplied DK-5 eyepiece cap as shown. This prevents light entering via the viewfinder interfering with exposure.

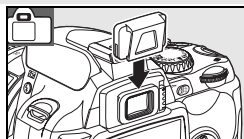

- 5 Take the photograph.

Self-timer: Press the camera shutter-release button halfway to focus, then press it the rest of the way down to start the self-timer. The self-timer lamp will start to blink, stopping two seconds before the photograph is taken.

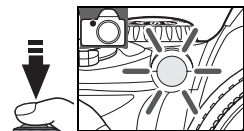

Remote control: From a distance of 5 m (16ft.) or less, aim the transmitter on the ML-L3 at the infrared receiver on the camera and press the shutter-release button on the ML-L3. In delayed remote mode, the self-timer lamp will light for about two seconds before the shutter is released. In quick-response remote mode, the self-timer lamp will flash after the shutter has been released.

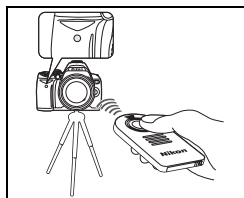

Self-timer mode ends when a photograph is taken or the camera is turned off. Single-frame or continuous shooting mode is automatically restored when self-timer mode ends.

Using the Built-in Flash

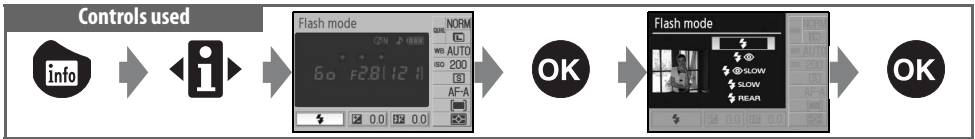

The camera supports a variety of flash modes for photographing poorly lit or backlit subjects. The flash modes available depend on the mode selected with the mode dial; note that the flash can not be used in , , or mode. The default flash setting for Digital Vari-Program modes is automatically restored when the mode dial is rotated to a new setting or the camera is turned off.

Using the Built-in Flash: , , , and Modes

- 1 Rotate the mode dial to , , , or .
- 2 Choose a flash mode.
- 3 Take pictures. Unless (off) is selected, the flash will pop up as required when the shutter-release button is pressed halfway and fire when a photograph is taken.



Using the Built-in Flash: P, S, A, and M Modes

- 1 Rotate the mode dial to P, S, A, or M.
- 2 Press the button to raise the flash.
- 3 Choose a flash mode.
- 4 Choose a metering method and adjust exposure.
- 5 Take pictures. The flash will fire whenever a picture is taken. To prevent the flash from firing, lower the flash.



Lowering the Built-in Flash

To save power when the flash is not in use, press it gently downward until the latch clicks into place.

Flash Mode

The flash modes available depend on the mode currently selected with the mode dial.

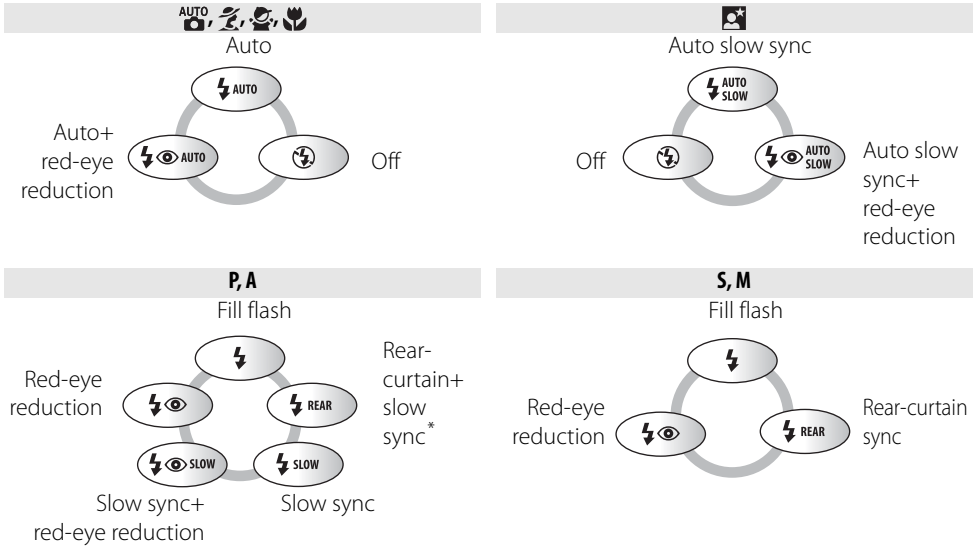



* **SLOW** is displayed after command dial is released.

Flash modes are described below.

- **AUTO** (auto flash): When lighting is poor or subject is back lit, flash pops up automatically when shutter-release button is pressed halfway and fires as required.
- **Red-eye reduction** (eye icon): Use for portraits. AF-assist lamp lights before flash fires, reducing “red-eye.”
- **SLOW** (slow sync): Shutter speed slows automatically to capture background lighting at night or under low light. Use to include background lighting in portraits.
- **REAR** (rear curtain sync): Flash fires just before shutter closes, creating the effect of a stream of light behind moving subjects. If this icon is not displayed, flash will fire immediately after shutter opens.

The Flash Button

Flash mode can also be selected by pressing the  button and rotating the command dial. In P, S, A, and M modes, press the  button once to raise the flash and then select a flash mode by pressing the  button and rotating the command dial.

Custom Settings (76, 78)

Use Custom Setting 10 (**ISO auto**) to adjust sensitivity for optimal flash output. Custom Setting 14 (**Built-in Flash**) can be used for manual flash control.

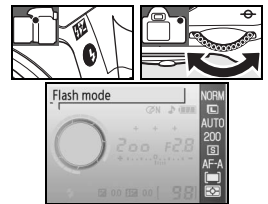

The Built-in Flash

Use with CPU lenses with focal lengths of 18–300mm or non-CPU lenses with focal lengths of 18–200mm (📖 97–98). Remove lens hoods to prevent shadows. Lenses that block the subject's view of the AF-assist lamp may interfere with red-eye reduction. The flash has a minimum range of 60cm (2ft.) and can not be used in the macro range of macro zoom lenses.

If the flash fires in continuous shooting mode (📖 32), only one picture will be taken each time the shutter-release button is pressed.

The shutter release may be briefly disabled to protect the flash after it has been used for several consecutive shots. The flash can be used again after a short pause.

For information on optional flash units (Speedlights), see “Optional Flash Units (Speedlights)” (📖 99). See “Flash Compensation” for information on controlling flash level (📖 48).

Rear-Curtain Sync

Normally the flash fires as the shutter opens (“front curtain sync”; see below at left). In rear-curtain sync, the flash fires just before the shutter closes, creating the effect of a stream of light behind moving subjects.

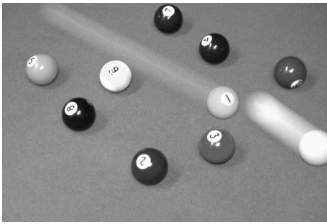

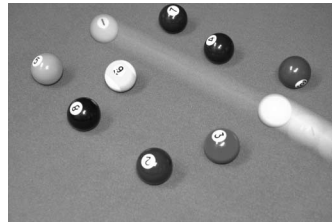

Front-curtain sync

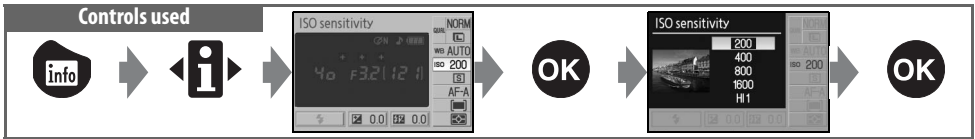

Rear curtain sync

ISO Sensitivity



Photographs taken at slow shutter speeds are prone to blurring. If ISO sensitivity is raised above the base setting of ISO 200 equivalent, the same exposures can be achieved at faster shutter speeds, preventing blur. ISO sensitivity can be set to values between ISO 200 and ISO 1600 in steps of 1 EV, with a further high sensitivity setting of **HI 1** available for an ISO equivalent of roughly 3200.  (auto) and Digital Vari-Program modes also offer an **Auto** setting that allows the camera to automatically raise sensitivity when lighting is poor or lower sensitivity when lighting is bright. Rotating the mode dial from **P**, **S**, **A**, or **M** to  or a Digital Vari-Program mode automatically restores the default ISO sensitivity of **Auto**.

Sensitivity

ISO sensitivity is the digital equivalent of film speed. The higher the ISO sensitivity, the less light needed to make an exposure, allowing higher shutter speeds or smaller apertures. Just as higher speed films tend to be “grainy,” pictures taken at high ISO sensitivities are prone to mottling. Photos taken at an ISO sensitivity of **HI 1** are automatically processed to reduce noise, resulting in increased recording times.

ISO Sensitivity

ISO sensitivity can also be set using the **ISO sensitivity** option in the shooting menu.

10—ISO Auto



This option can be used to enable automatic ISO sensitivity control in **P**, **S**, **A**, and **M** modes. When **HI 1** is selected, automatic ISO sensitivity control is disabled.

11—/Fn Button









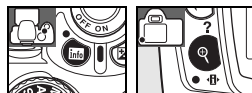





ISO sensitivity can also be set using the command dial.

Two-Button Reset











Controls used:  button +  button

The camera settings listed below can be restored to default values by holding the  and  buttons down together for more than two seconds (these buttons are marked by a green dot). The monitor turns off briefly while settings are reset. Custom Settings are not affected.



Option	Default
Image quality  30	JPEG Normal
Image size  30	Large
White balance  49*	Auto
ISO sensitivity  37	
 Digital Vari-Program	Auto
P, S, A, M	200
Shooting mode  32	Single frame
Focus mode  23	AF-A
AF-area mode  24	
    P, S, A, M	Closest subject
	Dynamic area
	Single area

* Fine-tuning  70 reset to 0.

Option	Default
Metering  45	Matrix
Flash compensation  48	±0
Exposure compensation  47	±0
Flash sync mode  34	
   	Auto
	Auto slow sync
P, S, A, M	Fill flash
Focus area  25	Center
Flexible program  40	Off

Default Settings

See the Appendix for a list of default settings  113).

P, S, A, and M Modes

P, S, A, and M modes offer control over a variety of advanced settings, including exposure (📷 45), white balance, and image optimization. Each of these modes offers a different degree of control over shutter speed and aperture:

Mode	Description
P Programmed auto (📷 40)	Camera sets shutter speed and aperture for optimal exposure. Recommended for snapshots and in other situations in which there is little time to adjust camera settings.
S Shutter-priority auto (📷 41)	User chooses shutter speed; camera selects aperture for best results. Use to freeze or blur motion.
A Aperture-priority auto (📷 42)	User chooses aperture; camera selects shutter speed for best results. Use to blur background or bring both foreground and background into focus.
M Manual (📷 43)	User controls both shutter speed and aperture. Set shutter speed to “bulb” or “—” for long time-exposures.

🔧 Lens Aperture Ring

When using a CPU lens equipped with an aperture ring, lock the aperture ring at the minimum aperture (highest f/-number). Type G lenses are not equipped with an aperture ring.

Non-CPU lenses can only be used in exposure mode M, when aperture can be adjusted manually using the lens aperture ring (in other modes, the shutter-release will be disabled). The camera exposure meter and a variety of other features can not be used (📷 97).

🔧 10—ISO Auto (📷 76)

Use this option to enable auto ISO sensitivity control in P, S, A, and M modes.

📷 Exposure

The same exposure can be achieved with different combinations of shutter speed and aperture, allowing you to freeze or blur motion and control depth of field. The following figure shows how shutter speed and aperture affect exposure.



Shutter speed



Fast shutter speed



Slow shutter speed



Aperture



Small aperture (large f/-number)



Large aperture (small f/-number)

Mode P (Programmed Auto)

In this mode, the camera automatically adjusts shutter speed and aperture for optimal exposure in most situations. This mode is recommended for snapshots and other situations in which you want to leave the camera in charge of shutter speed and aperture.

To take photographs in programmed auto:

1 Rotate the mode dial to P.

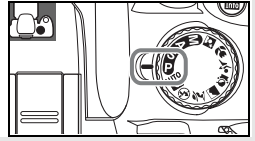

2 Frame a photograph, focus, and shoot.



Flexible Program

In mode P, different combinations of shutter speed and aperture can be selected by rotating the command dial (“flexible program”). Rotate the command dial to the right for large apertures (small f-/numbers) that blur background details or fast shutter speeds that “freeze” motion. Rotate the command dial to the left for small apertures (large f-/numbers) that increase depth of field or slow shutter speeds that blur motion. All combinations produce the same exposure. While flexible program is in effect, a  indicator appears in the viewfinder. To restore default shutter speed and aperture settings, rotate the command dial until the indicator is no longer displayed, choose another mode, or turn the camera off.





Mode S (Shutter-Priority Auto)

In shutter-priority auto, you choose the shutter speed from values between 30s and $\frac{1}{4,000}$ s while the camera automatically selects the aperture that will produce the optimal exposure. Use slow shutter speeds to suggest motion by blurring moving subjects, high shutter speeds to “freeze” motion.

To take photographs in shutter-priority auto:

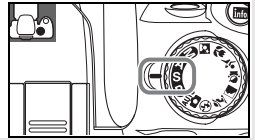
- 1 Rotate the mode dial to S.





- 2 Rotate the command dial until the desired shutter speed is displayed in the viewfinder (shutter speed can also be displayed in the monitor by pressing the  button).



- 3 Frame a photograph, focus, and shoot.

Shutter Speed and Camera Shake

To prevent blur caused by camera shake, the shutter speed should be faster than the inverse of the focal length of the lens, in seconds (for example, when using a lens with a focal length of 300mm, choose a shutter speed faster than $\frac{1}{300}$ s). A tripod is recommended when shooting at slower shutter speeds. To prevent blur, try increasing ISO sensitivity ( 37), using the built-in flash ( 34) or an optional Speedlight ( 99), mounting the camera on a tripod, or using a vibration reduction (VR) lens.

Mode A (Aperture-Priority Auto)

In aperture-priority auto, you choose the aperture from values between the minimum and maximum for the lens while the camera automatically selects the shutter speed that will produce the optimal exposure. Small apertures (high f/-numbers) increase depth of field, bringing both the main subject and background into focus. Large apertures (low f/-numbers) soften background details.

To take photographs in aperture-priority auto:

- 1 Rotate the mode dial to A.

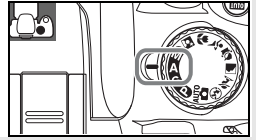

- 2 Rotate the command dial until the desired aperture is displayed in the viewfinder (aperture can also be displayed in the monitor by pressing the  button).



- 3 Frame a photograph, focus, and shoot.

Mode M (Manual)

In manual exposure mode, you control both shutter speed and aperture. Shutter speed can be set to values between 30s and 1/4,000s, or the shutter can be held open for indefinitely for longer exposures (**b u l b**). Aperture can be set to values between the minimum and maximum values for the lens.

To take photographs in manual exposure mode:

- 1 Rotate the mode dial to M.

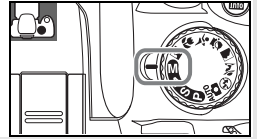

- 2 Rotate the command dial to choose a shutter speed (see the illustration at left, below). To set aperture (below right), rotate the command dial while pressing the **Pz** (**Ⓢ**) button (to display shutter speed and aperture in the monitor, press the **Info** button). Check exposure in the electronic analog exposure displays (see note below).

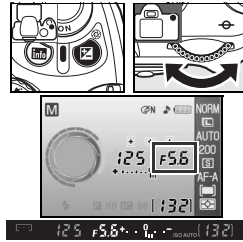
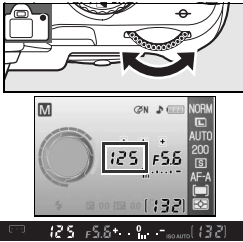

- 3 Frame a photograph, focus, and shoot.

Electronic Analog Exposure Display

If a CPU lens is attached and a shutter speed other than **b u l b** is selected, the electronic analog exposure displays in the viewfinder and shooting information display show whether the photograph would be under- or over-exposed at current settings. If the limits of the exposure metering system are exceeded, the displays will flash.

Display	Description
+ . 0 . .-	Optimal exposure
+ . 0 . .-	If indicator is to right of 0, picture will be underexposed. Display at left indicates that picture will be underexposed by 1/3EV.
+ 0 . .-	If indicator is to left of 0, picture will be overexposed. Display at left indicates that picture will be overexposed by more than 2EV.

Long Time-Exposures

Shutter speeds of "bulb" and "--" can be used for long time-exposure photographs of moving lights, the stars, night scenery, or fireworks. To prevent blurring caused by camera shake, use a tripod or an optional remote control (📷 33, 103).

Shutter speed	Description
---------------	-------------

bulb	Shutter remains open while the shutter-release button is held down.
--	Optional remote control required. Select mode M , choose a shutter speed of "bulb," and then select delayed remote or quick-response remote mode (📷 33). Shutter opens when the shutter-release button on the remote control is pressed and remains open for thirty minutes or until the button is pressed a second time.



35s, f/25



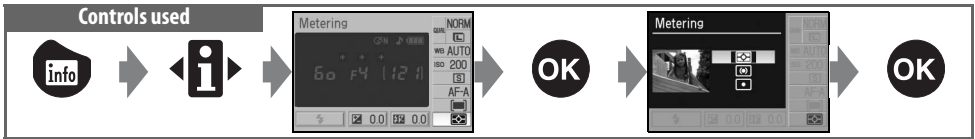

To prevent loss of power before the exposure is complete, use a fully charged battery or an optional AC adapter. Note that noise may be present in long exposures; before shooting, choose **On** for the **Noise reduction** option in the shooting menu.

Exposure

Metering



The metering method determines how the camera sets exposure. The following options are available when the mode dial is rotated to **P**, **S**, **A**, or **M** (matrix metering is used in other modes):

Method	Description
 Matrix	Recommended in most situations. Camera meters a wide area of the frame and instantly sets exposure according to distribution of brightness, color, distance, and composition for natural results.
 Center-weighted	Camera meters entire frame but assigns greatest weight to center area. Classic meter for portraits.
 Spot	Camera meters exposure in active focus area only (if Closest subject is selected for AF-area mode  24), camera will meter center focus area). Ensures that subject will be correctly exposed, even when background is much brighter or darker.

Metering

Metering is available with CPU lenses only. In matrix metering, exposure is set using a 420-segment RGB sensor. Use a type G or D lens for results that include range information (*3D color matrix metering II*;  97). With other CPU lenses, 3D range information is not included (*color matrix metering II*).

CPU lenses can be identified by the presence of CPU contacts, type G and D lenses by a letter on the lens barrel. Type G lenses are not equipped with a lens aperture ring.

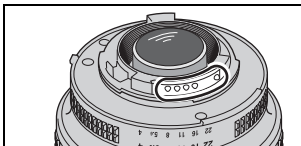

CPU lens

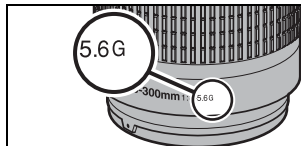

Type G lens

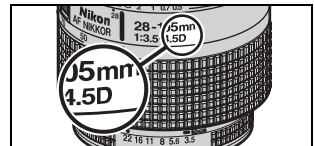

Type D lens

5—Metering

Metering can also be selected from the Custom Settings menu.

Autoexposure Lock

Controls used

AE-L/AF-L button

If the subject is not in the metered area when center-weighted or spot metering is used, exposure will be based on lighting conditions in the background and the main subject may not be correctly exposed. This can be prevented by using autoexposure lock.

1 Select mode **P**, **S**, or **A** and choose center-weighted or spot metering (exposure lock has no effect in mode **M**).

2 Position the subject in the selected focus area (when using center-weighted metering, position the subject in the center focus area). Press the shutter-release button halfway and confirm that the in-focus indicator (●) appears in the viewfinder. Then, keeping the shutter-release button pressed halfway and the subject positioned in the selected focus area, press the **AE-L/AF-L** button to lock exposure.

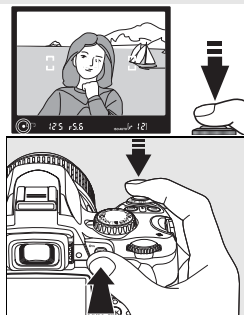

While exposure lock is in effect, an **EL** indicator will appear in the viewfinder.

3 Keeping the **AE-L/AF-L** button pressed, recompose the photograph and shoot.



Adjusting Shutter Speed and Aperture

While exposure lock is in effect, the following settings can be adjusted without altering the metered value for exposure.

Mode	Setting
Programmed auto	Shutter speed and aperture (flexible program;  40)
Shutter-priority auto	Shutter speed
Aperture-priority auto	Aperture

The new values can be confirmed in the viewfinder and shooting information display. Note that the metering method can not be changed while exposure lock is in effect (changes to metering take effect when the lock is released).

12 — AE-L/AF-L (77)

This option controls the behavior of the AE-L/AF-L button.

13 — AE Lock (77)

This option controls whether the shutter-release button locks exposure.

Exposure Compensation

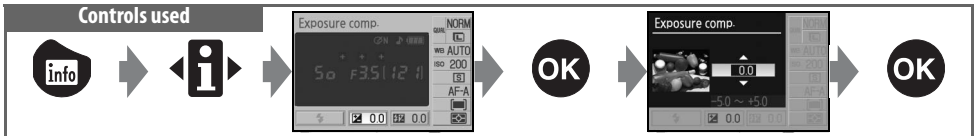

Exposure compensation is used to alter exposure by up to ± 5 EV in increments of $\frac{1}{3}$ EV, making pictures brighter or darker. It is available only in **P**, **S**, **A**, and **M** modes and is most effective when used with center-weighted or spot metering (45). As a rule of thumb, positive compensation may be needed when the main subject is darker than the background, negative values when the main subject is brighter than the background.

Exposure compensation is shown in the shooting information display. Normal exposure can be restored by setting exposure compensation to ± 0 . Exposure compensation is not reset when the camera is turned off.

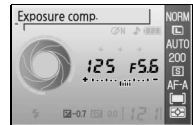

-1 EV



No exposure compensation



+2 EV

The Button

Exposure compensation can also be adjusted by pressing the button and rotating the command dial until the desired value is shown in the viewfinder or shooting information display (**P**, **S**, and **A** modes only). The viewfinder display is illustrated at right.

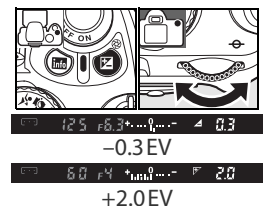

Flash Compensation

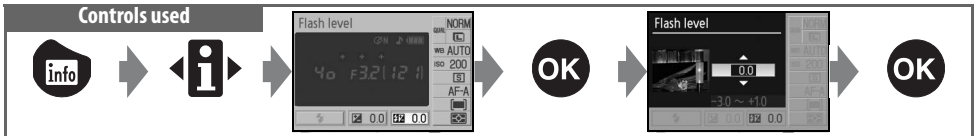



Flash compensation (available only in P, S, A, and M modes) is used to alter flash output by from -3EV to $+1\text{EV}$ in increments of $\frac{1}{3}\text{EV}$, changing the brightness of the main subject relative to the background. Flash output can be increased to make the main subject appear brighter, or reduced to prevent unwanted highlights or reflections.

Flash compensation is shown in the shooting information display. Normal flash output can be restored by setting flash compensation to ± 0.0 . Flash exposure compensation is not reset when the camera is turned off.



The Button

Flash compensation can also be adjusted by pressing the   and  buttons and rotating the command dial until the desired value is shown in the viewfinder or shooting information display. The viewfinder display is illustrated at right.

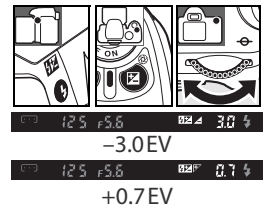





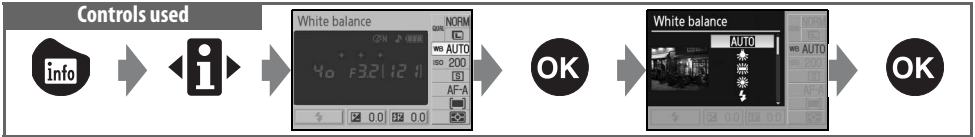

8 — Flash Level (76)

Flash compensation can also be adjusted from the Custom Settings menu.

White Balance



White balance ensures that colors are unaffected by the color of the light source. Auto white balance is recommended for most light sources; if necessary, other values can be selected according to the type of source. The following options are available in **P**, **S**, **A**, and **M** modes (**Auto** is automatically selected in Digital Vari-Program modes):

Option	Description
AUTO Auto	Camera sets white balance automatically. Recommended for most situations.
 Incandescent	Use under incandescent lighting.
 Fluorescent	Use under fluorescent lighting.
 Direct sunlight	Use with subjects lit by direct sunlight.
 Flash	Use with built-in flash or optional Nikon flash units.
 Cloudy	Use in daylight under overcast skies.
 Shade	Use in daylight with subjects in the shade.
PRE White balance preset	Use gray or white object or existing photograph as reference for white balance ( 70).

White Balance (70)

In addition to selecting white balance, the **White balance** option in the shooting menu can be used to fine tune white balance, measure preset white balance, or copy a value for preset white balance from an existing photograph.

11— Fn Button (77)

White balance can also be set using the command dial.







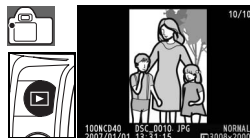













More on Playback

Viewing Photographs on the Camera

To play photographs back, press the  button. The most recent photograph will be displayed in the monitor. Photographs taken in “tall” (portrait) orientation are displayed in tall orientation as shown at right.



The following operations can be performed in full-frame playback:

To	Use	Description
View additional photographs	 or 	Press multi selector to right or rotate command dial right to view photographs in order recorded. Press multi selector left or rotate command dial left to view photographs in reverse order.
View photo information		Press multi selector up or down to view information about current photograph ( 51).
Zoom in on photo		Zoom in on current photograph ( 53).
Delete photo		Delete current photograph ( 54).
Protect photo	 ()	Protect current photograph ( 54).
View thumbnails		View multiple photographs ( 52).
Exit to shooting mode	Shutter button or 	To return to shooting mode, press shutter-release button halfway or press the  button.
View menus		View menus ( 63).
Retouch photo		Create retouched copy of current photograph ( 89).
Display shooting information		Display shooting information ( 22).

Auto Image Rotation (88)/Rotate Tall (66)

These options control whether photographs taken in “tall” orientation are rotated for display in the monitor during playback.

7 — Image Review (75)

Choose whether to display photographs as they are taken.

15 — Auto Off Timers (78)

Choose how long the monitor remains on before turning off automatically to save power.

Photo Information

Photo information is superimposed on images displayed in full-frame playback. Press the multi selector up or down to cycle through the following information: File Information ↔ Shooting Data Page 1 ↔ Shooting Data Page 2 ↔ Retouch History (retouched copies only) ↔ Highlights ↔ RGB Histogram ↔ File Information.

File Information

1 Protect status.....	54	5 File name.....	31
2 Retouch indicator.....	89	6 Image quality.....	30
3 Frame number/total number of images		7 Date of recording.....	11, 83
4 Folder name.....	85	8 Time of recording.....	11, 83
		9 Image size.....	30

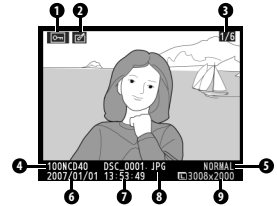

Shooting Data, Page 1

1 Protect status.....	54	7 Mode.....	4
2 Retouch indicator.....	89	8 Exposure compensation.....	47
3 Camera name		9 Focal length.....	1
4 Metering.....	45	10 Flash mode.....	35
5 Shutter speed.....	39-44	11 Frame number/total number of images	
6 Aperture.....	39-44		

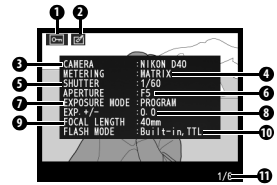

Shooting Data, Page 2

1 Protect status.....	54	7 Tone compensation.....	69
2 Retouch indicator.....	89	8 Sharpening.....	69
3 Image optimization.....	68	9 Color mode/hue.....	69
4 ISO sensitivity ¹	37	10 Saturation.....	69
5 White balance/white balance fine tuning.....	49, 70	11 Image comment ²	84
6 Image size/ image quality.....	30	12 Frame number/total number of images	

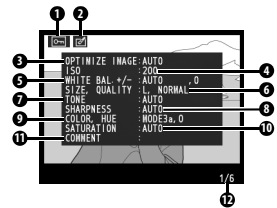

1. Displayed in red if ISO sensitivity was modified from selected value by auto ISO.

2. Only first 15 letters are displayed.

Retouch History¹

1 Protect status.....	54
2 Retouch indicator.....	89
3 Retouch history: Lists changes made to image using options in retouch menu (89), starting with most recent change.	
4 Frame number/total number of images	

1. Displayed if image was created using options in retouch menu.

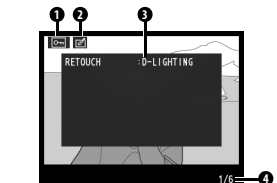

Highlights

Highlights are the brightest portions of the image. Details may be lost (“washed out”) in areas of highlights that are overexposed.

- 1 Protect status 54
- 2 Retouch indicator 89
- 3 Highlights (indicated by flashing border)
- 4 Frame number/total number of images

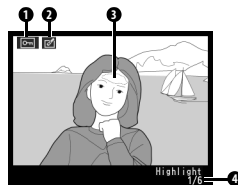

Histogram

A *histogram* is a graph showing the distribution of tones in the image. The horizontal axis corresponds to pixel brightness, with dark pixels at the left and bright pixels at the right. The vertical axis shows the number of pixels of each brightness in the image. Note that camera histograms are intended as a guide only and may differ from those displayed in imaging applications.

- 1 Protect status 54
- 2 Retouch indicator 89
- 3 Frame number/total number of images
- 4 Histogram

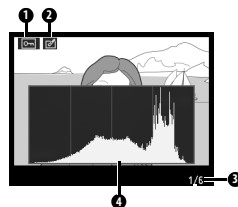

Viewing Multiple Images: Thumbnail Playback

To display images in “contact sheets” of four or nine images, press the button in full-frame playback. The following operations can be performed while thumbnails are displayed:





















To	Use	Description
Display more images per page		Increase number of images displayed from one (full-frame playback) to four or from four to nine.
Display fewer images per page		Decrease number of images displayed from nine to four or from four to one (full-frame playback).
View photo		View highlighted photograph full frame.
Highlight photographs	or	Use multi selector or command dial to highlight photographs.
Delete photo		Delete highlighted photograph (54).
Protect photo	()	Protect highlighted photograph (54).
Exit to shooting mode	Shutter button or	To return to shooting mode, press shutter-release button halfway or press the button.
View menus		View menus (63).
Display shooting information		Display shooting information (22).

Taking a Closer Look: Playback Zoom

Press the  button to zoom in on a photograph in full-frame playback. The following operations can be performed:



To	Use	Description
Zoom in and out	 	Press  to zoom in to maximum of approximately 19× (large images), 15× (medium images) or 10× (small images). Press  to zoom out. While photo is zoomed in, press multi selector up, down, left, or right to view areas of image not visible in monitor. Keep multi selector pressed to scroll rapidly to other areas of frame. Navigation window is displayed when zoom ratio is altered; area currently visible in monitor is indicated by yellow border.
View other areas of image		
View other images		Rotate command dial to view same location in other images at current zoom ratio.
Cancel zoom		Return to full-frame playback.
Delete photo		Delete current photograph ( 54).
Protect photo	 ()	Protect current photograph ( 54).
Exit to shooting mode	Shutter button or 	To return to shooting mode, press shutter-release button halfway or press the  button.
View menus		View menus ( 63).
Display shooting information		Display shooting information ( 22).



Protecting Photographs from Deletion

In full-frame, zoom, and thumbnail playback, the **AE-L/AF-L** button can be used to protect photographs from accidental deletion. Protected files can not be deleted using the **DEL** button or the **Delete** option in the playback menu, and have DOS “read-only” status when viewed on a Windows computer. Note that protected files *will* be deleted when the memory card is formatted (▶ 13, 81).

Press the **AE-L/AF-L** button to protect the photograph currently displayed in full-frame or zoom playback or highlighted in the thumbnail list. The photograph will be marked with a **LOCK** icon.



To remove protection from the photograph so that it can be deleted, press the **AE-L/AF-L** button when the photograph is displayed in full-frame or zoom playback or highlighted in the thumbnail list.

Deleting Individual Photographs

Press the **DEL** button to delete the photograph currently displayed in full-frame or zoom playback or highlighted in the thumbnail list. One of the following confirmation dialogs will be displayed; press the **DEL** button again to delete the photograph. Press the **DISP** button to exit without deleting the photograph.

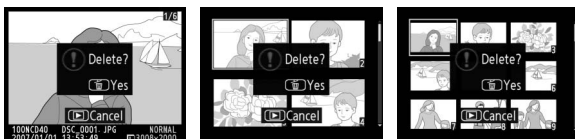
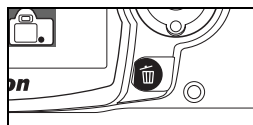

Delete (▶ 65)

This option can be used to delete multiple photographs.

Connecting to a Computer, Printer, or TV

Connecting to a Computer

The camera can be connected to a computer using the supplied USB cable. The supplied PictureProject software can then be used to copy photographs to the computer, where they can be organized, retouched, and printed.

Before Connecting the Camera

Install PictureProject from the supplied installer CD. To ensure that data transfer is not interrupted, be sure the camera battery is fully charged. If in doubt, charge the battery before connecting the camera or use an optional EH-5 AC adapter and EP-5 AC adapter connector (103).

Before connecting the camera, select the **USB** item in the camera setup menu and choose a USB option as described below.

Computer operating system	USB
Windows XP Home Edition Windows XP Professional	Choose PTP or Mass Storage
Mac OS X version 10.3.9 or later	
Windows 2000 Professional	Choose Mass Storage *



* Do NOT select **PTP**. If **PTP** is selected when the camera is connected, the Windows hardware wizard will be displayed. Click **Cancel** to exit the wizard, and then disconnect the camera and select **Mass Storage**.

Connecting the USB Cable

1 Turn the computer on and wait for it to start up.

2 Turn the camera off.

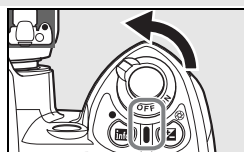

3 Connect the supplied USB cable as shown. Do not use force or attempt to insert the connectors at an angle. Connect the camera directly to the computer; do not connect the cable via a USB hub or keyboard.

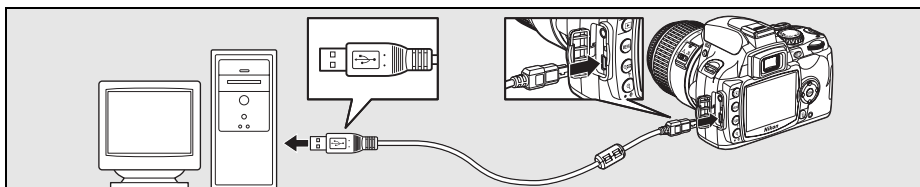

4 Turn the camera on. The computer will detect the camera automatically and display PictureProject Transfer. If **Mass Storage** is selected for **USB**, the monitor and viewfinder will display the indicators shown at right (when **PTP** is selected, the normal shooting indicators are displayed).

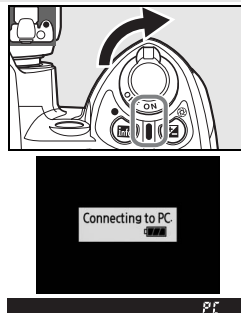

5 Transfer photographs to the computer using PictureProject. See the PictureProject online help for more information.

6 If **PTP** is selected for **USB**, the camera can be turned off and the USB cable disconnected once transfer is complete. If **Mass Storage** is selected, the camera must first be removed from the system as described below.

Windows XP Home Edition/Windows XP Professional

Click the "Safely Remove Hardware" icon in the taskbar (🔌) and select **Safely remove USB Mass Storage Device**.



Windows 2000 Professional

Click the "Unplug or Eject Hardware" icon in the taskbar (🔌) and select **Stop USB Mass Storage Device**.

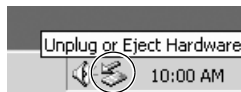

Mac OS X

Drag the camera volume ("NIKON D40") into the Trash.



✓ **During Transfer**

Do not turn the camera off or disconnect the USB cable while transfer is in progress.

📷 **Camera Control Pro**

Camera Control Pro (available separately; 📷 103) can be used to operate the camera from a computer. Before connecting the camera, set the camera **USB** option (📷 84) to **PTP**. When Camera Control Pro is running, the indicators shown at right will appear in the viewfinder and shooting information display.

Printing Photographs

Photographs can be printed by any of the following methods:

- Connect the camera to a printer and print JPEG photographs directly from the camera (see below).
- Insert the camera memory card in a printer equipped with a card slot (see the printer manual for details). If the printer supports DPOF (📷 117), photographs can be selected for printing using **Print set (DPOF)** (📷 61).
- Take the camera memory card to a developer or digital printer center. If the center supports DPOF (📷 117), photographs can be selected for printing using **Print set (DPOF)** (📷 61).
- Transfer pictures (📷 55) and print them from a computer using PictureProject or Capture NX (available separately; 📷 103). Note that this is the only method available for printing RAW (NEF) pictures.

Printing Via Direct USB Connection

JPEG photographs can be printed directly from a camera connected to a PictBridge printer (📷 117). When taking photographs for printing via direct USB connection in P, S, A, and M modes, choose **Ia (sRGB)** or **IIIa (sRGB)** for the **Custom > Color mode** option in the **Optimize image** menu (📷 68).

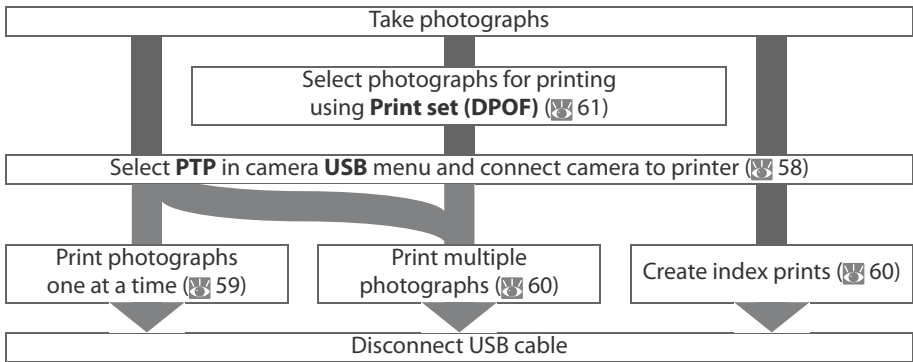

📷 Printing Via Direct USB Connection

If an error occurs during printing, the camera will display the dialog shown at right. After checking the printer, press the multi selector up or down to highlight **Continue** and press OK to resume printing. Select **Cancel** to exit without printing the remaining pages.

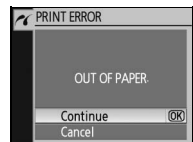

RAW (NEF) photographs can not be printed by direct USB connection. They are displayed in the Print Select menu (📷 60) but can not be selected for printing.

Connecting the Printer

Before printing, check that the camera battery is fully charged. If in doubt, charge the battery or use an EH-5 AC adapter and EP-5 AC adapter connector (available separately;  103).

- 1 Set the camera **USB** option to **PTP**  84).



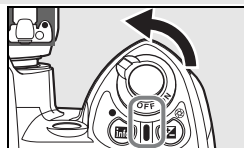

- 2 Turn the printer on.

- 3 Turn the camera off.



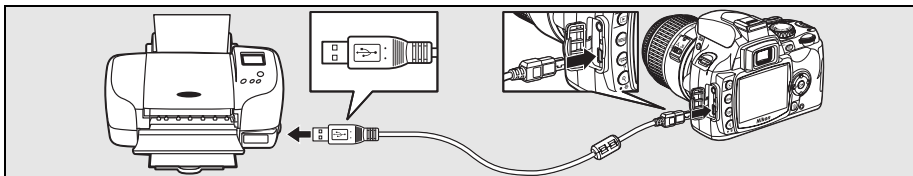



- 4 Connect the supplied USB cable as shown. Do not use force or attempt to insert the connectors at an angle. Connect the camera directly to the printer; do not connect the cable via a USB hub or keyboard.

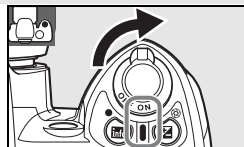

- 5 Turn the camera on. A welcome screen will be displayed, followed by the PictBridge playback display. Proceed to “Printing Pictures One at a Time”  59) or “Printing Multiple Pictures”  60).



Press the multi selector left or right to view additional photographs, or press the  button to zoom in on the current photo  53). To view six photographs at a time, press the  button. Use the multi selector to highlight photographs, or press  to display the highlighted photograph full frame.

Printing Pictures One at a Time

To print the picture currently selected in the PictBridge playback display, press **OK**. The menu shown at right will be displayed. Press the multi selector up or down to highlight an option and press to the right to select.

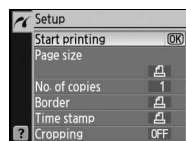

Option	Description	
Page size	Menu shown at right will be displayed. Press multi selector up or down to choose page size from Printer default (default page size for current printer), 3.5x5 in. , 5x7 in. , 100x150mm , 4x6 in. , 8x10 in. , Letter , A3 , or A4 , then press OK to select and return to print menu.	
No. of copies	Menu shown at right will be displayed. Press multi selector up or down to choose number of copies (maximum 99), then press OK to select and return to print menu.	
Border	Menu shown at right will be displayed. Press multi selector up or down to choose print style from Printer default (default for current printer), Print with border (print photo with white border), or No border , then press OK to select and return to print menu.	
Time stamp	Menu shown at right will be displayed. Press multi selector up or down to choose Printer default (default for current printer), Print time stamp (print time and date of recording on photo), or No time stamp , then press OK to select and return to print menu.	
Cropping	Menu shown at right will be displayed. To exit without cropping picture, highlight No cropping and press OK . To crop picture, highlight Crop and press multi selector right. If Crop is selected, dialog shown at right will be displayed. Use Q and Q buttons to choose size of crop and use multi selector to choose position of crop. Press OK to return to print menu.	

To start printing, highlight **Start printing** and press **OK**. The PictBridge playback display will be shown when printing is complete.

Page Size, Border, and Time Stamp

Choose printer default to print at current printer settings. Only options supported by the current printer can be selected.

Printing Multiple Pictures

To print multiple pictures or create an index print listing all JPEG photographs as small thumbnail images, press the **MENU** button in the PictBridge playback display. The menu shown at right will be displayed. Press the multi selector up or down to highlight an option and press to the right to select.

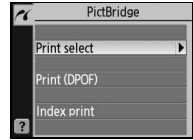

Option	Description
Print select	Print selected pictures (see below).
Print (DPOF)	Print current DPOF print order (61).
Index print	Create index print of all JPEG photos, to maximum of 256. Confirmation dialog shown at right will be displayed; press OK to display menu of print options. Choose page size, border, and time stamp options as described on preceding page (warning will be displayed if selected page size is too small). To start printing, highlight Start printing and press OK . PictBridge menu will be displayed when printing is complete.

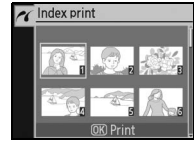

Printing Selected Photographs

Choosing **Print select** displays the menu shown in Step 1.

1

Scroll through pictures. To display current picture full screen, press and hold **OK** button.

2

Select current picture and set number of prints to 1. Selected pictures marked by icon.

3

Specify number of prints (up to 99). To deselect picture, press multi selector down when number of prints is 1. Repeat Steps 1–3 to select additional pictures.

4



Display print options. Choose page size, border, and time stamp options as described on page 59. To start printing, highlight **Start printing** and press **OK**. PictBridge menu will be displayed when printing is complete.

Interrupting Printing

To cancel printing and return to the PictBridge playback display, press **OK**.

Creating a DPOF Print Order: Print Set

The **Print set (DPOF)** option in the playback menu is used to create digital “print orders” for PictBridge-compatible printers and devices that support DPOF. Selecting **Print set (DPOF)** from the playback menu displays the menu shown in Step 1.

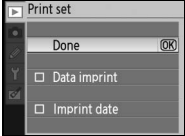
<p>1</p>  <p>Highlight Select / set.</p>	<p>2</p>  <p>Display selection dialog.</p>
<p>3 Select pictures and specify number of prints as described in Steps 1–3 on previous page. Note that RAW (NEF) photos can not be selected for printing.</p>	
<p>4</p>  	<p>Display options. Highlight option and press multi selector right:</p> <ul style="list-style-type: none">• Data imprint: Print shutter speed and aperture on all pictures in print order.• Imprint date: Print date of recording on all pictures in print order. <p>To complete print order and exit, highlight Done and press OK.</p>



To print the current print order when the camera is connected to a PictBridge printer, select **Print (DPOF)** in the PictBridge menu and follow the steps in “Printing Selected Photographs” to modify and print the current order (60). DPOF date and data imprint options are not supported when printing via direct USB connection; to print the date of recording on photographs in the current print order, use the PictBridge **Time stamp** option.

Print Set

The **Print set (DPOF)** option can not be used if there is not enough space on the memory card to store the print order.

Print orders may not print correctly if images are deleted using a computer after the print order is created.

Viewing Photographs on TV

An EG-D100 video cable (available separately;  103) can be used to connect the camera to a television or VCR for playback or recording. Use of an optional EH-5 AC adapter and EP-5 AC adapter connector is recommended for extended playback ( 103).

- 1 Choose the appropriate video mode ( 83).

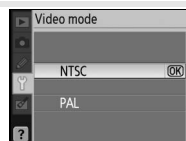

- 2 Turn the camera off. Always turn the camera off before connecting or disconnecting the video cable.

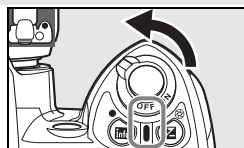

- 3 Connect the video cable as shown.

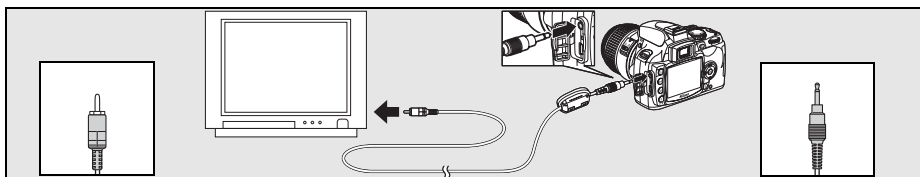

Connect to video device

Connect to camera

- 4 Tune the television to the video channel.

- 5 Turn the camera on and press  to begin playback. During playback, images will be displayed on the television or recorded to video tape; the camera monitor will remain off.

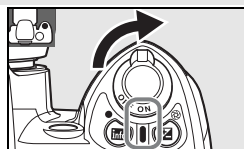

Menu Guide

Using Camera Menus

Most shooting, playback, and setup options can be accessed from the camera menu. To view the menu, press the **MENU** button.



Choose from playback, shooting, Custom Settings, setup, and retouch menus (see below)

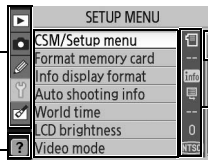

Slider shows position in current menu

If “?” icon is displayed, help for the current item can be viewed by pressing **INFO** button

Current setting for each option is shown by icon

Current menu item is highlighted

Menu	Description
Playback	Adjust playback settings and manage photos (P. 65).
Shooting	Adjust shooting settings (P. 68).
Custom Settings	Personalize camera settings (P. 74).
Setup	Format memory cards and perform basic camera setup (P. 80).
Retouch	Create retouched copies of existing photographs (P. 89).

The multi selector and OK button are used to navigate the camera menus.

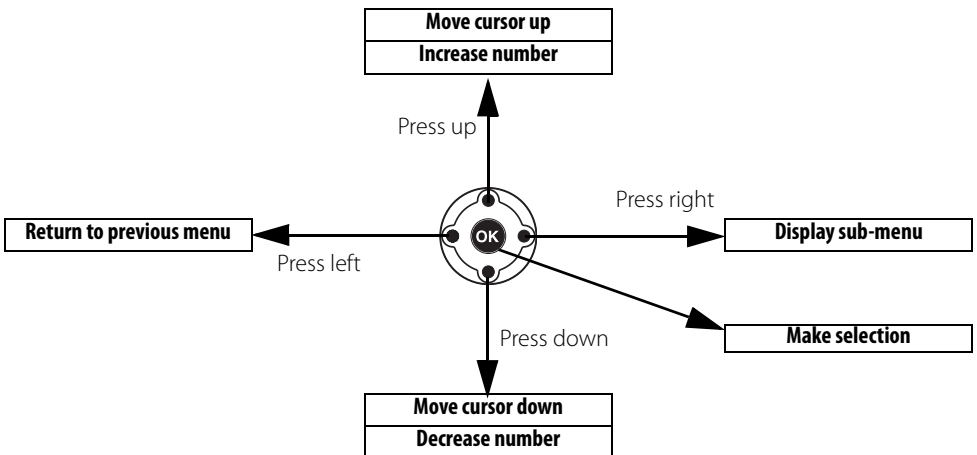

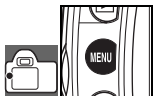

To modify menu settings:

- 

Display menus.
- 

Highlight icon for current menu.
- 

Select menu.
- 

Position cursor in selected menu.
- 

Highlight menu item.
- 

Display options.
- 

Highlight option.
- 

Make selection.

Menu items that are displayed in gray are not currently available.

Press the shutter-release button halfway to exit the menus and return to shooting mode. The monitor will turn off.

Playback Options: The Playback Menu

The playback menu contains the following options (options displayed may differ if **My menu** is selected for the **CSM/Setup menu** option in the setup menu; 80). See “Using Camera Menus” (63) for more information on using the menus.

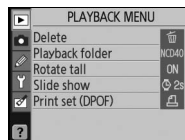

Option	Description	
Delete	Delete all or selected photos.	65
Playback folder	Choose folder for playback.	66
Rotate tall	Rotate “tall” (portrait-orientation) photos during playback.	66
Slide show	Play photos back in automatic slide shows.	67
Print set (DPOF)	Select photos for printing.	67

Delete

The delete menu contains the following options:

Option	Description
Selected	Delete selected photographs (see below).
All	Delete all photographs.

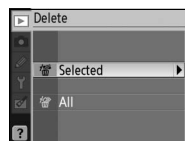

Selecting Multiple Pictures

To select multiple pictures for deletion:

1		
<p>Highlight picture. To view highlighted picture full frame, press button.</p>		
2		
<p>Select highlighted picture. Selection shown by icon.</p>		
3	<p>Repeat steps 1–2 to select additional pictures. To deselect picture, highlight and press multi selector down.</p>	
4		
<p>Complete operation.</p>		

Playback Folder

Choose a folder for playback:

Option	Description
Current (default)	Only photos in the folder currently selected for Folders in the setup menu are displayed during playback. This option is selected automatically when a photo is taken. If a memory card is inserted and this option selected before photos have been taken, a message stating that the folder contains no images will be displayed during playback. Select All to begin playback.
All	Play back photos in all folders on the memory card.

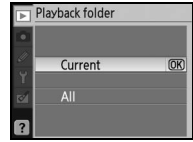

Rotate Tall

Select **On** to rotate "tall" (portrait-orientation) photos for display in the camera monitor. Photographs taken with **Off** selected for **Auto image rotation** (📷 88) will be displayed in "wide" (landscape) orientation.

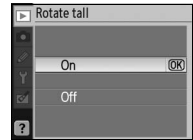

Slide Show

Create a slide show of the pictures in the current playback folder. The following options are available:

Option	Description
Frame interval	Choose how long each picture will be displayed.
Start	Start slide show.

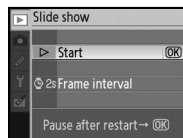

The following operations can be performed during a slide show:

To	Use	Description
Skip back/skip ahead		Press multi selector left to return to previous frame, right to skip to next frame.
View photo info		Change photo info displayed.
Pause slide show		Pause slide show.
Exit to playback menu		End slide show and return to playback menu.
Exit to playback mode		End slide show and return to full-frame (50) or thumbnail playback (52).
Exit to shooting mode	Shutter release	Press shutter-release button halfway to return to shooting mode.
Display shooting information		Display shooting information (22).

The dialog shown at right is displayed when the show ends or when the button is pressed to pause playback. Select **Restart** to restart the show or **Exit** to return to the playback menu.



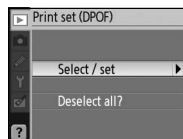

Print Set (DPOF)

Choose **Select/set** to select photographs for printing on a Pict-Bridge printer or DPOF-compatible device (57). Choose **Deselect all?** to remove all photos from the current print order.



Shooting Options: The Shooting Menu

The shooting menu contains the following options (options displayed may differ if **My menu** is selected for the **CSM/Setup menu** option in the setup menu;  80). See “Using Camera Menus” ( 63) for more information on using the menus.

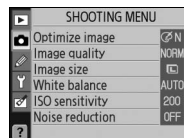









Option	Description	
Optimize image*	Optimize images according to scene.	68–69
Image quality	Choose image quality.	70
Image size	Choose image size.	70
White balance*	Adjust colors according to the light source.	70
ISO sensitivity	Raise sensitivity when lighting is poor.	73
Noise reduction	Reduce noise.	73

* Available in P, S, A, and M modes only.

Optimize Image (P, S, A, and M Modes)

Optimize contrast, sharpening, and other settings according to how photographs will be used or the type of scene.

Option	Description
 Normal (default)	Recommended for most situations.
 Softer	Softens outlines, producing natural results suitable for portraits or retouching on a computer.
 Vivid	Enhances saturation, contrast, and sharpness to produce vivid images with vibrant reds, greens, and blues.
 More vivid	Maximizes saturation, contrast, and sharpness to produce crisp images with sharp outlines.
 Portrait	Lowers contrast while lending natural texture and rounded feel to skin of portrait subjects.
 Black-and-white	Take photos in black-and-white.
 Custom	Customize image optimization settings ( 69).

Optimize Image

Use a type G or D lens for best results. Results are optimized for current shooting conditions and vary with exposure and the position of the subject in the frame. For consistent results over a series of photographs, select **Custom** and choose a setting other than **Auto** for image sharpening, tone compensation, and saturation.

Settings other than **Custom** use the sRGB color space.

Color Space

The color space determines the gamut of colors available for color reproduction. sRGB is for general use, while Adobe RGB is used in publishing and commercial printing.

Customizing Image Enhancement Options: Custom

Select **Custom** to make separate adjustments to the following options. After adjusting settings, highlight **Done** and press **OK**.

- **Image sharpening:** Choose how much outlines are sharpened during shooting. Choose high settings for sharp outlines, low settings for softer outlines.

Default setting: Auto.

- **Tone compensation:** Control contrast. Lower settings prevent loss of detail in highlights under harsh lighting or in direct sunlight. Higher settings preserve detail in misty landscapes and other low-contrast subjects. Choose **Custom** to select a user-defined tone curve created using Camera Control Pro (available separately;  103). See the Camera Control Pro manual for details.

Default setting: Auto.

- **Color mode:** Control color reproduction. Photos taken in modes Ia and IIIa are adapted to the sRGB color space and are suited for printing or use “as is,” with no further modification. Choose Ia for portrait shots and IIIa for nature or landscape shots. Mode II is adapted to the Adobe RGB color space, which supports a wider gamut of colors than sRGB. Mode II is the preferred choice for photos that will be extensively processed or retouched.

Default setting: IIIa (sRGB).

- **Saturation:** Control the vividness of colors. Choose **Moderate** for less saturated colors, **Enhanced** for more vivid colors.

Default setting: Auto.

- **Hue adjustment:** Hue can be adjusted between -9° to $+9^\circ$ in increments of 3° (the degrees refer to the “color wheel” often used to express hue). Positive values make reds more orange, greens more blue, and blues more purple. Negative values make reds more purple, blues more green, and greens more yellow.

Default setting: ± 0 .

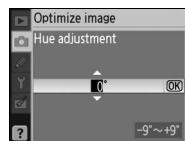
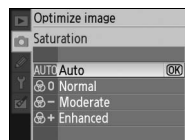
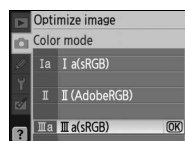
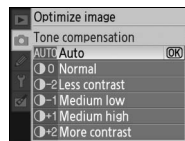
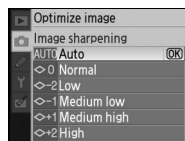

Color Mode

Modes Ia and IIIa are recommended for photos that will be printed without modification or viewed in applications that do not support color management. If the application supports color management, choose the Adobe RGB color space when opening photos taken in mode II.

Image Quality

Select image quality (📷 30).



Image Size

Choose image size (📷 30).

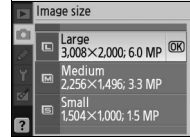

White Balance (P, S, A, and M Modes)

Nine options are available for white balance. See “Reference: White Balance” (📷 49).

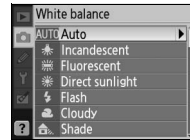

Fine-Tuning White Balance

At settings other than **White balance preset**, white balance can be “fine tuned” by ± 3 in increments of one (see page 118 of the Appendix for color temperature equivalents). Choose lower values to make photographs appear slightly more yellow or red, higher values to lend images a bluish tinge.

Selecting an option other than preset in the white balance menu displays the menu shown at right. Press the multi selector up or down to select a value for fine tuning; press **OK** to select and return to the shooting menu.

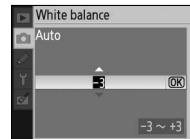

Preset White Balance

Preset white balance can be used when the desired results can not be achieved at other settings or to match white balance to the value used in an existing photograph. Two methods are available for setting preset white balance:

Method	Description
Direct measurement	Neutral gray or white object is placed under lighting that will be used in final photograph and white balance is measured by camera (📷 71).
Copy from existing photograph	White balance is copied from photo on memory card (📷 72).

Measuring a Value for Preset White Balance

1 Place a neutral gray or white object under the lighting that will be used in the final photograph. A standard gray card can be used as a reference in studio settings. Do not alter exposure from the value selected by the camera; when shooting in mode **M**, use the electronic analog exposure display to select optimum exposure.

2 Display the shooting menu and select **White balance** > **White balance preset** (to proceed directly to Step 4 without displaying the shooting menu, select **White balance preset** for white balance in the shooting information display as described on page 49 and press **OK**).

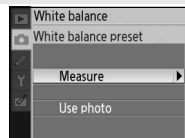

3 Highlight **Measure** and press the multi selector right. The menu shown at right will be displayed; highlight **Yes** and press the multi selector right (to set white balance to the last measured value and exit to shooting mode, highlight **No** and press **OK**).

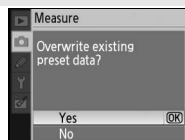

4 The message, "Take photo of white or gray object filling viewfinder under lighting for shooting" will be displayed. When the message clears from the display, the viewfinder and shooting information white balance displays will flash as shown at right. To exit without measuring a preset value, press **MENU** and select another option for white balance.



5 Frame the reference object so that it fills the viewfinder and press the shutter-release button all the way down.



6 If the camera was able to measure a value for white balance, the message "Data acquired" will be displayed. White balance will automatically be set to the measured value; no photograph will be recorded.

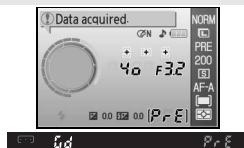

If the warning shown at right is displayed, the camera was unable to measure white balance. Return to Step 2 and measure white balance again.

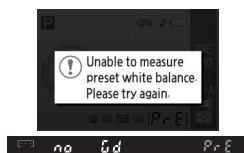

11 — Fn Button (77)

If **White balance** is chosen for Custom Setting 11 (**Fn button**), pressing the **Fn** button for about 2 s when preset white balance is selected will display the indicators shown in Step 4. Measure a value for preset white balance as described in Steps 5–6.

Copying White Balance from a Photograph

A white balance value copied from an existing photograph can be used for preset white balance. Select **White balance** > **White balance preset** in the shooting menu. The menu shown in Step 1 will be displayed.

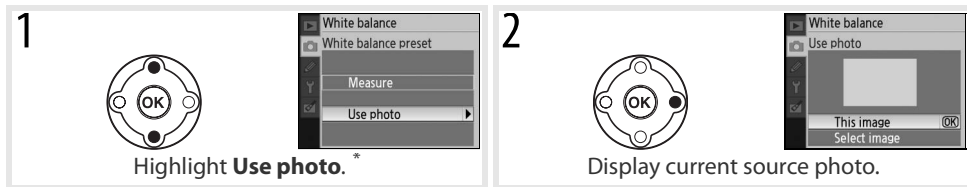

* To use last measured value (71), highlight **Measure** and press multi selector right.

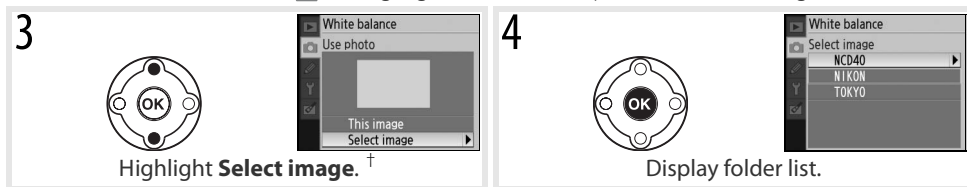

† To use current source photo, highlight **This image** and press OK.

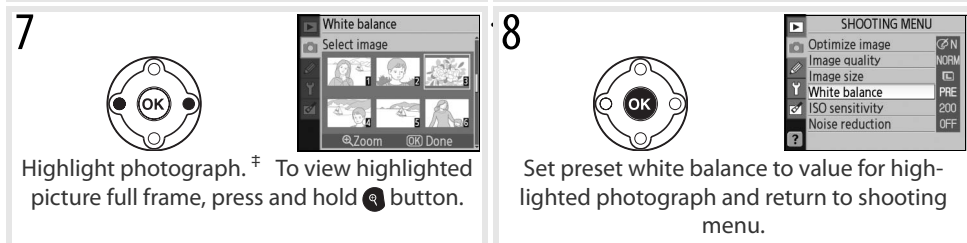
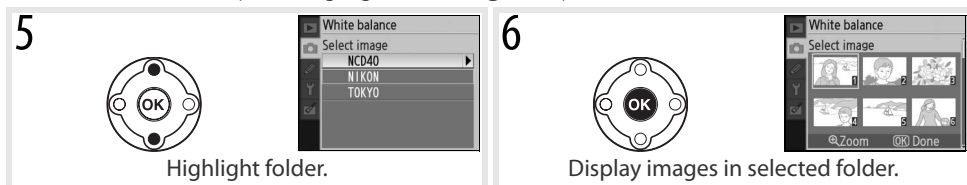

‡ Images displayed may include those created with other cameras, but only photographs created with D40 can be used as source for preset white balance.

Note that if a new value is measured for white balance, white balance will be set to the measured value even if **Use photo** is currently selected in the preset white balance menu.

ISO Sensitivity

Adjust ISO sensitivity (M/37).

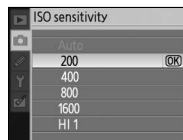

Noise Reduction

Photographs taken at high sensitivities or at shutter speeds of 1 s or slower can be processed to reduce “noise” in the form of mottling or randomly-spaced, brightly-colored pixels. Choose from the following options:

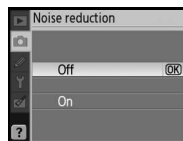

Option	Description
Off (default)	Noise turns off reduction at ISO sensitivities of 1600 or less. Minimal noise reduction is still performed when ISO sensitivity is set to HI 1 .
On	Photographs taken at ISO sensitivities over ISO 800 or at shutter speeds of about 1 s or slower are processed to reduce noise (if shutter speed is 1 s or slower, time need to process photographs before they are recorded approximately doubles and capacity of memory buffer may drop). “Job nr” is displayed at the bottom of the viewfinder during processing. Noise reduction will not be performed if the camera is turned off before processing is complete.

Frame rates will slow if **On** is selected in continuous shooting mode (M/32).



Custom Settings

Custom Settings are used to customize camera settings to suit individual preferences. The following options are available when **Simple** (the default option) is selected for **CSM/Setup menu** in the setup menu (80):

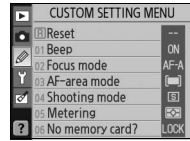

Option	
R Reset	74
1 Beep	74
2 Focus mode	75
3 AF-area mode	75

Option	
4 Shooting mode	75
5 Metering	75
6 No memory card?	75

To display the following options, select **Full** for **CSM/Setup menu**:

Option	
7 Image review	75
8 Flash level	76
9 AF-assist	76
10 ISO auto	76
11 \odot/Fn button	77
12 AE-L/AF-L	77

Option	
13 AE lock	77
14 Built-in flash	78
15 Auto off timers	78
16 Self-timer	79
17 Remote on duration	79

R: Reset

Select **Yes** to restore all Custom Settings to their default values. See the Appendix (113) for a complete list of default settings.

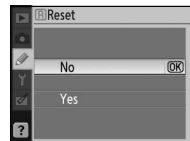

1: Beep

At the default setting of **On**, a beep will sound when the camera focuses in single-servo AF (**AF-S** or when shooting stationary subjects in **AF-A** autofocus mode), while the release timer is counting down in self-timer and delayed remote modes (33), or when a photograph is taken in quick-response remote mode (33). The beep will not sound when **Off** is selected. The current setting is shown in the shooting information display: \mathbb{B} is displayed when the beep is on, \mathbb{C} when it is off (6).



2: Focus Mode

Select a focus mode (🔍 23).

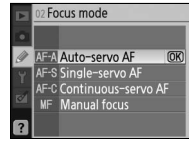

3: AF-Area Mode

Choose how the camera selects the focus area in autofocus mode (🔍 24).



4: Shooting Mode

Select from single-frame, continuous, self-timer, and remote control mode (🔍 32).

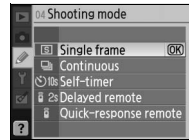

5: Metering (P, S, A, and M Modes Only)

Choose how the camera meters exposure (🔍 45).

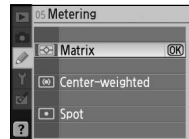

6: No Memory Card?

If **Release locked** (the default setting) is selected, the shutter-release is disabled when no memory card is inserted. Choose **Enable release** to enable the shutter-release button when no memory card is inserted. Photographs will be displayed in the monitor but will not be saved.

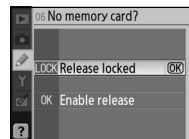

7: Image Review

If **On** (the default setting) is selected, photographs will automatically be displayed in the monitor after shooting (the length of time photographs are displayed depends on the option selected for Custom Setting 15: **Auto off timers**). If **Off** is selected, photographs can be displayed in the monitor by pressing the **Q** button.



8: Flash Level (P, S, A, and M Modes Only)

Adjust flash level (🔧 48).

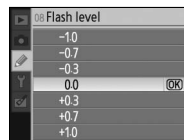

9: AF-assist (All Modes Except 📷 and 🎤)

If **On** (the default setting) is selected and the subject is poorly lit, the AF-assist illuminator will light to assist the focus operation in single-servo AF (**AF-S** or single-servo AF selected in **AF-A** autofocus mode). Choose **Off** to disable the AF-assist illuminator. Note that when the illuminator is off, the camera may not be able to focus on poorly-lit subjects using autofocus.

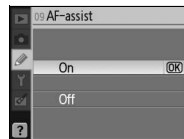

10: ISO Auto (P, S, A, and M Modes Only)

If **Off** (the default setting) is selected, ISO sensitivity will remain fixed at the value selected by the user (🔧 37). If **On** is selected, ISO sensitivity will automatically be adjusted if optimal exposure can not be achieved at the selected value (flash level is adjusted appropriately). The maximum value for auto ISO sensitivity can be selected using the **Max. sensitivity** option. In modes **P** and **A**, sensitivity will only be adjusted if underexposure would result at the shutter speed selected for **Min. shutter speed** (slower shutter speeds may be used if optimal exposure can not be achieved at the value selected for maximum sensitivity).



When **On** is selected, the viewfinder and shooting information display show **ISO-AUTO**. Unless a flash is used, these indicators blink when sensitivity is altered from the value selected by the user. Note that noise is more likely at higher sensitivities.







ISO Auto



Auto ISO control is not available at an ISO sensitivity of **HI 1**. Foreground subjects may be underexposed in photos taken with the flash at slow shutter speeds, in daylight, or against a bright background. Choose a flash mode other than slow sync or select mode **A** or **M** and choose a larger aperture.

11: /Fn Button

Choose the function performed by the Fn button.

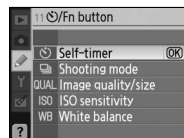
Option	Description
Self-timer (default)	Press the Fn button to select self-timer mode ( 33).
Shooting mode	Press the Fn button and rotate the command dial to select shooting mode ( 32).
Image quality/size	Press the Fn button and rotate the command dial to select image quality and size ( 29).
ISO sensitivity	Press the Fn button and rotate the command dial to select ISO sensitivity ( 37).
White balance	Press the Fn button and rotate the command dial to select white balance (P, S, A, and M modes only;  49).



At settings other than **Self-timer** (the default option), the shooting information display will show a  icon to the left of the setting that can be adjusted by pressing the Fn button and rotating the command dial (“Classic” display only;  81).

12: AE-L/AF-L

Choose the function performed by the AE-L/AF-L button.

Option	Description
AE/AF lock (default)	Both focus and exposure lock while the AE-L/AF-L button is pressed.
AE lock only	Exposure locks while the AE-L/AF-L button is pressed. Focus is unaffected.
AF lock only	Focus locks while the AE-L/AF-L button is pressed. Exposure is unaffected.
AE lock hold	Exposure locks when the AE-L/AF-L button is pressed and remains locked until the button is pressed again or the exposure meters turn off.
AF-ON	The AE-L/AF-L button initiates autofocus. The shutter-release button can not be used to focus.



13: AE Lock

If **Off** (the default option) is selected, pressing the shutter-release button halfway does not lock exposure. If **On** is selected, exposure will lock when the shutter-release button is pressed halfway.

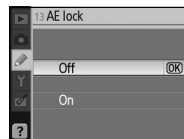

14: Built-in Flash (P, S, A, and M Modes Only)

Choose a flash control mode for the built-in flash or the optional SB-400 Speedlight.

TTL (default): Flash output is adjusted automatically in response to shooting conditions.

Manual: The flash fires at the level selected in the menu shown at right. At full power, the built-in flash has a Guide Number of 18/59 (ISO 200, m/ft., 20°C/68°F).

A  icon flashes in the viewfinder and shooting information display when **Manual** is selected.

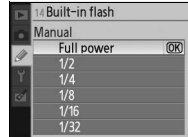
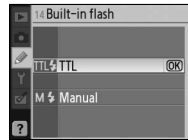



The Optional SB-400 Speedlight

When an optional SB-400 Speedlight is attached, Custom Setting 14 is used to choose the flash control mode for the SB-400 and the name changes to **Optional Speedlight**.

15: Auto off Timers

Choose how long the monitor and exposure meters ( 14) remain on when no operations are performed. Choose a shorter auto off delay for longer battery life.



Option	Description
Short	Monitor and exposure meters remain on for 4s. When Image review is on, pictures are displayed in monitor for 4s after shooting ( 75).
Normal (default)	Monitor and exposure meters remain on for 8s. When Image review is on, pictures are displayed in monitor for 4s after shooting ( 75).
Long	Monitor remains on for 20s; exposure meters remain on for 1 minute. When Image review is on, pictures are displayed in monitor for 20s after shooting ( 75).
Custom	Choose monitor off delay and image review time from 4s, 8s, 20s, 1 minute, and 10 minutes. Choose auto meter-off delay from 4s, 8s, 20s, 1 minute, or 30 minutes.

Note that the shooting information display turns off automatically when the exposure meters turn off.

Using an AC Adapter

Regardless of the setting chosen, the monitor and exposure meters do not turn off automatically when the camera is powered by an optional EH-5 AC adapter and EP-5 AC adapter connector ( 103).

16: Self-Timer

Choose the length of the shutter-release delay in self-timer mode (33). The default setting is 10s.



17: Remote on Duration

Choose how long the camera will wait for a signal from the remote before cancelling delayed or quick-response remote modes (33). Choose shorter times for longer battery life. The default setting is one minute.



Basic Camera Settings: The Setup Menu

The setup menu contains the options listed below (options displayed may differ if **My menu** is selected for **CSM/Setup menu**. See “Using Camera Menus” (63) for more information on using the menus.

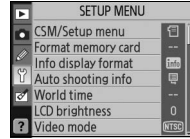

The following options are available when **Simple** (the default option) is selected for **CSM/Setup menu**:

Option	
CSM/Setup menu	80–81
Format memory card	81
Info display format	81–82
Auto shooting info	83
World time	83
LCD brightness	83
Video mode	83
Language	84
Image comment	84
USB	84

To display the following additional options, select **Full** for **CSM/Setup menu**:

Option	
Folders	85
File no. sequence	86
Mirror lock-up	86
Firmware version	86
Dust off ref photo	87
Auto image rotation	88

CSM/Setup menu

Choose the options displayed in the menus.

Option	Description
Simple	Display only basic options in the Custom Settings (74) and (default) setup menus (see above). Other menus list all options.
Full	Display all options.
My menu	Display only selected options.

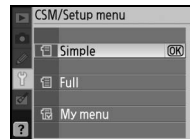

To choose menu items for display with **My menu**:

- 1 Highlight **My menu** and press the multi selector right. A list of menu names will be displayed.
- 2 Highlight a menu name and press the multi selector right. The items in the selected menu will be listed as shown at right (the illustration shows the items listed when the playback menu is selected). The **CSM/Setup menu** item in the setup menu can not be selected.

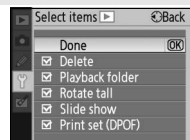
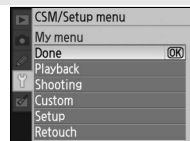

3 Press the multi selector up or down to highlight items and then press to the right to select or deselect. Selected items are indicated by a check mark.

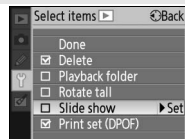

4 Highlight **Done** and press **OK** to return to the list of menu names shown in Step 1. Repeat steps 2–3 to edit additional menus.

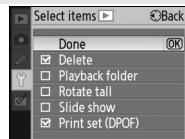

5 Highlight **Done** in the list of menu names and press **OK** to return setup menu.

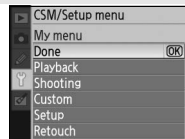

Format Memory Card

Select **Yes** to format the memory card. Note that this permanently deletes all photographs and any other data the card may contain. Be sure that any valued files have been copied to a computer before formatting.



Formatting Memory Cards

Do not turn the camera off or remove the memory card while formatting is in progress.

Info Display Format

Choose one of the following shooting information display formats for Digital Vari-Program (AUTO, P, S, A, M) modes and P, S, A, and M modes.

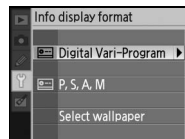

Classic



Graphic



Wallpaper

Classic format is shown below.

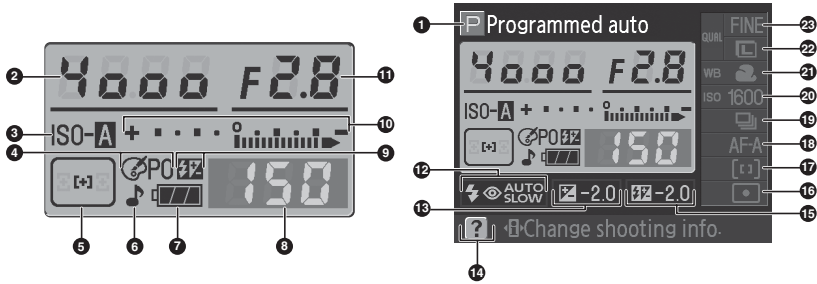

1 Mode.....4	10 Electronic analog exposure display.....43
2 Shutter speed.....39–44	Exposure compensation.....47
3 Auto ISO sensitivity indicator.....76	11 Aperture (f/-number).....39–44
4 Optimize image indicator.....68	12 Flash sync mode.....35
5 Focus area display.....14, 16, 24, 25, 26	13 Exposure compensation value.....47
6 “Beep” indicator.....74	14 Help indicator.....3
7 Battery indicator.....15	15 Flash compensation value.....48
8 Number of exposures remaining.....15, 116	16 Metering mode.....45
Preset white balance recording indicator.....71	17 AF-area mode.....24
PC mode indicator.....56	18 Focus mode.....23
9 Manual flash control indicator.....78	19 Shooting mode.....32
Flash compensation indicator for optional Speedlight.....99	20 ISO sensitivity.....37
	21 White balance mode.....49
	22 Image size.....30
	23 Image quality.....30

The design of the **Wallpaper** format is the same as the **Graphic** display except that a user-selected photograph is displayed in the background, the background color for the menus differs, and the shutter speed and aperture displays are not displayed (6). To choose a photograph for the **Wallpaper** format:



1 Highlight **Select wallpaper** and press the multi selector right. The photographs on the memory card will be displayed as shown at right.







2 Press the multi selector left or right to highlight a photograph. To view the highlighted photograph full screen, press and hold the **Q** button.



3 Press **OK** to select the highlighted picture and return to the setup menu.

Auto Shooting Info

Choose whether to automatically display shooting information in the monitor in Digital Vari-Program (AUTO, , , , and ) modes or P, S, A, and M modes. Select **On** to automatically display shooting information after the shutter-release button is released. If Custom Setting 7 (Image review) is off, shooting information will also be displayed after a photograph is taken. Turn **Auto shooting info** on if you find yourself frequently checking camera settings. Note that even if **On** is selected, the monitor will turn off while the shutter-release button is pressed.

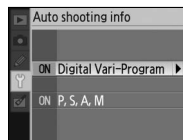

World Time

Set the camera clock to the current date and time.

Option	Description
Time zone	Choose the time zone. The camera clock will automatically be reset to the time in the selected zone.
Date	Set the camera clock ( 11). Reset the clock regularly for accurate time keeping.
Date format	Choose the order in which the month, day, and year are displayed.
Daylight saving time	Turn daylight saving time on or off. The camera clock is automatically advanced or set back one hour.

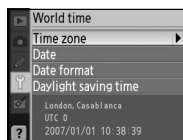

LCD Brightness

Adjust monitor brightness between -2 (darkest) and +2 (brightest).



Video Mode

Choose **NTSC** when connecting the camera to an NTSC television or VCR. Choose **PAL** when connecting the camera to a PAL video device.

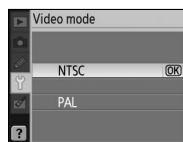

The Clock Battery

The camera clock is powered by an independent, rechargeable power source, which is charged as necessary when the main battery is installed or the camera is powered by an optional EH-5 AC adapter and EP-5 AC adapter connector ( 103). Three days of charging will power the clock for about one month. If "Clock not set" is displayed in the monitor, the clock battery is exhausted and the clock has been reset to a time starting at 2006.01.01.00:00:00. Set the clock to the correct date and time.

Language (LANG)

Choose the language for camera menus and messages from:

De Deutsch	German	Pt Português	Portuguese
En English	English	Ru Русский	Russian
Es Español	Spanish	Sv Svenska	Swedish
Fi Suomi	Finnish	繁 中文 (繁體)	Traditional Chinese
Fr Français	French	简 中文 (简体)	Simplified Chinese
It Italiano	Italian	日 日本語	Japanese
Nl Nederlands	Dutch	한 한글	Korean
Pl Polski	Polish		



Image Comment

Add a comment to photographs as they are taken. Comments can be viewed in Capture NX (available separately; 103) or PictureProject.

- **Done:** Save changes and return to the setup menu.
- **Input comment:** The following dialog will be displayed. Input a comment as described below.

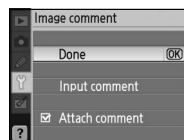
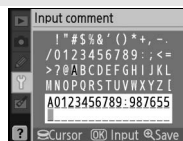

Image Comment

Keyboard area: Use multi selector to highlight letters, press **OK** to select.

Name area: Comment appears here. To move cursor, rotate command dial.



Comments can be up to thirty-six characters long. Any additional characters will be deleted. To delete the character at the current cursor position, press . Press to save changes and return to the image comment menu, or press to exit without changing the comment.

- **Attach comment:** A comment is added to all photographs taken while this option is checked. Highlight this option and press the multi selector to the right to toggle the check mark on or off.

USB

Choose a USB option for connection to a computer or PictBridge printer. Choose **PTP** when connecting to a PictBridge printer or using Camera Control Pro (available separately). See “Connecting to a Computer” for information on selecting a USB option for use with PictureProject (55).



Folders

Create, rename, or delete folders or choose the folder in which new photographs will be stored.

- **Select folder:** Choose the folder in which subsequent photographs will be stored.

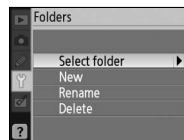
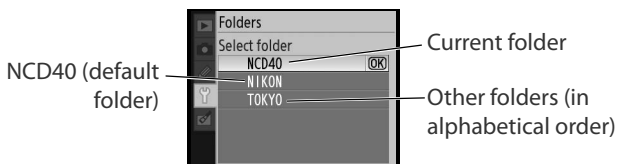

- **New:** Create a new folder and name it as described in “Naming Folders,” below.
- **Rename:** Select a folder from a list and rename it as described in “Naming Folders,” below.
- **Delete:** Delete all empty folders on the memory card.

Naming Folders

Keyboard area: Use multi selector to highlight letters, press **OK** to select.

Name area: Folder name appears here. To move cursor, rotate command dial.

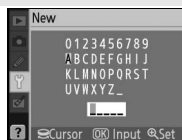

Folder names can be up to five characters long. Any additional characters will be deleted. To delete the character at the current cursor position, press **⏏**. Press **⏏** to save changes and return to the setup menu, or press **⏏** to exit without creating a new folder or changing the folder name.

Folder Names

On the memory card, folder names are preceded by a three-digit folder number assigned automatically by the camera (e.g., 100NCD40). Each folder can contain up to 999 photographs. During shooting, pictures are stored in the highest-numbered folder with the selected name. If a photograph is taken when the current folder is full or contains a photograph numbered 9999, the camera will create a new folder by adding one to the current folder number (e.g., 101NCD40). The camera treats folders with the same name but different folder numbers as the same folder. For example, if the folder NIKON is selected for Select folder, photographs in all folders named NIKON (100NIKON, 101NIKON, 102NIKON, etc.) will be visible when **Current** is selected for **Playback folder** (66). Renaming changes all folders with the same name but leaves the folder numbers intact.

File No. Sequence

Choose how the camera names files.

- **Off** (default): File numbering is reset to 0001 when a new folder is created, the memory card is formatted, or a new memory card is inserted.
- **On**: File numbering continues from the last number used after a new folder is created, the memory card is formatted, or a new memory card is inserted. If a photograph is taken when the current folder contains a photograph numbered 9999, a new folder will be created and file numbering will begin again from 0001.
- **Reset**: As for **On**, except that file numbering is reset to 0001 with the next photograph taken (if the current folder already contains photographs, a new folder will be created).

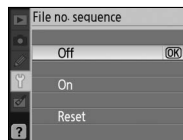

File Numbering

If the current folder is numbered 999 and contains 999 photographs or a photograph numbered 9999, the shutter release will be disabled. If **File no. sequence** is on, turn it off and format the memory card or insert another memory card in the camera.

Mirror Lock-Up

Lock the mirror in the up position when inspecting or cleaning the low-pass filter that protects the camera image sensor ( 105).



Firmware Version

View the current camera firmware version.

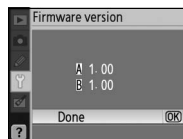

Dust off Ref Photo

Acquire reference data for the Image Dust Off option in Capture NX (available separately; for more information, see the Capture NX manual).



- 1 Highlight **On** and press **OK**. The message shown at right will be displayed.



- 2 With the lens ten centimeters (four inches) from a well-lit, featureless white object, frame the object so that it fills the viewfinder and then press the shutter-release button halfway. In autofocus mode, focus will automatically be set to infinity; in manual focus mode, set focus to infinity manually.

- 3 Press the shutter-release button the rest of the way down to acquire Image Dust Off reference data. The monitor turns off when the shutter-release button is pressed.

If the reference object is too bright or too dark, the camera may be unable to acquire Image Dust Off reference data and the message shown at right will be displayed. Choose another reference object and repeat the process from Step 1.

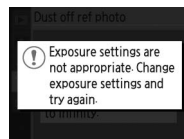
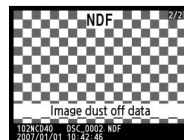

Image Dust Off

Dust off ref photo is available with CPU lenses only. A lens with a focal length of at least 50mm is recommended. If using a zoom lens, zoom all the way in.

The same reference image can be used for photographs taken with different lenses or at different apertures. Reference images can not be viewed using computer imaging software. A grid pattern is displayed when reference images are viewed on the camera.

Image Dust Off is used to reduce the effects of dust in NEF (RAW) photographs. See the Capture NX manual for more information.



Auto Image Rotation

Photographs taken while **On** (the default option) is selected contain information on camera orientation, allowing them to be rotated automatically during playback (▶ 50) or when viewed in Capture NX (available separately; ▶ 103) or PictureProject.* The following orientations are recorded:

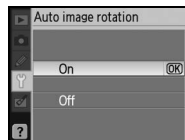

Landscape (wide)
orientation



Camera rotated 90°
clockwise



Camera rotated 90°
counter-clockwise

* In continuous mode (▶ 32), orientation recorded for first shot applies to all images in same burst, even if camera orientation is changed during shooting.

Camera orientation is not recorded when **Off** is selected. Choose this option when taking photographs with the lens pointing up or down.

Creating Retouched Copies: The Retouch Menu

The options in the retouch menu are used to create trimmed, resized, or retouched copies of the photographs on the memory card. The following options are available (options displayed may differ if **My menu** is selected for the **CSM/Setup menu** option in the setup menu; 80). See “Using Camera Menus” (63) for more information on using the menus.

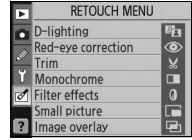

Option	Description	
D-lighting*	Brighten dark or back-lit subjects or produce effects similar to the flash.	90
Red-eye correction*	Correct “red-eye” caused by the flash.	91
Trim	Create cropped copies of existing photographs.	91
Monochrome*	Copy pictures in black-and-white, sepia, or cyanotype.	92
Filter effects*	Create copies with color filter effects.	92
Small picture	Create small copies of existing photographs.	92–93
Image overlay	Combine two RAW photographs into a single image.	94–95

* Not available with photographs taken with **Black-and-white** selected for **Optimize image**.

Except in the case of **Image overlay**, the photographs to be retouched can be selected in full-frame playback or from the retouch menu. In full-frame playback:

1

Display photo in full-frame playback (20, 50).

2

Display retouch menu.

3

Highlight menu item.*

4

Display retouch options.†

* **Image overlay** is not available during full-frame playback.

† If sub-menu is displayed, repeat Steps 2–3 to select options from sub-menu. To exit to full-frame playback without creating modified copy, press button.

Retouching Copies

With the exception of images created using **Small picture**, the options in the retouch menu can be applied to existing copies, although this may result in loss of quality. Each retouch option can however only be applied once.

Image Quality

Small picture creates JPEG Fine copies (1:4 compression ratio). **Image overlay** creates copies at the current image quality setting. Other options copy RAW photos as JPEG Fine quality images; save where otherwise noted, copies created from RAW photos are 3,008×2,000 pixels in size.

To create retouched copies from the retouch menu:

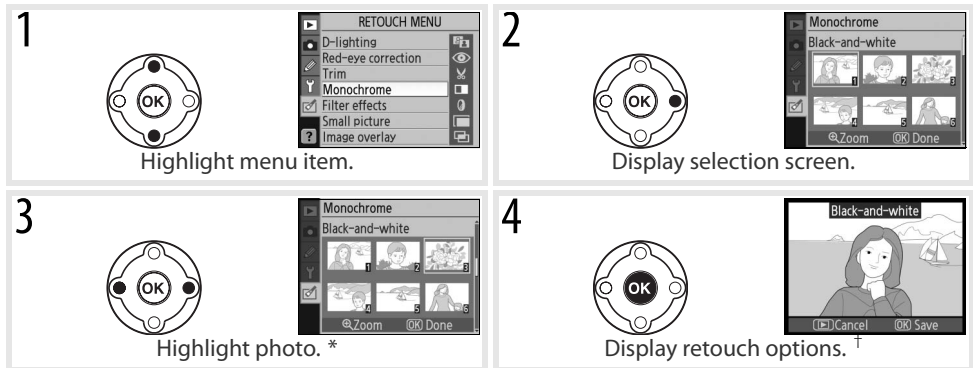

* Photos can also be highlighted using command dial. To view selected picture full frame, press and hold button.

† To exit to playback mode without creating modified copy, press button.

D-Lighting

D-lighting brightens shadows, making it ideal for dark or back-lit photographs.

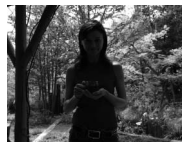

Before



After

Press the multi selector up or down to choose the amount of correction performed. The effect can be previewed in the edit display. Press **OK** to copy the photograph and return to full-frame playback.

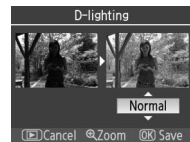

Red-Eye Correction

Selecting this option displays a preview image as shown below. Confirm the effects of red-eye correction and create a corrected copy as described in the following table. Note that red-eye correction may not always produce the expected results and may in very rare circumstances be applied to portions of the image that are not affected by red eye; check the preview thoroughly before proceeding. Red-eye correction is available only with photographs taken using the flash.

To	Use	Description
Zoom in and out		Press to zoom in, to zoom out. While photo is zoomed in, press multi selector up, down, left, or right to view areas of image not visible in monitor. Keep multi selector pressed to scroll rapidly to other areas of frame. Navigation window is displayed while / buttons or multi selector is pressed; area currently visible in monitor is indicated by yellow border.
View other areas of image		
Create copy		If the camera detects red eye in the selected photograph, a copy will be created that has been processed to reduce its effects. No copy will be created if the camera is unable to detect red eye.



Trim

Choosing this option displays the selected image full frame as shown below. To create a cropped copy of the selected image:

To	Use	Description
Zoom in and out		Press to zoom in, to zoom out. While photo is zoomed in, press multi selector up, down, left, or right to view areas of image not visible in monitor.
View other areas of image		
Create copy		Save the area currently visible in the monitor as a separate file and return to full-frame playback.



Trim: Image Quality and Size

Copies created from NEF (RAW) or NEF (RAW)+JPEG photos have an image quality of JPEG Fine; cropped copies created from JPEG photos have the same image quality as the original. Depending on the size of the crop, the copy may be 2,560×1,920, 1,920×1,440, 1,280×960, 960×720, or 640×480 pixels in size.

Monochrome

Choose from **Black-and-white**, **Sepia**, and **Cyanotype** (blue and white monochrome).

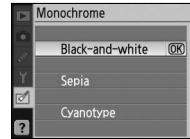

Selecting **Sepia** or **Cyanotype** displays a preview of the selected image; press the multi selector up to increase color saturation, down to decrease. Press **OK** to create a monochrome copy and return to full-frame playback.

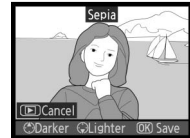

Filter Effects

Choose from the following options. After adjusting filter effects as described below, press **OK** to copy the photograph and return to full-frame playback.

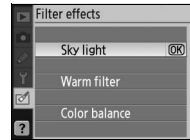

Option	Description
Sky light	Creates the effect of a sky light filter, making the picture less blue. The effect can be previewed in the monitor as shown at right.
Warm filter	Creates a copy with warm tone filter effects, giving the copy "warm" red cast. The effect can be previewed in the monitor.
Color balance	Press the multi selector up to increase the amount of green, right to increase the amount of red, left to increase the amount of blue, or down to increase the amount of magenta. The effect is displayed in the monitor together with red, green, and blue histograms giving the distribution of tones in the copy (52).

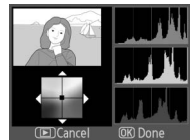











Small Picture

Create a small copy of the selected picture. The following sizes are available:

Option	Description
640×480	Suited to television playback.
320×240	Suited to display on Web pages.
160×120	Suitable for e-mail.

The small picture option can be used during full-frame playback as described on page 89. The procedure for selecting pictures after choosing **Small picture** from the retouch menu, however, differs from that described at the beginning of this section: instead of selecting a single photograph and then choosing a picture size, the user selects a picture size first and then selects one or more photographs to copy at the selected size as described on the following page.

Selecting **Small picture** from the retouch menu displays the menu shown in Step 1. Follow the steps below to create small copies of multiple pictures.

<p>1</p>  <p>Highlight Choose size.</p>	<p>2</p>  <p>Display options.</p>
<p>3</p>  <p>Highlight desired picture size.</p>	<p>4</p>  <p>Make selection and return to previous menu.</p>
<p>5</p>  <p>Highlight Select images.</p>	<p>6</p>  <p>Display selection screen.</p>
<p>7</p>  <p>Select pictures (65). Selected pictures are marked with  icon.</p>	<p>8</p>  <p>Confirmation dialog displayed.</p>
<p>9</p>  <p>Highlight Yes. *</p>	<p>10</p>  <p>Copy photos and exit to full-frame playback.</p>

* To return to Step 7 without creating copies, highlight **No** and press **OK**. Press **MENU** to exit to retouch menu without creating copies.

Viewing Small Pictures

Small pictures are indicated by a gray border during full-frame playback. Playback zoom is not available when small pictures are displayed.

Image Overlay

Image overlay combines two existing RAW photographs to create a single picture that is saved separately from the originals. The new picture is saved at current image quality and size settings; before creating an overlay, set image quality and size (🔍 30; all options are available). To create a RAW image, choose an image quality of **NEF (RAW)**.

- 1 Highlight **Image overlay** in the retouch menu and press the multi selector right. The preview dialog shown at right will be displayed with **Image 1** highlighted.



- 2 Press **OK**. A picture selection dialog will be displayed.

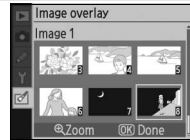

- 3 Press the multi selector left or right to highlight the first photograph in the overlay. To view the highlighted photograph full frame, press and hold the 🔍 button.

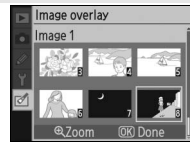

- 4 Press **OK** to select the highlighted image and return to the preview display. The selected image will appear as **Image 1**.

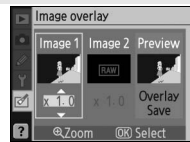

- 5 Optimize exposure for the overlay by pressing the multi selector up or down to select the gain for image 1 from between 0.1 and 2.0. The default value is 1.0; selecting 0.5 cuts gain in half, while selecting 2.0 doubles gain. The effects of gain are visible in the **Preview** column.



- 6 Press the multi selector left or right to highlight **Image 2**. Repeat Steps 2–5 to select the second photo and adjust gain.

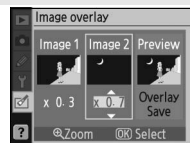

7 Press the multi selector left or right to highlight the **Preview** column. Press the multi selector up or down to highlight one of the following options and press **OK**.

- **Overlay:** Preview the overlay as shown at right. Press **OK** to save the new image. To return to Step 6 and select new photos or adjust gain, press .
- **Save:** Save the overlay without viewing a preview.



After an overlay is created, the camera will enter full-frame playback ( 50) with the new picture displayed in the monitor.

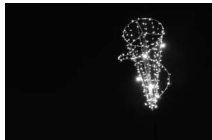

Image Overlay

Only RAW photographs created with the D40 can be selected for image overlay. Other images are not displayed on the selection screen.

The overlay has the same photo info (including date of recording, metering, shutter speed, aperture, exposure mode, exposure compensation, focal length, and image orientation) and values for white balance and optimize image as the photograph selected for **Image 1**.

Technical Notes

Optional Accessories

One advantage of digital SLR cameras is the wide variety of accessories they support. See our web sites or product catalogs for up-to-date information on accessories for the D40.

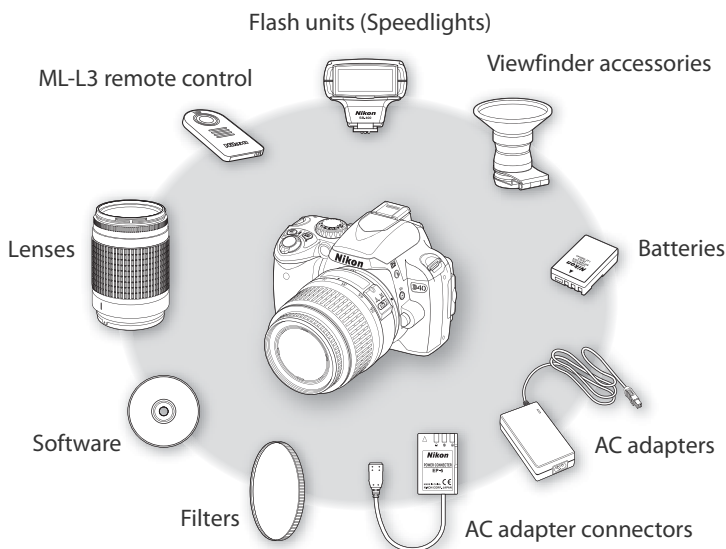

✔ Use Only Nikon Brand Electronic Accessories

Only Nikon brand accessories certified by Nikon specifically for use with your Nikon digital camera are engineered and proven to operate within its operational and safety requirements. THE USE OF NON-NIKON ACCESSORIES COULD DAMAGE YOUR CAMERA AND MAY VOID YOUR NIKON WARRANTY.

👁 Picture Angle and Focal Length

The size of the area exposed by a 35-mm camera is 36×24 mm. The size of the area exposed by the D40, in contrast, is 23.7×15.6 , meaning that the picture angle of a 35-mm camera is approximately 1.5 times that of the D40. The approximate focal length of lenses for the D40 in 35-mm format can be calculated by multiplying the focal length of the lens by about 1.5.

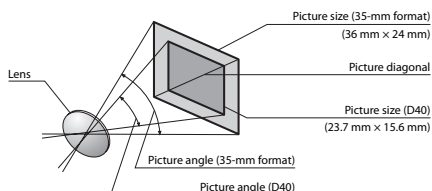

Lenses

Autofocus is supported only with AF-S and AF-I CPU lenses, which are equipped with an autofocus motor. IX Nikkor CPU lenses can not be used; other CPU lenses (including AF lenses not equipped with an autofocus motor) can be used in manual focus mode. CPU lenses can be identified by the presence of CPU contacts (📷 45), AF-S and AF-I lenses by “AF-S” or “AF-I” at the beginning of the lens name.

The following CPU lenses can be used with the D40.

Lens/accessory	Camera setting			Focus		Mode		Metering
	AF	MF (with electronic range finder)	MF	Digital Vari Program, P, S, A	M	📷, 📷, 📷, 📷 ¹		
AF-S, AF-I Nikkor	✓	✓	✓	✓	✓	✓		
PC-Micro Nikkor 85 mm f/2.8D ²	—	✓ ³	✓	—	✓	✓		
AF-S/AF-I teleconverter ⁴	✓ ⁵	✓ ⁵	✓	✓	✓	✓		
Other AF Nikkor (except lenses for F3AF)	—	✓ ⁶	✓	✓	✓	✓		
AI-P Nikkor	—	✓ ⁷	✓	✓	✓	—		

1. Spot metering meters selected focus area.

2. Camera exposure metering and flash control may not function when lens is shifted and/or tilted or aperture is not at maximum.

3. Electronic range finder can not be used when shifting or tilting lens.

4. Compatible with the following lenses:

- **AF-S VR Micro ED:** 105 mm f/2.8G IF (autofocus not supported)
- **AF-S VR ED:** 70–200 mm f/2.8G IF, 200 mm f/2G IF, 300 mm f/2.8G IF, 200–400 mm f/4G IF
- **AF-S ED:** 80–200 mm f/2.8D II IF, 300 mm f/2.8D II IF, 300 mm f/2.8D IF, 300 mm f/4D IF*, 400 mm f/2.8D II IF, 400 mm f/2.8D IF, 500 mm f/4D II IF*, 500 mm f/4D IF*, 600 mm f/4D II IF*, 600 mm f/4D IF*

• **AF-I ED:** 300 mm f/2.8D IF, 400 mm f/2.8D IF, 500 mm f/4D IF*, 600 mm f/4D IF*

* Autofocus not available with TC-17E II/TC-20E II AF-S teleconverter.

5. With maximum effective aperture of f/5.6 or faster.

6. If AF 80–200 mm f/2.8S, 35–70 mm f/2.8S, new-model 28–85 mm f/3.5–4.5S, or 28–85 mm f/3.5–4.5S is zoomed while focusing at minimum range, image on matter screen in viewfinder may not be in focus when in-focus indicator is displayed. Focus manually using image in viewfinder as guide.

7. With maximum aperture of f/5.6 or faster.

📷 Type G and D Lenses

Type G and D AF-S and AF-I CPU lenses (📷 45) are recommended for use with the D40. Type G and D lenses support 3D color matrix metering II (📷 45). Vibration reduction is available with Type G and D VR lenses only.

🔪 Non-CPU Lenses

The non-CPU lenses listed below may be used, but only when the camera is in mode M. Selecting another mode disables the shutter release. Aperture must be adjusted manually via the lens aperture ring; the camera autofocus system, metering, electronic analog exposure display, and TTL flash control can not be used. Except where otherwise noted, the electronic range finder can be used with lenses that have a maximum aperture of f/5.6 or faster.

- AI-modified, AI-, AI-S, or Series E Nikkor
- Medical Nikkor 120 mm f/4 (can only be used at shutter speeds slower than 1/125s)
- Reflex Nikkor (electronic range finder can not be used)
- PC Nikkor (electronic range finder can not be used when shifting or tilting lens)
- AI-type teleconverter*
- PB-6 Bellows focusing attachment (attach in vertical orientation; can be used in horizontal orientation once attached)*
- Auto extension rings (PK 11A, 12, 13; PN-11)*

* Electronic range finder can be used if maximum effective aperture is f/5.6 or faster.

✓ Incompatible Non-CPU Lenses and Accessories

The following non-CPU lenses and accessories can NOT be used:

- TC-16A AF Teleconverter
- Non-AI lenses
- Lenses that require the AU-1 focusing unit (400mm f/4.5, 600mm f/5.6, 800mm f/8, 1200mm f/11)
- Fisheye (6mm f/5.6, 8mm f/8, OP 10mm f/5.6)
- Old-model 21mm f/4
- K2 rings
- ED 180–600mm f/8 (serial numbers 174041–174180)
- ED 360–1200mm f/11 (serial numbers 174031–174127)
- 200–600mm f/9.5 (serial numbers 280001–300490)
- Lenses for the F3AF (80mm f/2.8, 200mm f/3.5, TC-16 Teleconverter)
- PC 28mm f/4 (serial number 180900 or earlier)
- PC 35mm f/2.8 (serial numbers 851001–906200)
- Old-model PC 35mm f/3.5
- Old-model 1000mm f/6.3 Reflex
- 1000mm f/11 Reflex (serial numbers 142361–143000)
- 2000mm f/11 Reflex (serial numbers 200111–200310)

✍ AF-Assist Illumination/Red-Eye Reduction

AF-assist illumination is not available with the following lenses:

- AF-S VR ED 70–200mm f/2.8G
- AF-S ED 80–200mm f/2.8D
- AF-S VR 200mm f/2G
- AF-S VR 300mm f/2.8G
- AF-S VR ED 200–400mm f/4G

At ranges under 1 m (3ft. 3in.), the following lenses may block the AF-assist illuminator and interfere with autofocus when lighting is poor:

- AF-S VR ED 24–120mm f/3.5–5.6G
- AF-S ED 17–35mm f/2.8D
- AF-S DX IF ED 17–55mm f/2.8G
- AF-S ED 28–70mm f/2.8D

Lenses that block the subject's view of the AF-assist illuminator can interfere with red-eye reduction.

✍ The Built-in Flash

The built-in flash can be used with CPU lenses with focal lengths of 18–300mm. The flash may be unable to light the entire subject with the following lenses at ranges less than those given below:

Lens	Zoom position	Min. range
AF-S DX ED 12–24mm f/4G	20mm	3.0m / 9ft. 10in.
	24mm	1.0m / 3ft. 3in.
AF-S ED 17–35mm f/2.8G	24mm	2.0m / 6ft. 7in.
	28mm	1.0m / 3ft. 3in.
	35mm	0.6m / 2ft. 3in.
AF-S DX ED 17–55mm f/2.8G	28mm	1.5m / 4ft. 11in.
	35mm	1.0m / 3ft. 3in.
AF ED 18–35mm f/3.5–4.5D	45–55mm	0.6m / 2ft. 3in.
	24mm	1.0m / 3ft. 3in.
AF-S 18–70mm f/3.5–4.5G	28–35mm	0.6m / 2ft. 3in.
	18mm	1.0m / 3ft. 3in.
AF 20–35mm f/2.8D	24–70mm	0.6m / 2ft. 3in.
	24mm	2.5m / 8ft. 2in.
	28mm	1.0m / 3ft. 3in.
AF-S VR ED 24–120mm f/3.5–5.6G	35mm	0.6m / 2ft. 3in.
	24mm	1.0m / 3ft. 3in.
	28–120mm	0.6m / 2ft. 3in.
AF-S ED 28–70mm f/2.8D	35mm	1.5m / 4ft. 11in.
	50–70mm	0.6m / 2ft. 3in.
AF-S VR ED 200–400mm f/4G	250mm	2.5m / 8ft. 2in.
	300–400mm	2.0m / 6ft. 7in.

Optional Flash Units (Speedlights)

The accessory shoe allows SB-series Speedlights, including the SB-400, 800, 600, 80DX, 28DX, 28, 27, 23, 22S, and 29S to be mounted directly on the camera without a sync cable. It is equipped with a safety lock for Speedlights with a locking pin, such as the SB-800 and SB-600. Before attaching an optional flash unit, remove the accessory shoe cover. The built-in flash will not fire when an optional Speedlight is attached.

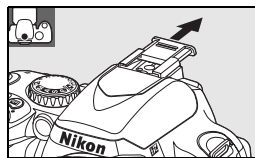

When used with compatible flash units such as the optional SB-400, SB-800, and SB-600 Speedlights or SB-R200 wireless remote Speedlight, the D40 supports the advanced Nikon Creative Lighting System (CLS), including i-TTL flash control and Flash Color Information Communication. See the Speedlight manual for details.

SB-400, SB-800, and SB-600 Speedlights

These high-performance Speedlights have Guide Numbers of 30/98 (18-mm zoom coverage), 53/174 (35-mm zoom head position), and 42/138 (35-mm zoom head position) respectively (m/ft, ISO 200, 20°C/68°F; GNs at ISO 100 are 21/69, 38/125, and 30/98 respectively). The flash head can be rotated through 90° above the horizontal for bounce-flash or close-up photography. The SB-800 and SB-600 can also be rotated 180° left and 90° right, and the SB-800 can be rotated 7° below the horizontal. The SB-800 and SB-600 support auto power zoom (24–105 mm and 24–85 mm, respectively), ensuring that the illuminating angle is adjusted in accord with lens focal length and have both a built-in wide panel that can be used for an angle of 14 mm (the SB-800 also supports 17 mm) and an illuminator that can be used when adjusting settings in the dark.

SB-R200 Wireless Remote Speedlight

This high-performance wireless remote Speedlight has a Guide Number of 14/49 (m/ft, ISO 200, 20°C/68°F; GN at ISO 100 is 10/32). Although it can not be mounted directly on the accessory shoe, it can be controlled using an optional SB-800 Speedlight or SU-800 wireless Speedlight commander. The SB-R200 can be hand-held, placed on an AS-20 Speedlight stand, or mounted on the camera lens using the SX-1 attachment for remote control and close-up i-TTL photography.

SU-800 Wireless Speedlight Commander

The SU-800 can be used as a commander for remote SB-800, 600, or R200 flash units. The SU-800 itself is not equipped with a flash.

Guide Number

To calculate the range of the flash at full power, divide the Guide Number by the aperture. For example, at ISO 200 the SB-400 has a Guide Number of 30m or 98ft; its range at an aperture of f/5.6 is $30 \div 5.6$ or about 5.3 meters (or in feet, $98 \div 5.6 = 17\text{ft. } 6\text{in.}$). For each twofold increase in ISO sensitivity, multiply the Guide Number by the square root of two (approximately 1.4).

The following features are available with CLS-compatible flash units:

Flash mode/feature		Speedlight			Advanced Wireless Lighting				
		SB-400	SB-800	SB-600	Commander		Remote		
					SB-800	SU-800 ¹	SB-800	SB-600	SB-R200
i-TTL ²		✓ ^{3,4}	✓ ³	✓ ³	✓ ⁵	✓ ⁵	✓ ⁵	✓ ⁵	✓ ⁵
AA	Auto aperture ²	—	✓ ⁶	—	✓ ⁷	✓ ⁸	✓ ⁸	—	—
A	Non-TTL auto	—	✓ ⁶	—	✓ ⁷	—	✓ ⁷	—	—
GN	Range-priority manual	—	✓	—	—	—	—	—	—
M	Manual	✓ ⁴	✓	✓	✓	✓	✓	✓	✓
RPT	Repeating flash	—	✓	—	✓	✓	✓	✓	—
REAR	Rear-curtain sync	✓	✓	✓	✓	✓	✓	✓	✓
	Red-eye reduction	✓	✓	✓	✓	—	—	—	—
Flash Color Information Communication		✓	✓	✓	✓	—	—	—	—
AF-assist for multi-area AF ²		✓	✓	✓	✓	✓	—	—	—
Auto zoom		—	✓	✓	✓	—	—	—	—
Auto ISO		✓	✓	✓	—	—	—	—	—

1. Only available when SU-800 is used to control other flash units.

2. CPU lens required.

3. Standard i-TTL for Digital SLR is used with spot metering or when selected with Speedlight. Otherwise i-TTL Balanced Fill-Flash for Digital SLR is used.

4. Can be selected from camera Custom Settings menu (878).

5. i-TTL Balanced Fill-Flash for Digital SLR

6. Use Speedlight controls to select flash mode. Non-TTL auto is selected automatically when a non-CPU lens is attached.

7. Auto aperture is selected automatically if CPU lens is attached. Non-TTL auto is selected automatically if non-CPU lens is attached.

8. Use Speedlight controls to select flash mode.

The following Speedlights can only be used in non-TTL auto and manual modes at shutter speeds of 1/500s or slower. Flash charge state is shown by the Speedlight flash-ready indicator. In TTL mode, the shutter-release button will lock and no photographs can be taken.

Flash mode		Speedlight	SB-80DX, SB-28DX, SB-28, SB-26, SB-25, SB-24	SB-50DX ¹ , SB-23, SB-29 ² SB-21B ² , SB-29s ²	SB-30, SB-27 ³ , SB-22S, SB-22, SB-20, SB-16B, SB-15
A	Non-TTL auto		✓	—	✓
M	Manual		✓	✓	✓
RPT	Repeating flash		✓	—	—
REAR	Rear-curtain sync ⁴		✓	✓	✓

1. In P, S, A, and M modes, lower built-in flash and use optional Speedlight only.

2. Autofocus is available only with AF-S VR ED 105 mm f/2.8G IF Micro Nikkor lenses.

3. When mounted on D40, flash mode is automatically set to TTL and shutter release is disabled. Set Speedlight to A (non-TTL auto) mode.

4. Available when camera is used to select flash mode.

Use Only Nikon Flash Accessories







Use only Nikon Speedlights. Negative voltages or voltages over 250V applied to the accessory shoe could not only prevent normal operation, but damage the sync circuitry of the camera or flash. Before using a Nikon Speedlight not listed in this section, contact a Nikon-authorized service representative for more information.







The AS-15 Accessory Shoe Adapter

When the AS-15 accessory shoe adapter (available separately) is mounted on the camera accessory shoe, flash accessories can be connected via a sync cable.

Notes on Optional Speedlights

Refer to the Speedlight manual for detailed instructions. If the Speedlight supports the Creative Lighting System, refer to the section on CLS-compatible digital SLR cameras. The D40 is not included in the “digital SLR” category in the SB-80DX, SB-28DX, and SB-50DX manuals.

If an optional Speedlight is attached with the camera in      or  mode, the built-in flash will turn off and the optional Speedlight will fire whenever a photograph is taken. The following flash modes are available:

- , , , , and  modes: Fill flash and red-eye reduction. Fill flash is automatically selected if the flash mode is set to off or auto when an optional Speedlight is attached. Auto with red-eye reduction becomes red-eye reduction.
-  mode: Auto slow sync becomes slow sync, auto slow sync with red-eye reduction becomes slow sync with red-eye reduction, and off becomes slow sync.

The optional Speedlight will not fire when the camera is in  mode.







If **AUTO** is selected for ISO sensitivity in      or  modes or **On** is selected for Custom Setting 10 (**ISO auto**) in P, S, A, or M mode, ISO sensitivity will be adjusted for optimal flash output when an optional SB-400, SB-800, or SB-600 Speedlight is attached. This may result in foreground subjects being underexposed in photographs taken with the flash at slow shutter speeds, in daylight, or against a bright background. Choose a flash mode other than slow sync or choose a larger aperture.

The shutter will synchronize with an external flash at speeds of $1/500$ s or slower.

i-TTL flash control can be used at ISO sensitivities between 200 and 1600. Higher values may not produce the desired results at some ranges or apertures. If the flash-ready indicator blinks for about three seconds after a photograph is taken, the flash has fired at full power and the photograph may be underexposed.

The SB-400, SB-800, and SB-600 provide red-eye reduction. With other Speedlights, the camera AF assist illuminator is used for AF-assist illumination and red-eye reduction.

In the following modes, the maximum aperture (minimum f/-number) varies with ISO sensitivity:

Mode	Maximum aperture at ISO sensitivity of			
	200	400	800	1600
     	4	4.8	5.6	6.7
	8	9.5	11	13

For each one-step increase in sensitivity (e.g., from 200 to 400), aperture is stopped down by half an f/-stop. If the maximum aperture of the lens is smaller than given above, the maximum value for aperture will be the maximum aperture of the lens.

When an SC-series 17, 28, or 29 sync cable is used for off-camera flash photography, correct exposure may not be achieved in i-TTL mode. We recommend that you choose spot metering to select standard i-TTL flash control. Take a test shot and view the results in the monitor.

In i-TTL mode, use the flash panel or bounce adapter provided with the Speedlight. Do not use other panels such as diffusion panels, as this may produce incorrect exposure. Auto power zoom is available only with SB-800 and SB-600 Speedlights.



Other Accessories

- Viewfinder eyepiece accessories**
- **Diopter adjustment viewfinder lenses:** Lenses are available with diopters of -5 , -4 , -3 , -2 , 0 , $+0.5$, $+1$, $+2$, and $+3\text{ m}^{-1}$. Use diopter adjustment lenses only if the desired focus can not be achieved with the built-in diopter adjustment control (-1.7 to $+0.5\text{ m}^{-1}$). Test diopter adjustment lenses before purchase to ensure that the desired focus can be achieved.
 - **DG-2 magnifier:** Magnify the scene displayed in the center of the viewfinder for close-up photography, copying, telephoto lenses, and other tasks that require added precision. Eyepiece adapter required (available separately).
 - **Eyepiece adapter:** Attach the DG-2 magnifier to the D40.
 - **DR-6 right-angle viewing attachment:** The DR-6 attaches at a right angle to the viewfinder eyepiece, allowing the image in the viewfinder to be viewed from above when the camera is in portrait orientation.
- Filters**
- Nikon filters can be divided into three types: screw-in, slip-in, and rear-interchange. Use Nikon filters; other filters may interfere with autofocus or electronic range finding.
 - The D40 can not be used with linear polarizing filters. Use the C-PL circular polarizing filter instead.
 - The NC and L37C filters are recommended for protecting the lens.
 - When using an R60 filter, set exposure compensation to $+1$.
 - Moiré may occur if a filter is used when the subject is framed against a bright light or when a bright light source is in the frame.
 - Center-weighted metering is recommended with filters with exposure factors (filter factors) over $1\times$ (Y48, O56, R60, X0, X1, C-PL, ND4S, ND8S, A2, A12, B2, B8, B12).

Approved Memory Cards

The following SD memory cards have been tested and approved for use in the D40. All cards of the designated make and capacity can be used, regardless of speed.

SanDisk	64MB, 128MB, 256MB, 512MB, 1GB, 2GB*, 4GB**†
Toshiba	64MB, 128MB, 256MB, 512MB, 1GB, 2GB*
Panasonic	64MB, 128MB, 256MB, 512MB, 1GB, 2GB*, 4GB**†
Lexar	128MB, 256MB, 512MB, 1GB, 2GB*

* If card will be used with card reader or other device, check that device supports 2GB and 4GB cards. † SDHC compliant. If card will be used with card reader or other device, check that device supports SDHC.



Operation is not guaranteed with other makes of card. Contact the manufacturer for details on the above cards.

✓ Memory Cards

- Format memory cards in the camera before first use.
- Turn the power off before inserting or removing memory cards. Do not remove memory cards from the camera, turn the camera off, or remove or disconnect the power source during formatting or while data are being recorded, deleted, or copied to a computer. Failure to observe these precautions could result in loss of data or in damage to the camera or card.
- Do not touch the card terminals with your fingers or metal objects.
- Do not apply force to the card casing. Failure to observe this precaution could damage the card.
- Do not bend, drop, or subject to strong physical shocks.
- Do not expose to heat, water, high levels of humidity, or direct sunlight.



Accessories for the D40

At the time of writing, the following accessories were available for the D40. Up to date information is available at Nikon websites or from our latest product catalogs.

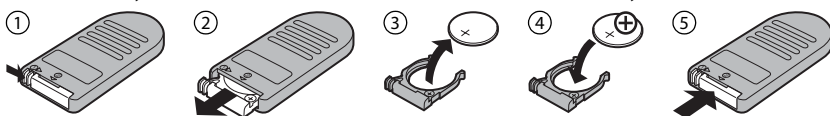
Power sources	<ul style="list-style-type: none">• EN-EL9 rechargeable Li-ion battery: Additional EN-EL9 batteries are available from local retailers and Nikon service representatives.• EH-5 AC adapter: Use to power the camera for extended periods. EP-5 AC adapter connector required (available separately).• EP-5 AC adapter connector: Connect the EH-5 to the D40.
Body caps	<ul style="list-style-type: none">• BF-1A body cap: The BF-1A keeps the mirror, viewfinder screen, and low-pass filter free of dust when a lens is not in place.
Video cables	<ul style="list-style-type: none">• EG-D100 video cable: View photos on TV or record them to video tape (862).
Remote controls	<ul style="list-style-type: none">• ML-L3 wireless remote control: Use as a remote shutter release for self-portraits or to prevent blur caused by camera shake. The ML-L3 uses a 3V CR2505 battery.
Software	<ul style="list-style-type: none">• Capture NX: A complete photo editing package with support for RAW images. Update to the most recent version.• Camera Control Pro: Control the camera remotely from a computer and save photographs directly to the computer. Update to the most recent version.

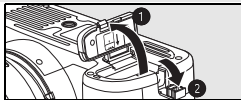
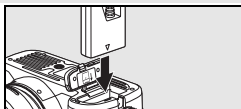
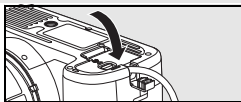
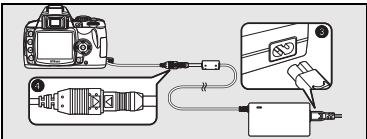

Connecting the Optional EP-5 AC Adapter Connector and EH-5 AC Adapter

- 1 Open the battery-chamber (①) and power-connector (②) covers.
- 2 Insert the EP-5 into the battery chamber as shown at right, making sure the "+" and "-" terminals are in the correct orientation.
- 3 Guide the power cord into the opening left by the power connector cover and close the battery-chamber cover.
- 4 Insert the EH-5 AC adapter plug into the EH-5 AC inlet (③) and connect the EH-5 DC plug to the EP-5 DC in connector (④). When the camera is powered by the AC adapter, the battery-level indicator in the monitor will show 

See the EP-5 and EH-5 instruction manuals for more information on using an AC adapter.

Caring for the Camera

Storage

When the camera will not be used for an extended period, turn the camera off, remove the battery, and store the battery in a cool, dry area with the terminal cover in place. To prevent mold or mildew, store the camera in a dry, well-ventilated area. Do not store the camera with naphtha or camphor moth balls or in locations that:

- are poorly ventilated or subject to humidities of over 60%
- are next to equipment that produces strong electromagnetic fields, such as televisions or radios
- are exposed to temperatures above 50°C/122°F (for example, near a space heater or in a closed vehicle in a hot day) or below -10°C (14°F)

Cleaning

Camera body	Use a blower to remove dust and lint, then wipe gently with a soft, dry cloth. After using the camera at the beach or seaside, wipe off sand or salt with a cloth lightly dampened in distilled water and dry thoroughly. Important: <i>Dust or other foreign matter inside the camera may cause damage not covered under warranty.</i>
Lens, mirror, and viewfinder	These elements are made of glass and are easily damaged. Remove dust and lint with a blower. If using an aerosol blower, keep the can vertical to prevent the discharge of liquid. To remove fingerprints and other stains, apply a small amount of lens cleaner to a soft cloth and clean with care.
Monitor	Remove dust and lint with a blower. When removing fingerprints and other stains, wipe the surface lightly with a soft cloth or chamois leather. Do not apply pressure, as this could result in damage or malfunction.

✓ The Monitor



Should the monitor break, care should be taken to avoid injury caused by broken glass and to prevent liquid crystal from the monitor from entering your eyes or mouth.

✓ Servicing the Camera and Accessories

The D40 is a precision device and requires regular servicing. Nikon recommends that the camera be inspected by the original retailer or Nikon service representative once every one to two years, and that it be serviced once every three to five years (note that fees apply to these services). Frequent inspection and servicing are particularly recommended if the camera is used professionally. Any accessories regularly used with the camera, such as lenses or optional Speedlights, should be included when the camera is inspected or serviced.

The Low-Pass Filter

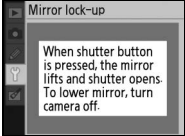
The image sensor that acts as the camera's picture element is fitted with a low-pass filter to prevent moiré. If you suspect that dirt or dust on the filter is appearing in photographs, you can clean the filter as described below. Note, however, that the filter is extremely delicate and easily damaged. Nikon recommends that the filter be cleaned only by Nikon-authorized service personnel. To prevent the camera from powering off while the mirror is raised, use a full-charged battery or an optional EH-5 AC adapter and EP-5 AC adapter connector (S 103).

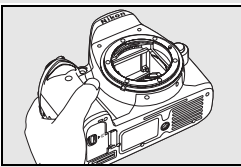
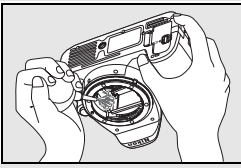
- 1 Remove the lens and turn the camera on.
- 2 Select **Mirror lock-up** from the setup menu (note that this option is not available at battery levels of  or below).
- 3 Highlight **On** and press **OK**. The message shown at right will be displayed. To restore normal operation without inspecting the low-pass filter, turn the camera off.
- 4 Press the shutter-release button all the way down. The mirror will be raised and the shutter curtain will open, revealing the low-pass filter.
- 5 Holding the camera so that light falls on the low-pass filter, examine the filter for dust or lint. If no foreign objects are present, proceed to Step 7.
- 6 Remove any dust and lint from the filter with a blower. Do not use a blower-brush, as the bristles could damage the filter. Dirt that can not be removed with a blower can only be removed by Nikon-authorized service personnel. Under no circumstances should you touch or wipe the filter.
- 7 Turn the camera off. The mirror will be lowered and the shutter curtain will close. Replace the lens or body cap.

Use a Reliable Power Source

The shutter curtain is delicate and easily damaged. If the camera turns off with the mirror raised, the curtain will close automatically. To prevent damage to the curtain, observe the following precautions:

- Do not turn the camera off until cleaning or inspection is complete. Do not remove or disconnect the power source while the mirror is raised.
- If the battery runs low while the mirror is raised, a beep will sound and the AF-assist illuminator will blink to warn that the shutter curtain will close and the mirror will be lowered after about two minutes. End cleaning or inspection immediately.

Caring for the Camera and Battery: Cautions

Do not drop: The product may malfunction if subjected to strong shocks or vibration.

Keep dry: This product is not waterproof, and may malfunction if immersed in water or exposed to high levels of humidity. Rusting of the internal mechanism can cause irreparable damage.

Avoid sudden changes in temperature: Sudden changes in temperature, such as occur when entering or leaving a heated building on a cold day, can cause condensation inside the device. To prevent condensation, place the device in a carrying case or plastic bag before exposing it to sudden changes in temperature.

Keep away from strong magnetic fields: Do not use or store this device in the vicinity of equipment that generates strong electromagnetic radiation or magnetic fields. Strong static charges or the magnetic fields produced by equipment such as radio transmitters could interfere with the monitor, damage data stored on the memory card, or affect the product's internal circuitry.

Do not leave the lens pointed at the sun: Do not leave the lens pointed at the sun or other strong light source for an extended period. Intense light may cause the image sensor to deteriorate or produce a white blur effect in photographs.

Blooming: Vertical white streaks may appear in photographs of the sun or other strong light sources. This phenomenon, known as "blooming," can be prevented by reducing the amount of light that falls on the image sensor, either by choosing a slow shutter speed and small aperture or by using an ND filter.

Do not touch the shutter curtain: The shutter curtain is extremely thin and easily damaged. Under no circumstances should you exert pressure on the curtain, poke it with cleaning tools, or subject it to powerful air currents from a blower. These actions could scratch, deform, or tear the curtain.

Handle all moving parts with care: Do not apply force to the battery-chamber, card-slot, or connector covers. These parts are especially susceptible to damage.

Lens contacts: Keep the lens contacts clean.

Turn the product off before removing or disconnecting the power source: Do not unplug the product or remove the battery while the product is on or while images are being recorded or deleted. Forcibly cutting power in these circumstances could result in loss of data or in damage to product memory or internal circuitry. To prevent an accidental interruption of power, avoid carrying the product from one location to another while the AC adapter is connected.

Cleaning: When cleaning the camera body, use a blower to gently remove dust and lint, then wipe gently with a soft, dry cloth. After using the camera at the beach or seaside, wipe off any sand or salt using a cloth lightly dampened in pure water and then dry the camera thoroughly.

The lens and mirror are easily damaged. Dust and lint should be gently removed with a blower. When using an aerosol blower, keep the can vertical to prevent discharge of liquid. To remove fingerprints and other stains from the lens, apply a small amount of lens cleaner to a soft cloth and wipe the lens carefully.

See "The Low-Pass Filter" (📖 105) for information on cleaning the low-pass filter.

Storage: To prevent mold or mildew, store the camera in a dry, well-ventilated area. If the product will not be used for an extended period, remove the battery to prevent leakage and store the camera in a plastic bag containing a desiccant. Do not, however, store the camera case in a plastic bag, as this may cause the material to deteriorate. Note that desiccant gradually loses its capacity to absorb moisture and should be replaced at regular intervals.

To prevent mold or mildew, take the camera out of storage at least once a month. Turn the camera on and release the shutter a few times before putting it away.

Store the battery in a cool, dry place. Replace the terminal cover before putting the battery away.

Notes on the monitor: The monitor may contain a few pixels that are always lit or that do not light. This is common to all TFT LCD monitors and does not indicate a malfunction. Images recorded with the product are unaffected.

Images in the monitor may be difficult to see in a bright light.

Do not apply pressure to the monitor, as this could cause damage or malfunction. Dust or lint on the monitor can be removed with a blower. Stains can be removed by wiping lightly with a soft cloth or chamois leather. Should the monitor break, care should be taken to avoid injury from broken glass and to prevent liquid crystal from the monitor touching the skin or entering the eyes and mouth.

Batteries: Dirt on the battery terminals can prevent the camera from functioning and should be removed with a soft, dry cloth before use. After removing the battery from the camera, be sure to replace the terminal cover.

Charge the battery before use. When taking photographs on important occasions, ready a spare EN-EL9 battery and keep it fully charged. Depending on your location, it may be difficult to purchase replacement batteries on short notice.

On cold days, the capacity of batteries tends to decrease. Be sure the battery is fully charged before taking photographs outside in cold weather. Keep a spare battery in a warm place and exchange the two as necessary. Once warmed, a cold battery may recover some of its charge.

Continuing to charge the battery after it is fully charged can impair battery performance.

Batteries may leak or explode if improperly handled. Observe the following precautions when handling batteries:

- Turn the product off before replacing the battery.
- The battery may become hot when used for extended periods. Observe due caution when handling the battery.
- Use only batteries approved for use in this equipment.
- Do not expose the battery to flame or excessive heat.

Used batteries are a valuable resource. Please recycle used batteries in accord with local regulations.

Foreign Matter on the Low-Pass Filter

Nikon takes every possible precaution to prevent foreign matter from coming into contact with the low-pass filter during production and shipping. The D40, however, is designed to be used with interchangeable lenses, and foreign matter may enter the camera when lenses are removed or exchanged. Once inside the camera, this foreign matter may adhere to the low-pass filter, where it may appear in photographs taken under certain conditions. To protect the camera when no lens is in place, be sure to replace the body cap provided with the camera, being careful to first remove all dust and other foreign matter that may be adhering to the body cap.

Should foreign matter find its way onto the low-pass filter, clean the filter or have it cleaned by authorized Nikon service personnel (📷 x). Photographs affected by the presence of foreign matter on the filter can be retouched using Capture NX (available separately; 📷 103) or the clean image options available in some third-party imaging applications.



Troubleshooting

If the camera fails to function as expected, check the list of common problems below before consulting your retailer or Nikon representative. Refer to the page numbers in the right-most column for more information.

Problem	Solution	
Camera takes time to turn on.	Delete files or folders.	20, 65
Viewfinder is out of focus.	Adjust viewfinder focus or use optional diopter adjustment lenses.	14, 102
Displays turn off without warning.	Choose a longer auto off delay.	78
Camera stops functioning	See "A Note on Electronically-Controlled Cameras," below.	—
Display in viewfinder is unresponsive and dim.	The response times and brightness of the viewfinder display varies with temperature.	—
Menu item is not displayed.	Select Full for CSM/Setup menu .	80
Menu item can not be selected.	Rotate mode dial to another setting or insert memory card.	4, 12
Image size can not be changed.	Image quality set to RAW or RAW+B .	30
Metering can not be changed.	Autoexposure lock in effect.	46
Can not measure white balance.	Subject is too dark or too bright.	71
Image can not be selected as source for preset white balance.	Image was not created with D40.	72
Full range of shutter speeds not available.	Flash in use.	117
Can not select focus area.	• Closest subject selected for AF-area mode: choose another mode.	24
	• Press shutter-release button halfway to activate exposure meters.	14
Focus does not lock when shutter-release button is pressed halfway.	Use AE-L/AF-L button to lock focus in AF-C autofocus mode or when photographing moving subjects in AF-A mode.	23, 26

A Note on Electronically-Controlled Cameras

In extremely rare instances, a strong external static charge may cause the camera may stop functioning. Turn the camera off, remove and replace the battery (note that the battery may be hot) or disconnect and reconnect the AC adapter, and turn the camera on again. If the problem persists, turn the camera off and press the reset switch (see right; note that this resets the clock). In the event of continued malfunction, contact your retailer or a Nikon-authorized service representative.

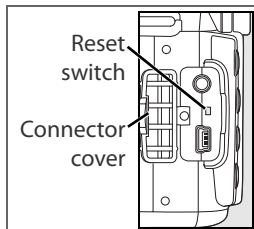

Problem	Solution	
Image in viewfinder is not in focus.	<ul style="list-style-type: none"> Manual focus selected: if AF-S or AF-I lens is attached, choose autofocus mode. Otherwise focus manually. Camera unable to focus using autofocus: use manual focus or focus lock. Lens is not AF-S or AF-I: use manual focus. 	28, 97 26, 28 28, 97
AF-assist illuminator does not light.	<ul style="list-style-type: none"> Mode dial rotated to  or : select another mode. AF-assist lamp does not light for manual focus or continuous-servo autofocus. Choose AF-S. Choose On for Custom Setting 9 (AF-assist). Illuminator has turned off automatically. Illuminator may become hot with continued use; wait for lamp to cool down. 	4, 18–19 23 76 —
Shutter release is disabled.	<ul style="list-style-type: none"> Memory card is full, locked, or not inserted. Flash is charging. Camera is not in focus. CPU lens with aperture ring attached without locking aperture at highest f/-number. Non-CPU lens is attached: rotate camera mode dial to M. Mode dial rotated to S after shutter speed of bulb selected in mode M: choose new shutter speed. 	12, 13, 15 17 23 8, 39 39, 43, 45 41, 43
No photo taken when remote control shutter-release button is pressed.	<ul style="list-style-type: none"> Replace battery in remote control. Choose remote control mode. Flash is charging. Time selected for Custom Setting 17 (Remote on duration) has passed: reselect remote control mode. Bright light is interfering with remote. 	103 33 17 79 —
Only one shot taken each time shutter-release button is pressed in continuous shooting mode.	Continuous shooting is not available when flash is raised.	32, 34, 36
Camera is slow to record photos.	Turn noise reduction off.	73
Date of recording is not correct.	Set camera clock.	11
Final photo is larger than area shown in viewfinder.	Viewfinder horizontal and vertical frame coverage is approximately 95%.	—
Randomly-spaced bright pixels (“noise”) appears in photographs.	<ul style="list-style-type: none"> Lower ISO sensitivity or use noise reduction. Shutter speed is slower than 1 s: use noise reduction. 	37, 73 73
Reddish areas appear in photos.	Reddish areas may appear in long time-exposures. Turn noise reduction on when shooting at shutter speeds of “bulb” or “--”.	44, 73
Colors are unnatural	<ul style="list-style-type: none"> Select mode P, S, A, or M and adjust white balance to match light source. Select mode P, S, A, or M and adjust Optimize image 	39, 49 39, 68 settings.















Problem	Solution	
Flashing areas appear in images	Press multi selector up or down to choose photo information displayed.	51
Shooting data appear on images		
A graph appears during playback		
RAW image is not played back.	Photo was taken at image quality of NEF + JPEG.	30
<ul style="list-style-type: none"> • Some photos are not displayed during playback • Message displayed stating that no images are available for playback. 	Select All for Playback folder . Note that Current will automatically be selected when next photo is taken.	66
"Tall" (portrait) orientation photos are displayed in "wide" (landscape) orientation.	• Select On for Rotate tall .	66
	• Photo was taken with Off selected for Auto image rotation .	88
	• Camera orientation was changed while shutter-release button was pressed in continuous shooting mode.	88
	• Camera was pointed up or down when photo was taken.	88
Can not delete photo.	Photo is protected: remove protection.	54
Can not change print order.	Memory card is full or locked.	13, 15
Can not select photo for printing.	Photo is in RAW (NEF) format. Transfer to computer and print using PictureProject or Capture NX.	55, 57
Can not print pictures via direct USB connection.	Set USB to PTP .	58, 84
Photo is not displayed on TV.	Choose correct video mode.	62, 83
Can not copy photos to computer.	Choose correct USB option.	55
Can not use Camera Control Pro.	Set USB to PTP .	55, 56





Camera Error Messages and Displays

This section lists common warning indicators and error messages that appear in the viewfinder and monitor.

Message	Viewfinder	Solution	
Lock lens aperture ring at minimum aperture (largest f/-number).	FE E (blinks)	Lock ring at minimum aperture (largest f/-number).	8, 39
Lens not attached.	F- -/? (blinks)	<ul style="list-style-type: none"> No lens attached: attach lens. Attached lens is not CPU lens: select mode M. 	8 39, 43, 45
Attach a lens.	F- -/4 (blinks)		
Initialization error. Turn camera off and then on again.	 (blinks)	Turn camera off, remove and reinsert battery, and then turn camera on again.	—
This battery cannot be used. Choose battery designated for use in this camera.	 (blinks)	Insert EN-EL9 battery.	7, 9– 10
Battery level is low. Complete operation and turn camera off immediately.	 (blinks)	End cleaning or inspection of low-pass filter and turn camera off immediately.	105
Shutter release disabled. Recharge battery.	 (blinks)	Turn camera off and recharge battery or replace with fully-charged spare battery.	9–10, 15
Clock not set.	? (blinks)	Set camera clock.	11
NO MEMORY CARD.	(-E-)	Insert memory card.	12–13
Memory card is locked. Slide lock to “write” position.	[CHR] (blinks)	Slide card write-protect switch to “write” position.	13
This card can not be used.	[CHR] (blinks)	<ul style="list-style-type: none"> Use Nikon-approved card. Card may be damaged. Contact retailer or Nikon-authorized service representative. Delete unwanted files or insert new memory card. 	102 x 12–13, 20, 65
This card is not formatted. Format the card.	(For) (blinks)	Format memory card.	13, 81
Card is full.	FuL (blinks)	<ul style="list-style-type: none"> Reduce image quality or size. Delete photographs. Insert new memory card. 	29–30 20, 65 12
Subject is too bright.	Hi	<ul style="list-style-type: none"> Choose lower ISO sensitivity. Increase shutter speed. Choose smaller aperture (larger f/-number). Use optional Neutral Density (ND) filter. 	37 39–44 39–44 102
Subject is too dark.	Lo	<ul style="list-style-type: none"> Choose higher ISO sensitivity. Decrease shutter speed. Choose larger aperture (smaller f/-number). 	37 39–44 39–44

Message	Viewfinder	Solution	
—	 (blinks)	Flash has fired at full power. View photo; if underexposed, adjust settings and try again.	20, 45, 48, 50, 76, 78
—	 (blinks)	<ul style="list-style-type: none"> Built-in flash is lowered: raise built-in flash. Flash head on optional SB-400 Speedlight is in bounce-flash position. SB-400 is unable to fully illuminate subject at current lens focal length. Increase distance to subject (this warning is not displayed with other optional Speedlights). 	34, 99, 99
Flash is in TTL mode. Choose another setting or use a CPU lens.	 (blinks)	Change flash control mode for optional Speedlight.	100
No Bulb in S mode.	 (blinks)  (blinks)	Change shutter speed or select mode M.	39–44
Unable to measure white balance. Please try again.	 (blinks)	Camera unable to measure preset white balance. Adjust exposure settings and try again.	47, 70
Folder contains no images.	—	<ul style="list-style-type: none"> Insert another memory card. Set Playback folder to All. 	12, 66
File does not contain image data.	—	Delete file or reformat memory card.	13, 20, 65
Check printer.	—	Insert new ink or toner cartridge in printer. If error occurs with ink remaining in printer, check printer status.	60
Error. Press shutter release button again.	 (blinks)	Press shutter-release button again. If error persists, consult with Nikon-authorized service representative.	x, 16–17
Initialization error. Contact Nikon-authorized service representative.	 (blinks)	Contact Nikon-authorized service representative.	x

Help

A blinking  is displayed in the monitor or viewfinder indicates that a description of the current problem can be viewed by pressing the  button.

Appendix

The Appendix covers the following topics:

- **Available Settings and Defaults** 113
- **The Command Dial** 115
- **Memory Card Capacity and Image Quality/Size** 116
- **Exposure Program (Mode P)** 116
- **Flash Control** 117
- **Shutter Speeds Available with the Built-in Flash** 117
- **Aperture, Sensitivity, and Flash Range** 117
- **Supported Standards** 117
- **White Balance and Color Temperature** 118

Available Settings and Defaults

The following table lists the settings that can be adjusted in each mode.

	AUTO								P	S	A	M
Shooting menu	Optimize image								✓	✓	✓	✓
	Image quality ¹	✓	✓	✓	✓	✓	✓	✓	✓	✓	✓	✓
	Image size ¹	✓	✓	✓	✓	✓	✓	✓	✓	✓	✓	✓
	White balance ¹								✓	✓	✓	✓
	ISO sensitivity ¹	✓	✓	✓	✓	✓	✓	✓	✓	✓	✓	✓
	Noise reduction	✓	✓	✓	✓	✓	✓	✓	✓	✓	✓	✓
Custom Settings²	1: Beep	✓	✓	✓	✓	✓	✓	✓	✓	✓	✓	✓
	2: Focus mode ¹	✓	✓	✓	✓	✓	✓	✓	✓	✓	✓	✓
	3: AF-area mode ¹	✓ ³	✓ ³	✓ ³	✓ ³	✓ ³	✓ ³	✓ ³	✓ ³	✓	✓	✓
	4: Shooting mode ¹	✓	✓	✓	✓	✓	✓	✓	✓	✓	✓	✓
	5: Metering ¹								✓	✓	✓	✓
	6: No memory card?	✓	✓	✓	✓	✓	✓	✓	✓	✓	✓	✓
	7: Image review	✓	✓	✓	✓	✓	✓	✓	✓	✓	✓	✓
	8: Flash level								✓	✓	✓	✓
	9: AF-assist	✓	✓	✓		✓		✓	✓	✓	✓	✓
	10: ISO auto								✓	✓	✓	✓
	11: /Fn button	✓	✓	✓	✓	✓	✓	✓	✓	✓	✓	✓
	12: AE-L/AF-L	✓	✓	✓	✓	✓	✓	✓	✓	✓	✓	✓
	13: AE lock	✓	✓	✓	✓	✓	✓	✓	✓	✓	✓	✓
	14: Built-in flash								✓	✓	✓	✓
	15: Auto off timers	✓	✓	✓	✓	✓	✓	✓	✓	✓	✓	✓
	16: Self-timer	✓	✓	✓	✓	✓	✓	✓	✓	✓	✓	✓
	17: Remote on duration	✓	✓	✓	✓	✓	✓	✓	✓	✓	✓	✓
Other settings	Flash mode ¹	✓ ³		✓ ³	✓ ⁴	✓ ³	✓ ⁴	✓ ³	✓ ³	✓	✓	✓
	Autoexposure lock ¹	✓	✓	✓	✓	✓	✓	✓		✓	✓	✓
	Exposure compensation ¹								✓	✓	✓	✓
	Flexible program ¹								✓			

1. Reset with two-button reset (38).

2. Reset with Custom Setting R (**Reset**).

3. Reset with when mode dial is rotated to new setting.

4. Available with optional Speedlight only.



The following defaults are restored with Custom Setting R (**Reset**):

	AUTO								P	S	A	M
1: Beep	On											
2: Focus mode	AF-A											
3: AF-area mode	Closest subject				Dynamic Single		Closest subject					
4: Shooting mode	Single frame											
5: Metering	Matrix											
6: No memory card?	Release locked											
7: Image review	On											
8: Flash level	—										0.0	
9: AF-assist	On	—	On	—	On							
10: ISO auto	—											Off ¹
11: Fn button	Self-timer											
12: AE-L/AF-L	AE/AF lock											
13: AE lock	Off											
14: Built-in flash	—										TTL	
15: Auto off timers	Normal											
16: Self-timer	10s											
17: Remote on duration	1 min.											

1. **Max. sensitivity** set to **800**, **Min. shutter speed** set to **1/30**.





















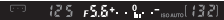









Defaults for other settings are listed below.

	AUTO								P	S	A	M	
Playback	Playback folder												
	Slide show: Frame interval												
	Rotate tall												
Shooting menu	Optimize image										Normal		
	Image quality												
	Image size												
	White balance												
	ISO sensitivity										200		
	Noise reduction												
Setup menu	CSM/Setup menu												
	Display format												
	Auto shooting info												
	World time												
	LCD brightness												
	Video mode												
	Language												
	Image comment												
	USB												
	Folders												
Other settings	Focus area												
	Focus lock												
	Flexible program										Off	—	
	AE lock hold												
	Exposure compensation										0.0		
	Flash mode		Auto	—	Auto	—	Auto	—	Auto	Slow*	Fill flash		

* Auto slow sync.

The Command Dial

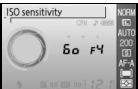
The command dial can be used in alone or in combination with other controls to adjust the following settings. Changes to the affected setting are visible in the viewfinder and shooting information display.

Exposure		
	Choose a combination of aperture and shutter speed (flexible program, mode P;  40).	
	Choose a shutter speed (modes S and M;  41, 43).	
	Set aperture (mode A;  42).	
	Set aperture (mode M;  43).	
 + 	Set exposure compensation (modes P, S, and A  47).	
		
		
Flash settings		
 + 	Choose a flash mode ( , P, S, A, and M modes;  34–36).	
 + 	Set flash compensation (P, S, A, and M modes;  48).	
		
Fn button (available when the following options are selected for Custom Setting 11;  77)		
	Shooting mode	
 + 	Image quality/size	
	ISO sensitivity	
	White balance	

Memory Card Capacity and Image Quality / Size

The following table shows the approximate number of pictures that can be stored on a 512MB Panasonic Pro HIGH SPEED memory card at different image quality and size settings.

Image quality	Image size	File size (MB) ¹	Number of images ¹	Buffer capacity ^{1,2}
RAW	—	5.0MB	65	5
FINE	L	2.9MB	137	100
	M	1.6MB	235	100
	S	0.8MB	503	100
NORMAL	L	1.5MB	260	100
	M	0.8MB	444	100
	S	0.4MB	839	100
BASIC	L	0.8MB	503	100
	M	0.4MB	755	100
	S	0.2MB	1.2k	100
RAW+BASIC	—/L	5.8MB ³	58	4

1. All figures are approximate and assume average file size; actual file size and memory card capacity may vary with scene recorded and make of memory card.

2. Maximum number of frames that can be taken before shooting stops. Actual number of photos that can be taken before buffer fills may vary with make of memory card. Additional photographs can be taken as soon as enough memory is available in buffer.

3. Total file size of NEF (RAW) and JPEG images.

Exposure Program (Mode P)

The exposure program for mode P is shown in the following graph.

- F (lens focal length) ≤ 55 mm
- 135 mm ≥ F > 55 mm
- F > 135 mm

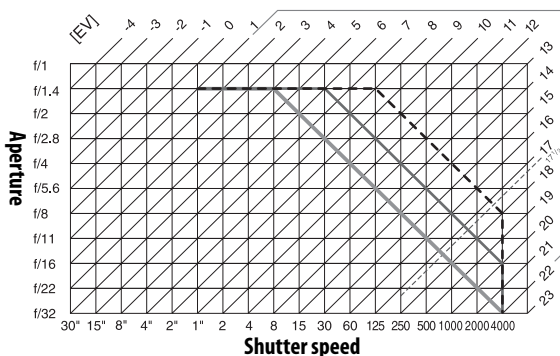

The maximum and minimum values for EV vary with ISO sensitivity; the above graph assumes an ISO sensitivity of ISO 200 equivalent. When matrix metering is used, values over 17¹/₃EV are reduced to 17¹/₃EV.

Flash Control 99–101





The following types of flash control are supported when a CPU lens is used in combination with the built-in flash or optional SB-400, SB-800, or SB-600 Speedlights.

- **i-TTL Balanced Fill-Flash for Digital SLR:** Flash output is adjusted for a natural balance between the main subject and the background.
- **Standard i-TTL Fill-Flash for Digital SLR:** Flash output is adjusted for the main subject; the brightness of the background is not taken into account. Recommended for use with exposure compensation, for shots in which the main subject is emphasized at the expense of background details, or when using an SC-series 17, 28, or 29 sync cable.

Standard i-TTL flash control is used with spot metering or when selected with the optional Speedlight. i-TTL balanced fill-flash for digital SLR is used in all other cases.

Shutter Speeds Available with the Built-in Flash

The following shutter speeds are available when the built-in flash is used.

Mode	Shutter speed	Mode	Shutter speed
AUTO,  ,  , P, A	1/500–1/60 S		1/500–1 s
	1/500–1/125 S	S, M	1/500–30 s

Aperture, Sensitivity, and Flash Range

Flash range varies with sensitivity (ISO equivalency) and aperture.

Aperture at ISO equivalent of				Range	
200	400	800	1600	m	ft.
2	2.8	4	5.6	1.0–7.5	3ft. 3in.–24ft. 7in.
2.8	4	5.6	8	0.7–5.4	2ft. 4in.–17ft. 9in.
4	5.6	8	11	0.6–3.8	2ft.–12ft. 6in.
5.6	8	11	16	0.6–2.7	2ft.–8ft. 10in.
8	11	16	22	0.6–1.9	2ft.–6ft. 3in.
11	16	22	32	0.6–1.4	2ft.–4ft. 7in.
16	22	32	—	0.6–0.9	2ft.–2ft. 11in.
22	32	—	—	0.6–0.7	2ft.–2ft. 4in.







Supported Standards

- **DCF Version 2.0:** The Design Rule for Camera File Systems (DCF) is a standard widely used in the digital camera industry to ensure compatibility among different makes of camera.
- **DPOF:** Digital Print Order Format (DPOF) is an industry-wide standard that allows pictures to be printed from print orders stored on the memory card.
- **Exif version 2.21:** The D40 supports Exif (**Exchangeable Image File Format** for Digital Still Cameras) version 2.21, a standard in which information stored with photographs is used for optimal color reproduction when the images are output on Exif-compliant printers.
- **PictBridge:** A standard developed through cooperation with the digital camera and printer industries, allowing photographs to be output directly to a printer without first transferring them to a computer.



White Balance and Color Temperature

Approximate color temperatures for each white balance setting are given below (values may differ from color temperatures given by photo color meters):

White balance	Fine tuning							
	None	-3	-2	-1	+1	+2	+3	
AUTO Auto	3,500K–8,000K	Fine tuning added to value selected by camera						
 Incandescent	3,000K	3,300K	3,200K	3,100K	2,900K	2,800K	2,700K	
 Fluorescent*	4,200K	7,200K	6,500K	5,000K	3,700K	3,000K	2,700K	
 Dir. sunlight	5,200K	5,600K	5,400K	5,300K	5,000K	4,900K	4,800K	
 Flash	5,400K	6,000K	5,800K	5,600K	5,200K	5,000K	4,800K	
 Cloudy	6,000K	6,600K	6,400K	6,200K	5,800K	5,600K	5,400K	
 Shade	8,000K	9,200K	8,800K	8,400K	7,500K	7,100K	6,700K	
PRE White balance preset	—	Not available						

* Color temperature range reflects wide variation among fluorescent light sources, ranging from low-temperature stadium lighting to high-temperature mercury-vapor lamps.

Specifications

Type	Single-lens reflex digital camera with interchangeable lenses		
Effective pixels	6.1 million		
CCD	23.7×15.6mm; total pixels: 6.24 million		
Image size (pixels)	• 3,008×2,000 (Large)	• 2,256×1,496 (Medium)	• 1,504×1,000 (Small)
Lens mount	Nikon F mount with AF coupling and AF contacts		
Compatible lenses*			
Type G or D AF Nikkor			
AF-S, AF-I	All functions supported		
Other Type G or D Nikkor	All functions supported except autofocus		
Micro Nikkor 85 mm f/2.8D	Can only be used in mode M ; all other functions supported except autofocus		
Other AF Nikkor†/AI-P Nikkor	All functions supported except autofocus and 3D color matrix metering II		
Non-CPU	Can be used in mode M , but exposure meter does not function; electronic range finder can be used if maximum aperture is f/5.6 or faster.		

*IX Nikkor lenses can not be used

†Excluding lenses for F3AF

Picture angle	Equivalent in 35-mm format is approximately 1.5 times lens focal length.		
Viewfinder	Fixed eye-level penta-Dach mirror type		
Diopter	-1.7 – +0.5 m ⁻¹		
Eyepoint	18mm (-1.0m ⁻¹)		
Focusing screen	Type B BriteView clear matte screen Mark V with superimposed focus brackets		
Frame coverage	Approximately 95% of lens (vertical and horizontal)		
Magnification	Approximately 0.8× (50-mm lens at infinity; -1.0m ⁻¹)		
Reflex mirror	Quick return		
Lens aperture	Electronically controlled with instant return		
Self-timer	Electronically controlled timer with 2, 5, 10 or 20s duration		
Focus-area selection	Focus area can be selected from 3 focus areas		
Lens servo	<ul style="list-style-type: none"> • Autofocus (AF): Instant single-servo AF (AF-S); continuous-servo AF (AF-C); auto AF-S/AF-C selection (AF-A); predictive focus tracking activated automatically according to subject status • Manual focus (M) 		
Storage			
Media	SD (Secure Digital) memory cards; camera supports SDHC		
File system	Compliant with Design Rule for Camera File System (DCF) 2.0 and Digital Print Order Format (DPOF)		
Compression	• NEF (RAW) : compressed 12-bit • JPEG : JPEG baseline-complaint		
Autofocus	TTL phase detection by Nikon Multi-CAM 530 autofocus sensor module with AF-assist illuminator (range approximately 0.5–3.0m/1 ft. 8in.–9ft. 10in.)		
Detection range	-1.0 – +19EV (ISO 100 at 20°C/68°F)		
AF-area mode	Single-area AF, dynamic-area AF, dynamic-area AF with closest subject priority		
Focus lock	Focus can be locked by pressing the shutter-release button halfway (single-servo AF) or by pressing the AE-L/AF-L button		
ISO sensitivity (Recommended Exposure Index)	200 – 1600 in steps of 1 EV with additional setting one step over 1600		



Exposure	
Metering	Three-mode through-the-lens (TTL) exposure metering
Matrix	3D color matrix metering II (type G and D lenses); color matrix metering II (other CPU lenses); metering performed by 420-segment RGB sensor
Center-weighted	Weight of 75% given to 8-mm circle in center of frame
Spot	Meters 3.5-mm circle (about 2.5% of frame) centered on active focus area
Range (ISO 100 equivalent, f/1.4 lens, 20°C/68°F)	0–20 EV (3D color matrix or center-weighted metering) 2–20 EV (spot metering)
Exposure meter coupling	CPU coupling
Digital Vari-Program/exposure modes	Digital Vari-Program (📷 auto, 📷 auto/no flash, 📷 portrait, 📷 landscape, 📷 child, 📷 sports, 📷 close-up, 📷 night portrait); programmed auto (P) with flexible program; shutter-priority auto (S); aperture-priority auto (A); manual (M)
Exposure compensation	–5 to +5 EV in increments of 1/3 EV
Exposure lock	Exposure locked at detected value with AE-L/AF-L button
Shutter	
Speed	Combined mechanical and CCD electronic shutter
	30–1/4,000 s in steps of 1/3 EV, bulb
White balance	
	Auto (TTL white balance with 420-segment RGB sensor); six manual modes with fine tuning and preset white balance
Built-in flash	
	• 📷, 📷, 📷, 📷, 📷: Auto flash with auto pop-up • P, S, A, M: Manual pop-up with button release
Guide number (m/ft)	• Approximately 17/55 at ISO 200 and 20°C/68°F (manual 18/59) • Approximately 12/39 at ISO 100 and 20°C/68°F (manual 13/42)
Flash	
Sync contact	X-contact only; flash synchronization at shutter speeds of up to 1/500 s
Flash control	
TTL	TTL flash control by 420-segment RGB sensor. i-TTL balanced fill-flash for digital SLR and standard i-TTL fill-flash for digital SLR available when CPU lens is used with built-in flash, SB-400, SB-800, and SB-600
Auto aperture	Available with SB-800 and CPU lens
Non-TTL auto	Available with such Speedlights as SB-800, 80DX, 28DX, 28, 27, and 22s
Range-priority manual	Available with SB-800
Flash mode	<ul style="list-style-type: none"> • 📷, 📷, 📷, 📷, 📷: Auto, auto with red-eye reduction; fill-flash and red-eye reduction available with optional Speedlight • 📷: Auto, auto slow sync, auto slow sync with red-eye reduction; slow sync and slow sync with red-eye reduction available with optional Speedlight • 📷, 📷: Fill-flash and red-eye reduction available with optional Speedlight • P, A: Fill flash, rear-curtain with slow sync, slow sync, slow sync with red-eye reduction, red-eye reduction • S, M: Fill flash, rear-curtain sync, red-eye reduction
Flash-ready indicator	Lights when built-in flash or SB-series Speedlight such as 400, 800, or 600 is fully charged; blinks for about 3 s after flash is fired at full output
Accessory shoe	Standard ISO hot-shoe contact with sync, signal, and ground contacts and safety lock
Nikon Creative Lighting System	Supported with built-in flash, SB-400, SB-800, and SB-600; Advanced Wireless Lighting supported with SB-800 or SU-800 as Commander.
Monitor	2.5 in., 230,000-dot, low-temperature polysilicon TFT LCD with brightness adjustment
Video output	Can be selected from NTSC and PAL
External interface	USB 2.0 Hi-speed
Tripod socket	1/4 in. (ISO 1222)
Firmware upgrades	Firmware can be upgraded by user

Supported languages	Chinese (Simplified and Traditional), Dutch, English, Finnish, French, German, Italian, Japanese, Korean, Polish, Portuguese, Russian, Spanish, Swedish
Power source	<ul style="list-style-type: none"> • One rechargeable Nikon EN-EL9 Li-ion battery; charging voltage (MH-23 quick charger): 7.4V DC • EH-5 AC adapter (available separately; requires optional EP-5 AC adapter connector)
Dimensions (W×D×H)	Approximately 126×64×94mm (5.0×2.5×3.7 in.)
Approximate weight	475g (1 lb. 1 oz.) without battery, memory card, or body cap
Operating environment	
Temperature	0–+40°C (+32–104°F)
Humidity	Less than 85% (no condensation)

Unless otherwise stated, all figures are for a camera with a fully-charged battery operating at an ambient temperature of 20°C (68°F).

EN-EL9 Rechargeable Li-ion Battery

Type	Rechargeable lithium-ion battery
Rated capacity	7.4V/1000mAh
Dimensions (W×D×H)	Approximately 36×56×14mm (1.4×2.2×0.6 in.)
Approximate weight	51g (1.8 oz.), excluding power cable

Battery Life

Battery life varies with charge state and shooting conditions. The number of shots that can be taken with a fully-charged EN-EL9 battery (1000mAh) is approximately 470 shots in single-frame shooting mode and 2,200 shots in continuous shooting mode. Battery life for single frame shooting mode is measured according to CIPA standards (lens cycled from infinity to minimum range and shutter released at default settings once every 30s; flash fired with every other shot). Battery life for continuous shooting mode is measured with image quality set to JPEG Basic, a shutter speed of 1/250s, the shutter release pressed halfway for three seconds and focus then cycled from infinity to minimum range three times; after six shots, the monitor is turned on for five seconds and then turned off; the cycle is repeated once exposure meters have turned off. All measurements are performed with an 18–55 mm f/3.5–5.6GII ED AF-S DX Zoom-Nikkor lens.

The following can reduce battery life:

- Using the monitor
- Keeping the shutter-release button pressed halfway
- Repeated autofocus operations
- Taking RAW (NEF) photographs
- Slow shutter speeds
- Using vibration reduction with VR lenses

To ensure maximum battery performance:

- Keep the battery contacts clean. Soiled contacts can reduce battery performance.
- Use batteries immediately after charging. Batteries will lose their charge if left unused.

The battery level displayed by the camera may vary with changes in temperature.

Specifications

Nikon reserves the right to change the specifications of the hardware and software described in this manual at any time and without prior notice. Nikon will not be held liable for damages that may result from any mistakes that this manual may contain.

MH-23 Quick Charger

Rated input	AC 100–240V, 50/60Hz
Rated output	DC 8.4V/0.9A
Supported batteries	EN-EL9 rechargeable Li-ion batteries
Charging time	Approximately 90 minutes
Operating temperature	0–+40°C (+32–104°F)
Dimensions (W×D×H)	Approximately 82.5×65×28mm (3.2×2.6×1.1 in.)
Length of cord	Approximately 1.8m (5ft. 11 in.)
Approximate weight	80g (2.8 oz.), excluding power cable

18–55 mm f/3.5–5.6GII ED AF-S DX Zoom-Nikkor Lens (Available Separately)

Type	G-type AF-S DX Zoom-Nikkor lens with built-in CPU and Nikon mount
Supported cameras	Nikon DX-format digital cameras
Focal length	18–55mm
Max. reproduction ratio	1:3.5–5.6
Construction	7 elements in 5 groups (including 1 ED glass element and 1 aspherical element)
Angle	76°–28° 50'
Zoom positions	18, 24, 35, 45, 55
Distance information	Supplied to camera body
Zoom	Zoom adjusted by rotating lens ring
Focus	Autofocus with low-noise motor; manual focus
Min. focus distance	0.28m (11 in.) at all zoom positions
Aperture	Seven blade diaphragm with auto aperture
Aperture range	f/3.5–22 (18 mm zoom); f/5.6–38 (55 mm zoom)
Metering	Maximum aperture
Filter diameter	52mm (P=0.75 mm)
Dimensions (W×D×H)	Approximately 70.5mm diameter×74mm/2.8×3.0in. from standard bayonet mount surface to front of lens
Approximate weight	205 g (7.2 oz.)
Lens hood	HB-33 (available separately; attaches as shown below)

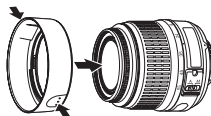

Index

Symbols

3D color matrix metering II.
See Metering
420-segment RGB sensor. See Metering; White balance
⊗ (aperture) button, 2, 43
⊕ (auto/flash off mode), 4, 18
⊖ (child mode), 4, 19
⬆ (close-up mode), 4, 19
📷 (continuous shooting indicator), 6, 32
🗑 (delete) button, 3, 20, 54
🔑/**Fn** button (Custom Settings menu), 77, 115
☑ (exposure compensation), 5, 6, 47
⊕ (exposure compensation) button, 2, 47
⚡ (flash compensation), 5, 6, 48
⚡ (flash compensation) button, 2, 48
⚡ (flash-ready indicator), 5, 17, 111–112
⚡ (flash mode) button, 2, 34
? (help) button, 3
? (help indicator), 3, 111–112
🌄 (landscape mode), 4, 18
👤 (night portrait mode), 4, 19
▶ (playback) button, 3, 20, 50
🔍 (playback zoom) button, 3, 50, 52, 53
👤 (portrait mode), 4, 18
🔒 (protect) button, 3, 54
📡 (remote control indicator), 32, 33
⌚ (self-timer) button, 2, 33
⌚ (self timer indicator), 32, 33
⚽ (sports mode), 4, 19
👉 (thumbnail) button, 3, 50, 52, 53

A

A. See Aperture-priority auto
Accessories. See also Battery;
Lens; Flash, optional
optional, 96–103
supplied, 7
Ⓜ/Ⓛ (AE-L/AF-L) button, 3, 46, 77
Adobe RGB. See Color mode
Advanced Wireless Lighting,
100
AE-L/AF-L (Custom Settings
menu), 77
AE lock (Custom Settings
menu), 77
AF-A. See Focus, mode
AF-area mode. See Focus, AF-
area mode

AF-area mode (Custom Set-
tings menu), 24, 75

AF-assist (Custom Settings
menu), 76
AF-assist illuminator, 2, 23, 76
AF-C. See Focus, mode
AF-S. See Focus, mode
AF-S/AF-I. See Lens, AF-S/AF-I
Aperture, 6, 39–44, 117
maximum, 28, 42, 43, 101
minimum, 8, 39, 42, 43
Aperture-priority auto, 39, 42
Autoexposure lock, 46, 77. See
also **AE lock**
Autofocus. See Focus
Auto image rotation (setup
menu), 88
Auto meter off, 14
Ⓜ (auto mode), 4, 15–17
Auto off timers (Custom Set-
tings menu), 78
Auto shooting info (setup
menu), 83

B

BASIC. See Image quality
Battery, 7, 9–10, 15, 103, 106–
107, 121. See also Clock, bat-
tery
EN-EL9, 7, 9–10, 103, 121
inserting, 9–10
life, 121
storage, 106–107
Beep (Custom Settings menu),
74
Black and white, 68, 92
Blur, reducing, 32, 41, 44. See
also Self timer; Shooting
mode, delayed remote;
Shooting mode, quick-
response remote
Brightness. See Exposure;
Flash, level; **LCD brightness**;
Monitor, brightness of
Built-in flash (Custom Set-
tings menu), 78
Bulb. See Long time-exposures
Burst. See Shooting mode,
continuous

C

Camera Control Pro, 56, 103
Capture NX, 31, 87, 103
Center-weighted. See Meter-
ing
Clock, 83, 111
battery, 83
Close up, 4, 19
Closest subject priority. See
Focus, AF-area mode

CLS. See Creative Lighting Sys-
tem

Color. See Color mode; **Filter
effects**; Hue; Saturation;
White balance
Color mode, 69
Color profile. See Color mode
Color space. See Color mode
Color temperature, 70, 118. See
also White balance
Computer, 55–56
Continuous. See Shooting
mode, continuous
Continuous-servo AF. See
Focus, autofocus, mode
Contrast, 68–69. See also **Opti-
mize image**; Tone compen-
sation
Copies. See **Small picture**
Creative Lighting System (CLS),
99–101
Crop, 59, 91. See also Printing;
Trim
CSM/Setup menu (setup
menu), 80–81
Custom Settings, 74–79

D

Date, 11, 83. See also Clock;
World time
Daylight saving time, 11, 83.
See also **World time**
DCF. See Design Rule for Cam-
era File System
Default settings, 38, 74, 113–
114. See also **Reset**; Two-but-
ton reset
Delete, 20, 54, 65. See also
Memory card, formatting; Pro-
tecting photographs
all images, 65
selected images, 65
single-frame playback, 20, 54
Delete (playback menu), 65
Depth of field, 39–40, 42
Design Rule for Camera File
System, 117
Digital Print Order Format, 57,
60–61, 117
Digital Vari-Program, 4, 18–19
Diopter, 14. See also Viewfinder
D-lighting, 90
D-lighting (retouch menu), 90
DPOF. See Digital Print Order
Format
Dust off ref photo (setup
menu), 87
Dynamic area AF. See Focus,
AF-area mode

E

Electronic range finder. See
Focus, manual
Exif version 2.21, 117
Exposure, 39–44, 45–48. See
also Aperture; Aperture-prior-
ity auto; Autoexposure lock;
Programmed auto; Shutter-
priority auto; Shutter speed;
Manual mode
compensation, 47
electronic analog exposure
display, 43
meters, 14, 78
program, 116
Eyepiece cap, 7, 33

F

File, 29–31, 51, 86, 116
format, 31, 117
File no. sequence (setup
menu), 86
Filter. See also Accessories,
optional; **Filter effects**
Neutral Density (ND), 102,
111
Filter effects (retouch menu),
92
Firmware. See **Firmware ver-
sion**
Firmware version (setup
menu), 86
FINE. See Image quality
Flash
built in, 2, 17, 34–36, 78
compensation, 48
level, 76
mode, 34–36
optional, 99–101
range, 17, 117
ready indicator, 5, 17, 111–
112
remote, 99
Flexible program. See Pro-
grammed auto
Fn (function) button, 2, 77
Focus, 23–28
AF-area mode, 24, 75
area, 24, 25
center, 19, 25
autofocus, 23–27
lock, 26–27
manual, 28
mode, 23, 75
tracking, 119
Folder, 51, 66, 85
playback, 66
recording, 85
Folders (setup menu), 85



Format memory card (setup menu), 13, 81

H

Help, 3, 112
Highlights, 52
Histogram, 52, 92
Hue, 69

I

 (setting) button, 3, 22
Illuminator. *See* AF-assist illuminator

Image comment (setup menu), 84

Image overlay (retouch menu), 94–95

Image quality, 29–31, 70
NEF (RAW), 30–31

Image quality (shooting menu), 30, 70

Image sensor, 30, 86, 105, 106
dimensions of, 119

Image size, 29–31, 70

Image review (Custom Settings menu), 75

Image size (shooting menu), 30, 70

 (shooting information) button, 2, 22

Info display format (setup menu), 81–82

ISO auto (Custom Settings menu), 76

ISO sensitivity, 37, 73, 76
auto, 37, 76

ISO sensitivity (shooting menu), 37, 73

i-TTL flash control, 78, 99–101

J

JPEG, 29–31, 57, 116

K

K. *See* Number of exposures remaining

L

L. *See* Image size
Landscapes. *See*  (landscape mode)

Language, 84, 121

Language (setup menu), 84

LCD brightness (setup menu), 83

Lens, 1, 8, 97–98, 122
AF-S/AF-I, 1, 8, 97

non-CPU, 97–98

Lighting. *See* Flash; White balance

Long time-exposures, 44

Low-pass filter, 86, 105
cleaning, 105

M

M. *See* Image size

M. *See* Manual mode

Manual mode, 39, 43–44

Mass storage. *See* USB, Mass storage

Matrix. *See* Metering

Memory buffer, 32, 116

Memory card, 12–13, 81, 102, 116

approved, 102

capacity, 116

formatting, 12–13, 81

lock, 13

 (menu) button, 3, 63–64

Menus, 63–95. *See also* **CSM/Setup menu**

using, 63–64

Metering, 45–46, 75

Mirror, 86, 104, 105

Mirror lock-up (setup menu), 86, 105

Mode, 4. *See also* Aperture-priority auto; Auto mode; Digital Vari-Program; Programmed auto; Manual mode; Shutter-priority auto

Monitor, 3, 6, 50, 104

auto off, 14, 78

brightness of, 83

Monochrome, 88, 92. *See also*

Black and white

Monochrome (retouch menu), 92

Moving subjects. *See*  (sports mode); Focus, autofocus, mode

N

ND. *See* Filter, Neutral Density (ND)

NEF (RAW). *See* Image quality, NEF (RAW)

Neutral Density. *See* Filter, Neutral Density (ND)

Night photography. *See*  (night portrait mode)

Noise, 37, 44, 73, 76. *See also*

Noise reduction

Noise reduction (shooting menu), 73

No memory card? (Custom Settings menu), 75

Non-CPU lens. *See* Lens, non-CPU

NORMAL. *See* Image quality

Number of exposures remaining, 5, 6, 15

O

Optimize image (shooting menu), 68–69

Options. *See* Accessories, optional

P

P. *See* Programmed auto

PictBridge, 57–61, 117

PictureProject, 31, 55–56, 57, 88, 103

Picture Transfer Protocol. *See* USB, PTP

 (flexible program indicator), 5, 40

Playback, 20, 50–54

full frame, 20, 50

menu, 65–67

thumbnail, 52

zoom, 53

Playback folder (playback menu), 66

Portraits. *See*  (portrait mode);  (night portrait mode); **Optimize image**

PRE. *See* White balance, preset

Printing, 57–61. *See also* PictBridge; **Print set (DPOF)**

Print set (DPOF) (playback menu), 60–61, 67

Programmed auto, 39, 40

Protecting photographs, 54

PTP. *See* USB, PTP

Q

Quality. *See* Image quality

R

RAW. *See* Image quality, NEF (RAW)

Rear curtain sync. *See* Flash, mode

Red eye correction (retouch menu), 91

Red-eye reduction. *See* Flash, mode

Remote. *See* Accessories, optional; Shooting mode, delayed remote; Shooting mode, quick-response remote

Remote control, 32–33, 103

Remote on duration (Custom Settings menu), 79

Reset. *See* **Reset**

Reset (Custom Settings menu), 74

Retouch menu, 89–95

Rotate tall (playback menu), 66

Rotating photographs, 66, 88

S

S. *See* Image size

S. *See* Shutter-priority auto

 (single-frame shooting indicator), 32

Saturation, 68–69

SD. *See* Memory card

Secure Digital. *See* Memory card

Self timer. *See* Shooting mode, self timer

Self-timer (Custom Settings menu), 79

Self-portraits. *See* Remote control; Self timer

Sensitivity. *See* ISO sensitivity

Sepia. *See* **Monochrome**

Setup menu, 80–88

Sharpening, 69

Shooting information display, 6, 22, 81–83

Shooting menu, 68–73

Shooting mode, 32–33, 75, 77
continuous, 32

delayed remote, 32–33
quick-response remote, 32–33

self timer, 32–33, 77

single frame, 32

Shutter, 17, 41

speed, 6, 39–44. *See also* Exposure

Shutter-priority auto, 39, 41

Single area AF. *See* Focus, AF-area mode

Single frame. *See* Shooting mode, single frame

Single-servo autofocus. *See*

Focus, autofocus, mode

Size. *See* Image size

Slide show. *See* **Slide show**

Slide show (playback menu), 67

Slow sync. *See* Flash mode

Small picture (retouch menu), 92–93

Speedlight. *See* Flash

Spot. *See* Metering

sRGB. *See* Color mode

T

Television, 62, 103

Time, 11, 83. *See also* Clock; **World time**

Time exposure. *See* Long time exposures

Thumbnail. *See* Playback, thumbnail

Trim (retouch menu), 91

Tone compensation, 69

Two-button reset, 38

U

USB, 55–56, 57–58, 84

cable, 55–56, 57–58

Mass storage, 55, 84

PTP, 55, 84

USB (setup menu), 55, 84

V

Video cable, 62, 103

Video device, 62

Video mode (setup menu),
62, 83

VIDEO OUT, 2, 62

Viewfinder, 5, 14, 16, 102, 111–
112

accessories, 102

focus, 14

indicators, 5, 111–112

Viewing photographs. *See*
Playback

W

WB (white balance indicator), 6,
49, 70–72

White balance, 49, 70–72. *See*
also Color temperature
preset, 49, 70–72

White balance (shooting
menu), 49, 70–72

World time (setup menu), 11,
83



Nikon

No reproduction in any form of this manual, in whole or in part (except for brief quotation in critical articles or reviews), may be made without written authorization from NIKON CORPORATION.

NIKON CORPORATION

Fuji Bldg., 2-3 Marunouchi 3-chome,
Chiyoda-ku, Tokyo 100-8331, Japan

Printed in Thailand
6MBA7511-02